

Order no. 6522 0079 13  
Part no. 451 584 60 00  
Edition B-2015



[www.smart.com](http://www.smart.com)

smart - A Daimler brand

Operator's Manual smart fortwo coupé and smart fortwo cabriolet



>> **Operator's Manual.**  
smart fortwo coupé and smart fortwo cabriolet



## Symbols

Trademarks®:

- Bluetooth® is a registered trademark of Bluetooth SIG Inc.
- ESP® is a registered trademark of Daimler.
- iPod® is a registered trademark of Apple Inc., registered in the U.S.A. and other countries.

The following symbols are found in this Operator's Manual:

- \* Optional equipment is identified with an asterisk. Since standard equipment varies between models, the descriptions and illustrations in this Operator's Manual may differ slightly from the actual equipment of your vehicle.

### WARNING

Warning notices draw your attention to hazards that may endanger your health or life, or the health or life of others.

 Highlights hazards that may result in damage to your vehicle.

 Helpful hints or further information you may find useful.

- ▶ This symbol points to instructions for you to follow.
- ▶ A number of these symbols appearing in succession indicates a multiple-step procedure.

▷ page This symbol tells you where you can find additional information on a topic within this Operator's Manual.

▷ ▷ This continuation symbol marks a warning or procedure which is continued on the next page.

**Display** Text in displays, such as the control system displays, are printed in the type shown here.

## Service and Literature

Your authorized smart center has trained technicians and Genuine smart Parts to service your vehicle properly.

For expert advice and quality service, contact an authorized smart center.

For further information you can find us on the smart web-site [www.smartusa.com](http://www.smartusa.com) (USA only) or [www.thesmart.ca](http://www.thesmart.ca) (Canada only).

### WARNING

To help avoid personal injury, be extremely careful when performing any service work or repairs. Improper or incomplete service or the use of incorrect or inappropriate parts or materials may damage the vehicle or its equipment, which may in turn result in personal injury.

If you have any questions about carrying out any type of service, turn to the advice of an authorized smart center.

We reserve the right to make changes in design and equipment.

Therefore, information, illustrations and descriptions in this Operator's Manual might differ from your vehicle.

Reprinting, translation and copying, even of excerpts, is not permitted without our prior authorization in writing.

## Let the fun begin!

Take a moment to familiarize yourself with your smart fortwo coupé or smart fortwo cabriolet and read through the Operator's Manual before driving. This will ensure you get more fun out of your vehicle – and avoid danger to yourself and others.

This Operator's Manual contains very important information about how to safely and effectively operate the vehicle. It is important to note that this is a unique vehicle. It is obviously smaller than most vehicles on the road and, for this reason, it can provide both unique experiences and special responsibilities. It is extremely important that you read this entire Manual and that you familiarize yourself with how the vehicle works. Some of the features may be different from the features on other compact passenger vehicles. Should you have any questions about the vehicle and how to safely operate its features, please use common sense and contact smart dealer representatives, who are available to help you.

smart is a vehicle manufactured by Daimler, distributed in the United States by Mercedes-Benz USA LLC, and in Canada by Mercedes-Benz Canada, and sold and serviced by independent, authorized smart centers.

Because of this vehicle's unique characteristics, we strongly recommend that you service and maintain the vehicle only at authorized smart service facilities. A list of service facilities is available by calling smart Customer Assistance representatives at:

1-800-762-7887 (in the USA)

1-877-627-8004 (in Canada)

Although we cannot prevent you from servicing the vehicle at facilities other than smart authorized facilities, this is not advisable.

Optional extras are identified with an asterisk\*. The equipment in your vehicle

may vary depending on the model, version and availability. smart is constantly bringing its vehicles up to the very latest state of the art and reserves the right to modify them in form, equipment and engineering.

Should you find that a particular feature in this manual is important to your decision to purchase the vehicle, we recommend that you personally check the vehicle to ensure that this feature has been installed before buying the vehicle.

The Operator's Manual and Scheduled Maintenance Guide/Warranty Booklet (USA only) or Service/Warranty Booklet (Canada only) belong to the vehicle. You should always keep these documents in the vehicle and make sure you pass them on to the next owner if and when you sell your smart.

Please contact an authorized smart center if you have any further questions.

The Technical Documentation team at Daimler wishes you many happy hours at the wheel.

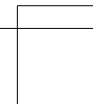
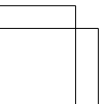
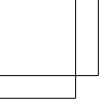

<b>Index</b> .....	4	<b>At a glance</b> .....	19
<b>Introduction</b> .....	13	<b>Safety</b> .....	29
		<b>Controls</b> .....	51
		<b>Operation</b> .....	115
		<b>Practical hints</b> .....	157
		<b>Technical data</b> .....	211

## A

<b>ABS (Antilock Brake System)</b> .....	46
Indicator lamp .....	163
<b>Accessory weight</b> .....	140
<b>Accidents</b>	
Air bags .....	33
<b>Additives</b>	
Engine oil .....	221
Gasoline .....	222
<b>Address change</b> .....	15
<b>Air bags</b> .....	33
Children .....	33
Front, driver and passenger .....	36
Front, passenger .....	36
Head-thorax .....	37
Knee bag .....	36
Passenger front air bag off indicator lamp .....	27, 41
Safety guidelines .....	35
SRS indicator lamp .....	166
Thorax-pelvis .....	37
Window curtain .....	37
<b>Air conditioning</b>	
see HVAC .....	102
<b>Air conditioning refrigerant</b> .....	221
<b>Air pressure</b>	
see Tire inflation pressure	
<b>Air pressure (tires)</b> .....	141
<b>Air vents</b> .....	104
<b>Alarm system</b>	
see Anti-theft systems	
<b>Ambient lighting*</b> .....	68
<b>Anti-theft systems</b> .....	48
Anti-theft warning system .....	48
Electronic immobilizer .....	48
Interior motion sensor .....	49
Tow-away alarm .....	49
<b>Anticorrosion/antifreeze</b> .....	223
<b>Antiglare, Interior rear view mirror</b> .....	62
<b>Antilock Brake System</b>	
see ABS	
<b>Aquaplaning</b>	
see Hydroplaning	
<b>Armrest</b> .....	59
<b>Aspect ratio (tires)</b> .....	141

<b>Audio system</b> .....	98
Basic .....	99
Navigation/multimedia .....	99
<b>Automatic headlamp mode</b> .....	65
<b>Automatic locking</b> .....	53
<b>Automatic transmission</b> .....	81
Display message .....	159
Driving tips .....	83
Emergency operation (limp- home mode) .....	85
Gear selector lever .....	81
Gear selector lever positions .....	83
Gearshift pattern .....	81
Hill-start assist system .....	84
Manual gearshifting .....	84
Shifting procedure .....	82
<b>AUX socket</b> .....	99
<b>Auxiliary instruments</b>	
Cockpit clock .....	91
Tachometer .....	91

## B

<b>Backrest</b>	
see Seats	
<b>Backup lamp</b> .....	180
<b>Bar (air pressure unit)</b> .....	141
<b>Battery</b>	
Charging .....	196
Indicator lamp .....	168
Jump starting .....	199
Removing and installing .....	196
<b>Battery (key)</b>	
Replacing the transmitter bat- tery .....	177
<b>Bead (tire)</b> .....	141
<b>Brake fluid</b> .....	123
Checking .....	123
<b>Brake lamp</b> .....	180
<b>Brake pedal</b> .....	80
<b>Brakes</b> .....	145
Parking brake .....	79
Warning lamp .....	164
<b>Break-in period</b> .....	116
<b>Bulbs</b>	
Front .....	179
Rear .....	180
Replacing .....	178

## C

<b>CAC (Customer Assistance Center)</b> .....	16
<b>California retail buyers and lessees, important notice for</b> .....	14
<b>Can holder</b>	
see Cup holder	
<b>Cargo compartment cover blind</b> .....	107
<b>Catalytic converter</b> .....	147
<b>CD player</b> .....	98
<b>Center console</b> .....	26
<b>Central locking</b>	
Automatic .....	53
Locking/unlocking from inside ....	54
<b>Certification label</b> .....	214
<b>Child safety</b>	
see Children in the vehicle	
<b>Children in the vehicle</b> .....	42
Air bags .....	33
Indicator lamp, passenger front air bag off .....	41, 173
Infant and child restraint systems .....	42
OCS (Occupant Classification System) .....	39
Safety notes .....	42
Tether anchorage points .....	44
<b>Cigarette lighter</b> .....	114
<b>Climate control</b>	
see HVAC .....	102
<b>Clock</b> .....	88
<b>Cockpit</b> .....	20
<b>Coin holder</b> .....	110
<b>Cold tire inflation pressure</b> .....	141
<b>Combination switch</b> .....	66
<b>Control system</b>	
Consumption menu .....	95
Control lever .....	93
Introduction .....	92
Menus and submenus .....	94
Messages menu .....	96
Multifunction display .....	93
Odometer menu .....	94
Reset menu .....	95
Settings menu .....	96
Start menu .....	95
Time menu .....	97

## Coolant

Anticorrosion/antifreeze .....	223
Capacities .....	220
Checking level .....	122
Temperature warning lamp .....	170
<b>Coolant temperature</b> .....	150
<b>Copyright</b> .....	18
<b>Cruise control</b> .....	100
<b>Cup holder</b> .....	107
<b>Curb weight</b> .....	141
<b>Customer Assistance Center (CAC)</b> .....	16

## D

## Dashboard

    see Instrument cluster

<b>Daytime running lamp mode</b> .....	66
--	----

## Deep water

    see Standing water

## Defroster

Rear window .....	106
Windshield .....	106

## Department of Transportation

    see DOT

## Dimensions (vehicle)

    see Vehicle specification

<b>Direction of rotation (tires)</b> .....	134
--	-----

## Display messages

Automatic transmission .....	159
Electronic immobilizer .....	159

<b>Door control panel</b> .....	27
---------------------------------	----

<b>Door handles</b> .....	27
---------------------------	----

## Doors

Locking/unlocking from outside ...	53
Opening from inside .....	54

## DOT (Department of Transportation)

.....	139, 141
-------	----------

<b>Drinking and driving</b> .....	144
-----------------------------------	-----

## Driving

Abroad .....	151
Coolant temperature .....	150
Hydroplaning .....	148
In winter .....	149
Instructions .....	77, 144
Safety systems .....	45
Through standing water .....	149
Tips, automatic transmission .....	83

<b>Driving and parking</b>	
Safety notes .....	77
<b>Driving safety systems</b> .....	45
ABS .....	46
ESP® .....	46
Hydraulic brake assistant .....	47

## E

<b>Electrical system</b>	
Improper work on or modifica-	
tions .....	15
Power outlet .....	114
<b>Electronic immobilizer</b> .....	48
Display message .....	159
<b>Electronic Power Steering</b>	
see EPS	
<b>Electronic Stability Program</b>	
see ESP®	
<b>Emergency operation (limp-home</b>	
<b>mode)</b> .....	85
<b>Emergency Tensioning Device</b>	
see ETD	
<b>Emergency, in case of</b>	
Hazard warning flasher .....	48, 69
Roadside Assistance .....	14
<b>Emission control</b> .....	150
Information label .....	213
System warranties .....	13
<b>Engine</b>	
Break-in recommendations .....	116
Compartment .....	117
Compartment cover .....	117
Electronics .....	212
Malfunction indicator lamp .....	170
Number .....	214
Starting .....	77
Turning off .....	81
<b>Engine coolant</b>	
see Coolant	
<b>Engine oil</b>	
Adding .....	119
Additives .....	221
Checking level .....	118
Consumption .....	118
Oil dipstick .....	119
<b>EPS (Electronic Power Steering)</b>	
Warning lamp .....	167

<b>ESP® (Electronic Stability Program)</b> ..	46
Warning lamp .....	167
<b>ETD (Emergency Tensioning Device)</b> ...	33
Safety guidelines .....	35
<b>Exterior lamp switch</b> .....	64
<b>Exterior lighting</b>	
Overview .....	179
<b>Exterior rear view mirrors</b> .....	61

## F

<b>Flat tire</b> .....	186
<b>Fluids</b>	
Capacities .....	220
Engine coolant .....	220
Engine oil .....	220
<b>Fog lamps</b> .....	68, 179
<b>Front air bags</b>	
see Air bags	
<b>Front compartment</b> .....	120
<b>Front lamps</b>	
Overview .....	179
<b>Fuel</b> .....	146
Additives .....	222
Capacity, fuel tank .....	220
Fuel filler flap and cap .....	116
Fuel level display .....	89
Premium unleaded gaso-	
line .....	117, 220, 221
Refueling .....	116
Requirements .....	221
<b>Fuel cap</b>	
Indicator lamp .....	169
<b>Fuel filler flap</b> .....	116
<b>Fuel level display</b> .....	89
<b>Fuel tank</b>	
Capacity .....	220
Fuel filler flap and cap .....	116
Refueling .....	116
<b>Fuse chart</b> .....	207
<b>Fuses</b> .....	205

## G

<b>Gasoline</b>	
see Fuel	
<b>GAWR (Gross Axle Weight Rating)</b> .....	141



<b>Gear selector lever</b> .....	81
Transmission positions .....	83
<b>Global locking/unlocking</b> .....	53
<b>Glove box</b> .....	110
<b>Gross Axle Weight Rating</b>	
see GAWR	
<b>Gross Vehicle Weight</b>	
see GVW	
<b>Gross Vehicle Weight Rating</b>	
see GVWR	
<b>GVW (Gross Vehicle Weight)</b> .....	141
<b>GVWR (Gross Vehicle Weight Rating)</b> ..	141

## H

<b>Halogen headlamps</b>	
see Headlamps	
<b>Hazard warning flasher</b> .....	69
<b>Head-thorax air bags</b> .....	37
<b>Headlamps</b>	
Automatic headlamp mode .....	65
Daytime running lamp mode .....	66
High-beam flasher .....	67
High-beam headlamps .....	67
Low-beam headlamps .....	65
Switch .....	64
<b>Heated exterior rear view mirrors</b> .....	62
<b>Heating</b>	
see HVAC .....	102
<b>Height adjustment</b>	
Seats .....	59
<b>High-beam flasher</b> .....	67
<b>High-beam headlamps</b> .....	67, 179
Indicator lamp .....	169
<b>High-mounted brake lamp</b> .....	180
<b>Hill-start assist system</b> .....	84
<b>HVAC (Heating, Ventilation, Air Conditioning)</b> .....	102
Air distribution .....	105
Air recirculation .....	107
Air vents .....	104
Air volume .....	106
Defrosting .....	106
Rear window defroster .....	106
Temperature .....	104
<b>Hydraulic brake assistant</b> .....	47
<b>Hydroplaning</b> .....	148

## I

<b>Identification labels</b> .....	213
<b>Identification number, vehicle (VIN)</b> .....	214
<b>Infant and child restraint systems</b>	
see Children in the vehicle	
<b>Inflation pressure</b>	
see Tires, Inflation pressure	
<b>Inside door handle</b> .....	54
<b>Instrument cluster</b> .....	21, 23
Illumination .....	92
Lamps, indicator and warning .....	162
<b>Instrument panel</b>	
see Instrument cluster	
<b>Instruments and controls</b>	
see Cockpit	
<b>Interior motion sensor</b> .....	49
<b>Interior rear view mirror</b> .....	62
<b>Interior storage spaces</b>	
see Storage compartments	
<b>Intermittent wiping</b>	
Rear window wiper .....	71
Windshield wipers .....	70

## J

<b>Jump-starting</b> .....	199
----------------------------	-----

## K

<b>Key</b> .....	52
Loss of .....	174
Replacing the transmitter battery .....	177
<b>Kilopascal (air pressure unit)</b> .....	141
<b>Knee bag</b> .....	36

## L

<b>Labels</b> .....	213
Emission control information .....	213
<b>Lamps, exterior</b>	
Exterior lamp switch .....	64
Switching on/off .....	64
<b>Lamps, indicator and warning</b>	
ABS .....	163
Battery .....	168
Brakes .....	164

- Coolant temperature ..... 170
  - Engine malfunction ..... 170
  - EPS ..... 167
  - ESP® ..... 167
  - Fog lamps ..... 68
  - Fuel cap ..... 169
  - High-beam headlamps ..... 169
  - Low tire pressure/TPMS malfunction telltale ..... 171
  - Low-beam headlamps ..... 169
  - Oil pressure ..... 171
  - Overview (kilometers) ..... 24
  - Overview (miles) ..... 22
  - Passenger front air bag off ... 36, 173
  - Seat belt telltale ..... 165
  - SRS ..... 166
  - Turn signals ..... 169
  - License plate lamps** ..... 180
  - Lighter**  
see Cigarette lighter
  - Lighting** ..... 64
    - Ambient lighting\* ..... 68
    - Coming home function ..... 67
    - Daytime running lamp mode ..... 66
    - Exterior ..... 64
    - Interior ..... 69
  - Loading**  
see Vehicle loading
  - Locking the vehicle** ..... 52
    - Manually ..... 176
  - Loss of**
    - Key ..... 174
    - Service and Warranty Information booklet ..... 212
  - Low-beam headlamps** ..... 65, 179
    - Exterior lamp switch ..... 64
    - Indicator lamp ..... 169
    - Switching on ..... 65
- M**
- Main odometer display** ..... 87
  - Maintenance** ..... 14
    - Service interval display ..... 90
  - Malfunction**
    - Electronic immobilizer ..... 159
    - Shifting system ..... 159
  - Manual headlamp mode (Low-beam headlamps)** ..... 65
  - Maximum load rating (tires)** ..... 141
  - Maximum loaded vehicle weight** ..... 141
  - Maximum permissible tire inflation pressure** ..... 141
  - Mirrors**
    - Exterior rear view mirrors ..... 61
    - Interior rear view mirror ..... 62
  - MON (Motor Octane Number)** ..... 221
  - Motor Octane Number**  
see MON
  - Multifunction display** ..... 86
- N**
- Normal occupant weight** ..... 142
  - Number, vehicle identification (VIN)** ..... 214
- O**
- Occupant Classification System**  
see OCS (Occupant Classification System)
  - Occupant distribution** ..... 142
  - Occupant safety**
    - Air bags ..... 33
    - Children and air bags ..... 33
    - Children in the vehicle ..... 42
    - Infant and child restraint systems ..... 42
    - Introduction ..... 30
    - OCS (Occupant Classification System) ..... 39
    - Passenger front air bag off indicator lamp ..... 39
    - Seat belts ..... 31, 35
    - SRS indicator lamp, malfunction . 166
  - OCS (Occupant Classification System)** ..... 39
    - Self-test ..... 41
  - Oil**  
see Engine oil
  - Oil level**  
see Engine oil, Checking level
  - On-board Diagnostics Socket (OBD)** ... 213
  - Operating safety** ..... 15

Outside temperature display .....	89
Overhead control panel .....	27

## P

Paintwork care .....	155
Panic alarm .....	45
Parcel nets .....	107, 111
Parking .....	79
Parking brake .....	79
Parking lamps .....	179
Parts service .....	212
<b>PASS AIR BAG OFF indicator lamp</b>	
see Passenger front air bag off indicator lamp	
<b>Passenger front air bag</b> .....	36
<b>Passenger front air bag off indicator lamp</b> .....	27, 36, 173
<b>Passenger safety</b>	
see Occupant safety	
<b>Passenger seat</b> .....	60
<b>Pedals</b> .....	144
<b>Power assistance</b> .....	144
<b>Power outlet</b> .....	114
<b>Power washer</b> .....	154
<b>Practical hints</b>	
Battery .....	196
Display messages .....	158
Flat tire .....	186
Fuses .....	205
Jump starting .....	199
Replacing bulbs .....	178
Replacing transmitter battery ....	177
Replacing wiper blades .....	184
Towing .....	202
Unlocking/locking manually .....	176
Warning and indicator lamps .....	162, 173
What to do if .....	162
Where will I find...? .....	158
<b>Premium unleaded gasoline</b> .....	221
<b>Problems with your vehicle</b> .....	16
<b>Product information</b> .....	13
<b>Production options weight</b> .....	142
<b>PSI (air pressure unit)</b> .....	142

## R

<b>Radio</b> .....	98
<b>Radio transmitters</b> .....	150
<b>Rain-light sensor</b> .....	70
<b>Rear lamps</b>	
Overview .....	180
<b>Rear window defroster</b> .....	106
<b>Rear window wiper/washer</b> .....	71
Replacing wiper blade .....	184
<b>Recommended tire inflation pressure</b> .....	125, 142
<b>Refrigerant, air conditioning</b> .....	221
<b>Refueling</b> .....	116
<b>Remote control</b>	
see Key	
<b>Replacing bulbs</b> .....	178
<b>Reporting safety defects</b> .....	16
<b>Research Octane Number</b>	
see RON	
<b>Reserve fuel indicator</b> .....	91
<b>Restraint systems</b>	
see Occupant safety	
<b>Rims</b> .....	142, 216
<b>Roadside Assistance</b> .....	14
<b>RON (Research Octane Number)</b> .....	221
<b>Roof</b>	
see Soft top system	

## S

<b>Safety</b>	
Driving safety systems .....	45
Occupant safety .....	30
Reporting defects .....	16
<b>Safety belts</b>	
see Seat belts	
<b>Seat belt force limiter</b> .....	33
<b>Seat belts</b> .....	31
Children in the vehicle .....	42
Fastening .....	62
Proper use of .....	31
Safety guidelines .....	35
Safety notes .....	31
Telltale .....	165
<b>Seat heating</b> .....	60
<b>Seating capacity</b> .....	131

- Seats** ..... 58
    - Adjustment ..... 59
    - Armrest ..... 59
    - Heating ..... 60
    - Passenger seat ..... 60
  - Self-test**
    - OCS (Occupant Classification System) ..... 41
    - SRS ..... 30
  - Service**
    - see Maintenance
  - Service and warranty**
    - Booklet ..... 212
  - Service flap** ..... 120
  - Service interval display** ..... 90
  - Service life (tires)** ..... 134
  - Service, parts** ..... 212
  - Side marker lamps** ..... 179
  - Side windows**
    - Operation ..... 76
  - Sidewall (tires)** ..... 142
  - Signs and labels** ..... 213
  - smart surround sound system** ..... 100
  - Snow chains** ..... 143
  - Snow tires**
    - see Winter tires
  - Soft top system** ..... 71
    - Cleaning the soft top fabric ..... 155
    - Locking rear soft top manually .... 177
    - Mounting the side rails ..... 75
    - Opening and closing the rear soft top ..... 56, 73
    - Opening and closing the retractable soft top ..... 56, 72
    - Removing the side rails ..... 74
    - Storing the side rails ..... 75
  - Sound package** ..... 100
  - SRS (Supplemental Restraint System)**
    - Indicator lamp ..... 166
  - Standing water, driving through** ..... 149
  - Starter switch positions** ..... 57
  - Starting the engine** ..... 77
  - Status indicator** ..... 90
  - Steering wheel gearshift control** ..... 25
  - Storage compartments** ..... 109
    - Coin holder ..... 110
    - Door pockets ..... 110
    - Drawer ..... 111
    - Glove box ..... 110
    - in the tailgate ..... 111
    - Parcel nets ..... 111
    - Storage tray in center console ..... 111
    - Storage trays next to steering wheel ..... 110
  - Storing tires** ..... 135
  - Sun screen** ..... 113
  - Sun visors** ..... 113
- T**
- Tail lamps** ..... 180
  - Tailgate**
    - Closing ..... 55, 57
    - Opening ..... 54, 56
  - Technical data**
    - Air conditioning refrigerant ..... 221
    - Brake fluid ..... 221
    - Coolant ..... 223
    - Engine oil additives ..... 221
    - Engine oils ..... 220
    - Fuel requirements ..... 221
    - Gasoline additives ..... 222
    - Identification labels ..... 213
    - Premium unleaded gasoline ..... 221
    - Rims and tires ..... 216
    - Service fluids and capacities ..... 218
    - Vehicle specification (model BRABUS) ..... 216
    - Vehicle specification (model passion) ..... 215
    - Vehicle specification (model pure) ..... 215
    - Windshield/rear window washer system ..... 220, 222
  - Technical data (dimensions)**
    - see Vehicle specification
  - Technical data (weights)**
    - see Vehicle specification
  - Temperature**
    - Coolant ..... 150
    - Interior temperature ..... 104
    - Outside ..... 89
  - Tether anchorage points**
    - see Children in the vehicle

- Thorax-pelvis side air bags** ..... 37
  - Tightening torque**
    - Wheels ..... 136
  - TIN (Tire Identification Number)** ..... 139, 142
  - Tire and Loading Information placard** ..... 130
  - Tire and loading terminology** ..... 140
  - Tire Identification Number**
    - see TIN
  - Tire inflation pressure**
    - Checking ..... 127
    - Important notes on ..... 126
    - Placard on driver's door B-pillar ..... 130
  - Tire labeling** ..... 136
  - Tire load rating** ..... 142
  - Tire ply composition and material used** ..... 142
  - Tire Pressure Monitoring System (TPMS)** ..... 127
  - Tire repair kit** ..... 158, 186
  - Tire speed rating** ..... 138, 142
  - Tires** ..... 124, 216
    - Air pressure ..... 125
    - Care and maintenance ..... 134
    - Cleaning ..... 135
    - Direction of rotation, spinning .. 134
    - Driving instructions ..... 147
    - Flat tire ..... 186
    - Important notes on tire inflation pressure ..... 126
    - Inflation pressure ..... 126, 127
    - Information placard ..... 130
    - Inspection ..... 134
    - Labeling ..... 136
    - Load rating ..... 142
    - Ply composition and material used ..... 142
    - Problems under-/overinflation .. 126
    - Retreads ..... 124
    - Rims and tires (technical data) ... 216
    - Rotation ..... 136
    - Service life ..... 134
    - Sizes ..... 216
    - Snow chains ..... 143
    - Speed rating ..... 138, 142, 148
    - Storing ..... 135
    - Temperature ..... 126, 136
    - Terminology ..... 140
    - Tire Identification Number .. 139, 142
    - Tire Pressure Monitoring System (TPMS) ..... 127
    - Traction ..... 135, 142, 148
    - Tread ..... 142
    - Tread depth ..... 134, 143
    - Treadwear indicators ..... 134, 143
    - Vehicle maximum load on ..... 143
    - Wheel change ..... 194
    - Winter tires ..... 143, 216
  - Top tether**
    - see Children in the vehicle
  - Total load limit** ..... 142
  - Tow-away alarm** ..... 49
  - Towing** ..... 202
  - Traction** ..... 142, 148
  - Transmission**
    - see Automatic transmission
  - Transmission position indicator** ..... 87
  - Transmitting power values** ..... 212
  - Traveling abroad** ..... 151
  - Tread (tires)** ..... 142
  - Tread depth (tires)** ..... 134, 143
  - Treadwear indicators (tires)** ..... 134, 143
  - Trip odometer, resetting** ..... 90
  - Turn signal lamps** ..... 179
  - Turn signals** ..... 67
    - Indicator lamps ..... 169
  - Turning off the engine** ..... 81
- ## U
- Uniform Tire Quality Grading Standards** ..... 135, 143
  - Unleaded gasoline, premium** ..... 221
  - Unlocking the vehicle** ..... 52
    - Manually ..... 176
  - USB socket** ..... 99
- ## V
- Vehicle**
    - Bulbs ..... 178
    - Care ..... 151
    - Data acquisition ..... 17

- Identification Number (VIN) ..... 214
  - Locking/unlocking ..... 52
  - Modifications and alterations,
    - Operating safety ..... 15
    - Towing ..... 202
    - Unlocking/locking manually ..... 176
  - Vehicle dimensions**
    - see Vehicle specification
  - Vehicle Identification Number (VIN)** ..... 214
  - Vehicle lighting** ..... 64
  - Vehicle loading**
    - Instructions ..... 112
    - Load limit ..... 131
    - Roof rack ..... 112
    - Terminology ..... 140
  - Vehicle maximum load on the tire** .... 143
  - Vehicle specification**
    - Model BRABUS ..... 216
    - Model passion ..... 215
    - Model pure ..... 215
  - Vehicle washing**
    - see Vehicle care
  - Vehicle weights**
    - see Vehicle specification
  - Ventilation**
    - see HVAC ..... 102
- W**
- Warning signals**
    - Anti-theft warning system ..... 175
    - Brake pads ..... 176
    - Door ..... 175
    - Parking ..... 176
    - Seat belt reminder system .... 165, 175
  - Warranty coverage** ..... 212
  - Warranty information** ..... 13
  - Washer fluid**
    - Mixing ratio ..... 222
    - Refilling ..... 123
    - Wiping ..... 71
  - Washer jet nozzles** ..... 186
  - Washing the vehicle** ..... 151
  - Weights (vehicle)**
    - see Vehicle specification
  - Wheel change** ..... 194
  - Wheel cover** ..... 194
  - Wheels, sizes** ..... 216
  - Wheels, Tires and** ..... 124
  - Where will I find...?**
    - Tire repair kit ..... 158
  - Window curtain air bags** ..... 37
  - Windshield**
    - Washer fluid ..... 71, 222
    - Wipers ..... 70
  - Windshield wipers** ..... 70
    - Adjusting washer jet nozzles ..... 186
    - Rain-light sensor ..... 70
    - Replacing wiper blades ..... 184
  - Winter driving**
    - Driving instructions ..... 149
    - Snow chains ..... 143
    - Tires ..... 143
  - Winter tires** ..... 143, 216

### Product information

We recommend using Genuine smart Parts as well as conversion parts and accessories explicitly approved by smart for your vehicle model.

We have tested these parts to determine their reliability, safety and special suitability for smart vehicles.

We are unable to make an assessment for other products and therefore cannot be held responsible for them, even if in individual cases an official approval or authorization by governmental or other agencies should exist. Use of such parts and accessories could adversely affect the safety, performance or reliability of your vehicle. We strongly recommend that you not use them.

Genuine smart Parts as well as conversion parts and accessories approved by us are available at your authorized smart center where you will receive comprehensive information about use and installation of appropriate parts.

### Operator's Manual

This Operator's Manual contains a great deal of useful information. We urge you to read it carefully and familiarize yourself with the vehicle before driving.

For your own safety and longer service life of the vehicle, we urge you to follow the instructions and warnings contained in this manual. Ignoring them could result in damage to the vehicle or personal injury to you or others. Vehicle damage caused by failure to follow instructions is not covered by the smart Limited Warranty.

Your vehicle may have some or all of the equipment described in this manual. Therefore, you may find explanations for optional equipment not installed in your vehicle. If you have any questions about the operation of any equipment, your author-

ized smart center will be glad to demonstrate the proper procedures.

We continuously strive to improve our product, and ask for your understanding that we reserve the right to make changes in design and equipment. Therefore, information, illustrations and descriptions in this Operator's Manual might differ from your vehicle.

Optional equipment is also described in this manual, including operating instructions wherever necessary. Since they are special-order items, the descriptions and illustrations herein may vary slightly from the actual equipment of your vehicle.

If there are any equipment details that are not shown or described in this Operator's Manual, your authorized smart center will be glad to inform you of correct care and operating procedures.

The Operator's Manual and Maintenance/Warranty Booklet (USA only) or Service/Warranty Booklet (Canada only) are important documents and should be kept with the vehicle.

### Warranty information

The smart USA Warranty booklet (USA only) or the Warranty booklet (Canada only) contains detailed information about the warranties covering your smart, including:

- smart USA Limited Warranty (USA only)
- New Vehicle Limited Warranty (Canada only)
- Emission System Warranty
- Emission Performance Warranty
- Corrosion Warranty
- California, Connecticut, Maine, Massachusetts, New York, Pennsylvania, Rhode Island, and Vermont Emission Control System Warranty
- smartmove Assistance (Canada only)
- State Warranty Enforcement Laws (Lemon Laws, USA only)

### Important notice for California retail buyers and lessees of smart automobiles

Under California law you may be entitled to a replacement of your vehicle or a refund of the purchase price or lease price, if Mercedes-Benz USA LLC and/or its authorized repair or service facilities fail to fix one or more substantial defects or malfunctions in the vehicle that are covered by its express warranty after a reasonable number of repair attempts. During the period of 18 months from original delivery of the vehicle or the accumulation of 18000 miles (approximately 29000 km) on the odometer of the vehicle, whichever occurs first, a reasonable number of repair attempts is presumed for a retail buyer or lessee if one or more of the following occurs:

- (1) the same substantial defect or malfunction results in a condition that is likely to cause death or serious bodily injury if the vehicle is driven, that defect or malfunction has been subject to repair two or more times, and you have directly notified Mercedes-Benz USA LLC in writing of the need for its repair,
- (2) the same substantial defect or malfunction of a less serious nature than category (1) has been subject to repair four or more times and you have directly notified us in writing of the need for its repair, or
- (3) the vehicle is out of service by reason of repair of the same or different substantial defects or malfunctions for a cumulative total of more than 30 calendar days.

Written notification should not be sent to a dealer, it should be addressed to:

Mercedes-Benz USA LLC  
One Mercedes Drive  
Montvale, NJ 07645

### Maintenance

The Scheduled Maintenance Guide (USA) and Service Booklet (Canada) describes all the necessary maintenance work which should be performed at regular intervals. It is important that you service your vehicle in accordance with the prescribed maintenance schedule. Failure to do so may render your vehicle unsafe, it may affect the durability of the vehicle, and it may otherwise void the limited, express warranty.

Always have the Scheduled Maintenance Guide (USA) or Service Booklet (Canada) with you when you take the vehicle to your authorized smart center for service. The service advisor will record each service in the booklet for you.

### Roadside Assistance

The smartmove Assistance (Canada) and smart 1 service (USA) Program provides factory trained technical help in the event of a breakdown. Calls to the toll-free Roadside Assistance number

**1-800-762-7887 (in the USA)**

**1-877-627-8004 (in Canada)**

will be answered by smart Customer Assistance Representatives 24 hours a day, 365 days a year.

Roadside Assistance will be provided in accordance with standard program guidelines which include providing service to the vehicle up to a reasonable distance from a paved roadway. We will make every effort to assist in a breakdown situation, however, the accessibility of your vehicle will be determined by our authorized smart center technician or the tow service provider on a case-by-case basis and may be a factor in our ability to respond.

Additional charges may be applicable for a breakdown location determined not to be a reasonably accessible roadside location as determined by our authorized technician and tow service provider.



For additional information refer to the smart Roadside Assistance Program brochure (USA) or the Warranty Booklet (Canada) in your vehicle literature portfolio.

### Change of address or ownership

In the USA: If you change your address, be sure to send in the "Information Change Card" found in the Warranty Information Booklet.

In Canada: If you change your address, be sure to send in the "Change of Address Notice" found in the Warranty Booklet, or simply call the Customer Service at 1-800-387-0100.

Maintaining your current address information with smart will enable us to contact you should important new information about the vehicle, such as recalls, become available.

If you sell your smart, please leave all literature with the vehicle to make it available to the next operator.

In the USA: If you bought this vehicle used, be sure to send in the "Information Change Card" found in the Warranty Information Booklet.

In Canada: If you bought this vehicle used, be sure to send in the "Notice of Pre-Owned Vehicle Purchase" found in the Warranty Booklet, or call the Customer Service at 1-800-387-0100.

### Operating your vehicle outside the USA or Canada

If you plan to operate your vehicle in foreign countries, please be aware that:

- Service facilities or replacement parts may not be readily available.
- Unleaded gasoline for vehicles with catalytic converters may not be available;

the use of leaded fuels will damage the catalyts.

- Gasoline may have a considerably lower octane rating, and improper fuel can cause engine damage.

### Operating safety

#### WARNING

Work improperly carried out on electronic components and associated software could cause them to cease functioning. Because the vehicle's electronic components are interconnected, any modifications made may produce an undesired effect on other systems. Electronic malfunctions could seriously impair the operating safety of your vehicle.

See an authorized smart center for repairs or modifications to electronic components.

Improper work or modifications on other vehicle systems could also have a negative impact on the operating safety of the vehicle.

#### WARNING

Some safety systems only function while the engine is running. You should therefore never turn off the engine while driving.

#### WARNING

Heavy blows against the vehicle underbody or tires/wheels, for example when running over an obstacle, road debris or a pothole, may cause serious damage and impair the operating safety of your vehicle.

If you feel a sudden significant vibration or ride disturbance, or you suspect that damage to your vehicle has occurred, you should turn on your hazard warning flashers, carefully slow down, and drive with caution to an area which is a safe distance from the road.

Inspect the vehicle underbody and tires/wheels for possible damage. If the vehicle appears unsafe, have it towed to the nearest authorized smart center or other qualified maintenance or repair facility for further inspection or repairs.

### Proper use of the vehicle

Proper use of the vehicle requires that you are familiar with the following information and rules:

- the safety precautions in this manual
- the "Technical data" section in this manual
- traffic rules and regulations
- motor vehicle laws and safety standards

#### WARNING

Various warning labels are attached to your vehicle. These warning labels are intended to make you and others aware of various risks. You should not remove any of these warning labels unless explicitly instructed to do so by information on the label itself. Removal of any of these labels may cause you and others to be unaware of certain risks which may result in an accident and/or personal injury.

### Problems with your vehicle

If you should experience a problem with your vehicle, particularly one that you believe may affect its safe operation, we urge you to immediately contact an authorized smart center to have the problem diagnosed and corrected if required. Do not drive the vehicle if you believe it may not be safely operated. If the matter is not handled to your satisfaction, please discuss the problem with the smart center management, or if necessary contact us at one of the following addresses:

In the USA:

Mercedes-Benz USA LLC

One Mercedes Drive

Montvale, NJ 07645

In Canada:

Customer Relations Department

98 Vanderhoof Avenue

Mercedes-Benz Canada, Inc.

Toronto, Ontario, M4G 4C9

### Reporting safety defects

For the USA only: The following text is published as required of manufacturers under Title 49, Code of U.S. Federal Regulations, Part 575 pursuant to the National Traffic and Motor Vehicle Safety Act of 1966.

If you believe that your vehicle has a defect which could cause a crash or could cause injury or death, you should immediately inform the National Highway Traffic Safety Administration (NHTSA) in addition to notifying Mercedes-Benz USA LLC.

If NHTSA receives similar complaints, it may open an investigation, and if it finds that a safety defect exists in a group of vehicles, it may order a recall and remedy campaign. However, NHTSA cannot become involved in individual problems between you, your dealer, or Mercedes-Benz USA LLC.

To contact NHTSA, you may call the Vehicle Safety Hotline toll-free at 1-888-327-4236 (TTY: 1-800-424-9153); go to <http://www.safercar.gov>; or write to: Administrator, NHTSA Headquarters, 1200 New Jersey Avenue, SE, West Building, Washington, DC 20590. You can also obtain other information about motor vehicle safety from <http://www.safercar.gov>.

## Vehicle data recording

### Data recording

This vehicle is capable of recording diagnostic information relating to vehicle operation, malfunctions, and user settings. This may include information about the performance or status of various systems, including but not limited to, engine, throttle, steering or brake systems, that is stored and can be read out with suitable devices, particularly when the vehicle is serviced. The data obtained is used to properly diagnose and service your vehicle or to further optimize and develop vehicle functions.

### Event data recorders

This vehicle is equipped with an event data recorder (EDR). The main purpose of an EDR is to record data that will assist in understanding how a vehicle's systems performed in certain crash or near crash-like situations, such as during air bag deployment or when hitting a road obstacle. The EDR is designed to record data related to vehicle dynamics and safety systems for a short period of time, typically 30 seconds or less.

The EDR in this vehicle is designed to record such data as:

- how various systems in your vehicle are operating
- whether or not the driver and passenger seat belts are fastened
- how far (if at all) the driver is depressing the accelerator and/or brake pedal and
- how fast the vehicle is traveling

This data can help provide a better understanding of the circumstances in which crashes and injuries occur. **NOTE:** EDR data is recorded by your vehicle only if a non-trivial crash situation occurs; no data is recorded by the EDR under normal driving

conditions and no personal data (e.g., name, gender, age, and crash location) are recorded. However, other parties, such as law enforcement, can combine the EDR data with the type of personal identification data routinely acquired during a crash investigation.

To read data recorded by an EDR, special equipment is required, and access to the vehicle or the EDR is needed. In addition to the vehicle manufacturer, other parties that have the special equipment, such as law enforcement, can read the information by accessing the vehicle or the EDR.

EDR data may be used in civil and criminal matters as a tool in accident reconstruction, accident claims, and vehicle safety. Since the Crash Data Retrieval CDR tool that is used to extract data from the EDR is commercially available, Mercedes-Benz USA, LLC ("MBUSA") expressly disclaims any and all liability arising from the extraction of this information by unauthorized Mercedes-Benz personnel.

MBUSA will not share EDR data with others without the consent of the vehicle owners or, if the vehicle is leased, without the consent of the lessee. Exceptions to this representation include responses to subpoenas by law enforcement; by federal, state or local government; in connection with or arising out of litigation involving MBUSA or its subsidiaries and affiliates; or, as required by law.

**Warning:** The EDR is a component of the Restraint System Module. Tampering with, altering, modifying or removing the EDR component may result in a malfunction of the Restraint System Module and other systems.

State laws or regulations regarding EDRs that conflict with federal regulation are pre-empted. This means that in the event of such conflict, the federal regulation governs. As of February 2013, 13 states have enacted laws relating to EDRs.

**Information on copyright****General information**

Information on license for free and open-source software used in your vehicle and its electronic components is available on the following website:

<http://www.mercedes-benz.com/opensource>



Cockpit .....	20
Instrument cluster (miles) .....	21
Instrument cluster (kilometers) .....	23
Steering wheel gearshift control .....	25
Center console .....	26
Overhead control panel .....	27
Door control panel .....	27

>> At a glance.

## Cockpit

&gt;&gt; At a glance.

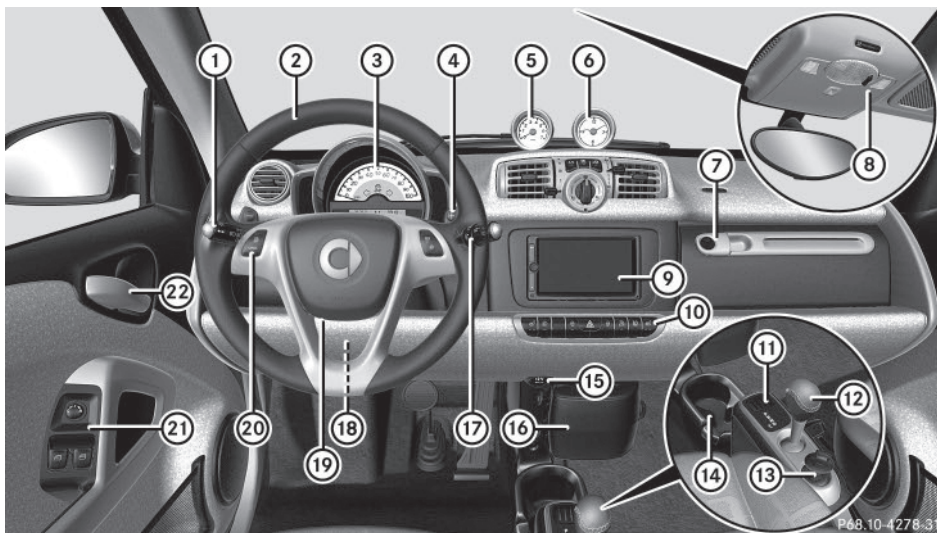

P48.10-4278-31

	Function	Page
①	Exterior lamp switch	64
②	Steering wheel <sup>1</sup>	
③	Instrument cluster	21
④	Steering wheel gearshift control	84
⑤	Tachometer*	91
⑥	Cockpit clock*	92
⑦	Glove box	110
	AUX/USB sockets*	100
⑧	Overhead control panel	27
⑨	Audio system*	98
⑩	Center console switches	26
⑪	Coin holder	110
	Retractable soft top switch <sup>2</sup>	73

	Function	Page
⑫	Gear selector lever	81
⑬	Starter switch	57
⑭	Cup holder	107
⑮	Auxiliary power outlet	114
⑯	Storage tray*	111
⑰	Wiper switch	70
	Cruise control switch*	100
	Control lever (control system)*	93
⑱	On-board Diagnostics Socket (OBD)	213
⑲	Horn	
⑳	Cruise control buttons*	100
㉑	Door control panel	27
㉒	Inside door handle	54

<sup>1</sup> Model pure only: The steering wheel in this vehicle varies from steering wheel illustrated.

<sup>2</sup> cabriolet only.

\* optional

Instrument cluster (miles)

Miles

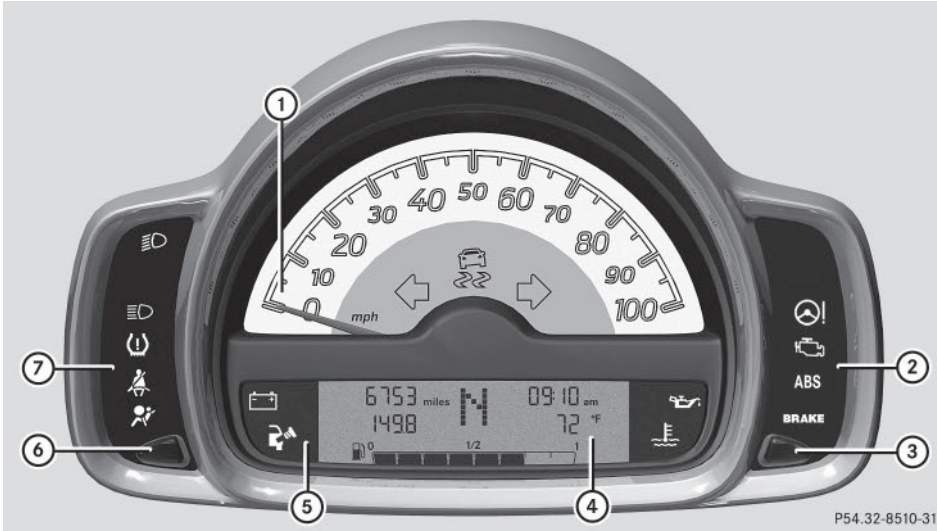

>> At a glance.

Instrument cluster (U.S. vehicles)

	Function	Page		Function	Page
①	Speedometer		⑤	Center indicator and warning lamp display	22
②	Right indicator and warning lamp display	22	⑥	Selecting display for status indicator	90
③	Adjusting instrument cluster illumination	92		Setting digital clock	88
	Adjusting ambient lighting*	68	⑦	Left indicator and warning lamp display	22
	Setting digital clock	88			
④	Multifunction display	86			







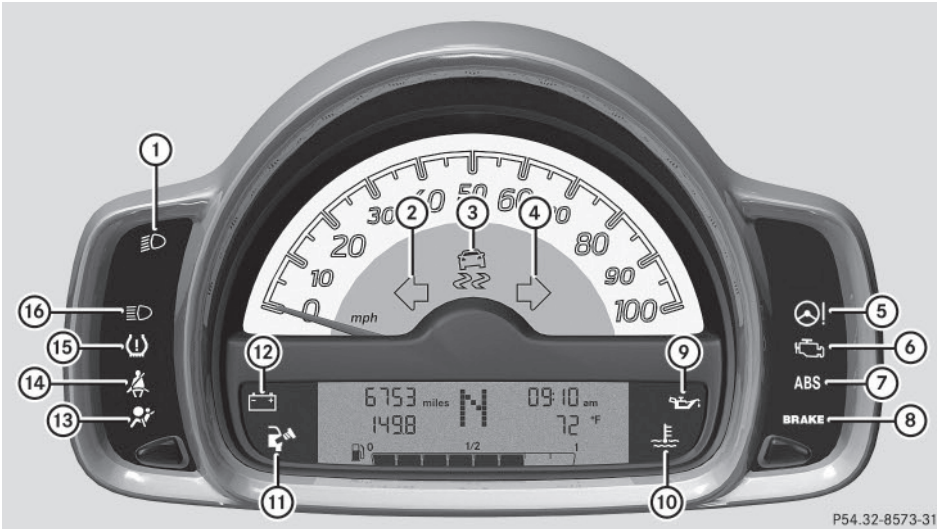

\* optional







## Indicator and warning lamps

&gt;&gt; At a glance.



P54.32-8573-31

	Function	Page
①	 Low-beam head-lamp indicator lamp	65, 169
②	 Left turn signal indicator lamp	67, 169
③	 ESP® warning lamp	167
④	 Right turn signal indicator lamp	67, 169
⑤	 EPS* warning lamp	167
⑥	 Engine malfunction indicator lamp	170
⑦	 ABS indicator lamp	163
⑧	 BRAKE Brake warning lamp	164
⑨	 Engine oil pressure indicator lamp	171

	Function	Page
⑩	 Coolant temperature warning lamp	170
⑪	 Fuel cap indicator lamp	169
⑫	 Battery indicator lamp	168
⑬	 SRS indicator lamp	166
⑭	 Seat belt telltale	165
⑮	 Combination low tire pressure/TPMS malfunction telltale*	171
⑯	 High-beam head-lamp indicator lamp	67, 169

\* optional



## Instrument cluster (kilometers)

## Kilometers

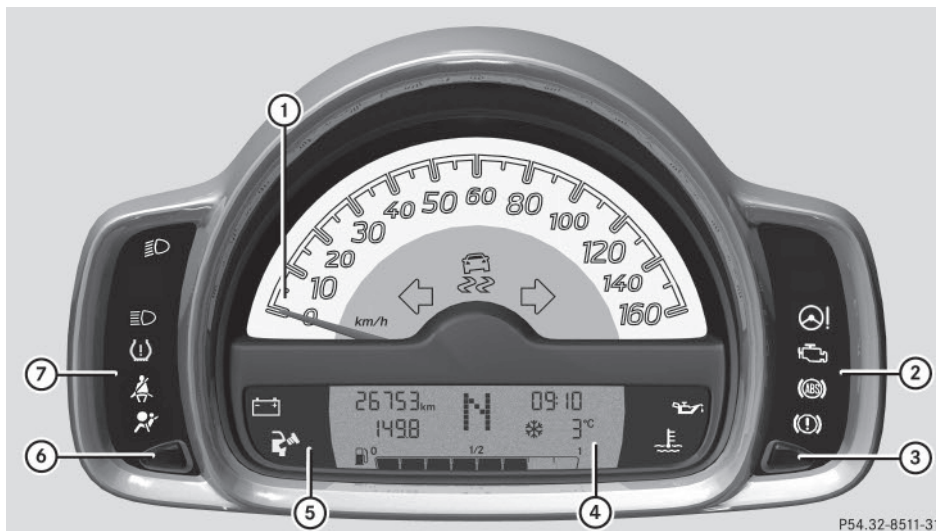

P54.32-8511-31

&gt;&gt; At a glance.

## Instrument cluster (Canada vehicles)

	Function	Page		Function	Page
①	Speedometer		⑤	Center indicator and warning lamp display	24
②	Right indicator and warning lamp display	24	⑥	Selecting display for status indicator Setting digital clock	90 88
③	Adjusting instrument cluster illumination Adjusting ambient lighting*	92 68	⑦	Left indicator and warning lamp display	24
	Setting digital clock	88			
④	Multifunction display	86			







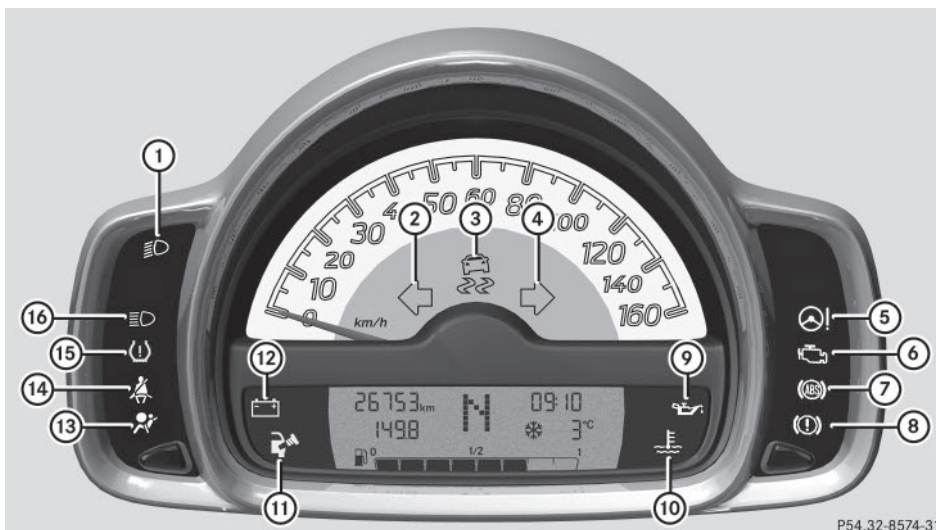

\* optional







## Indicator and warning lamps

&gt;&gt; At a glance.



P54.32-8574-31

	Function	Page
①	 Low-beam head-lamp indicator lamp	65, 169
②	 Left turn signal indicator lamp	67, 169
③	 ESP® warning lamp	167
④	 Right turn signal indicator lamp	67, 169
⑤	 EPS* warning lamp	167
⑥	 Engine malfunction indicator lamp	170
⑦	 ABS indicator lamp	163
⑧	 Brake warning lamp	164
⑨	 Engine oil pressure indicator lamp	171

	Function	Page
⑩	 Coolant temperature warning lamp	170
⑪	 Fuel cap indicator lamp	169
⑫	 Battery indicator lamp	168
⑬	 SRS indicator lamp	166
⑭	 Seat belt telltale	165
⑮	 Combination low tire pressure/TPMS malfunction telltale*	171
⑯	 High-beam head-lamp indicator lamp	67, 169

\* optional

## Steering wheel gearshift control



P46 10-3149-31

	Function	Page
①	Multifunction display	86
②	Right shift paddle <sup>3</sup> : Upshift	85
③	Left shift paddle <sup>3</sup> : Down- shift	85

**i** Model pure only:

The steering wheel in this vehicle varies from steering wheel illustrated.

>> At a glance.

<sup>3</sup> Model passion and BRABUS only.

&gt;&gt; At a glance.

## Center console

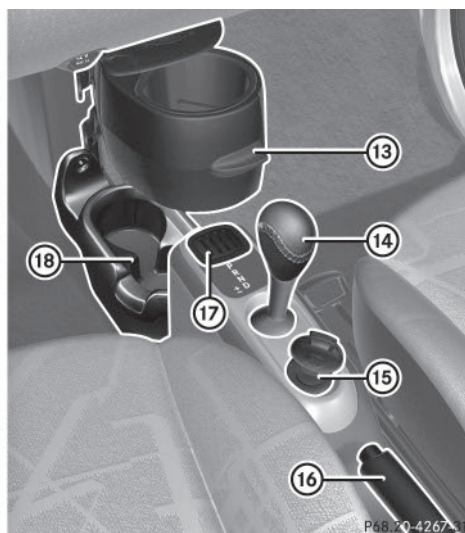
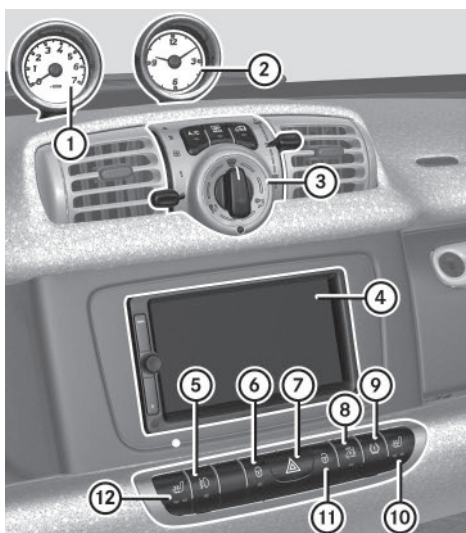

	Function	Page
①	Tachometer*	91
②	Cockpit clock*	92
③	HVAC	102
④	Audio system*	98
⑤	Switching front fog lamps* on/off	68
⑥	Central locking switch	54
⑦	Hazard warning flasher switch	69
⑧	Switching tow-away protection*/interior motion sensor* on/off	49
⑨	Restarting TPMS button	127

	Function	Page
⑩	Switching seat heating* on/off, passenger side	60
⑪	Central unlocking switch	54
⑫	Switching seat heating* on/off, driver's side	60
⑬	Storage tray*	111
⑭	Gear selector lever	81
⑮	Starter switch	57
⑯	Parking brake lever	79
⑰	Coin holder Retractable soft top switch <sup>4</sup>	110 73
⑱	Cup holder	107

<sup>4</sup> cabriolet only.

\* optional

Overhead control panel



	Function	Page
①	Passenger front air bag off indicator lamp	41, 162
②	Switching interior lighting on/off	69
③	Interior rear view mirror	62

Door control panel

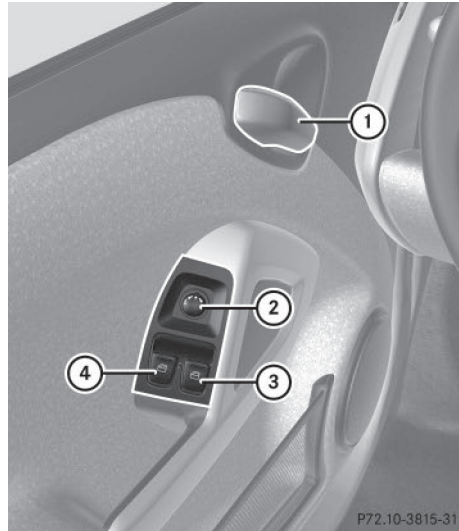

	Function	Page
①	Inside door handle	54
②	Adjusting exterior rear view mirrors: Manually Electrically <sup>5</sup>	61 61
③	Opening and closing right side window: Manually Electrically <sup>5</sup>	76 77
④	Opening and closing left side window: Manually Electrically <sup>5</sup>	76 77

>> At a glance.

<sup>5</sup> Model passion and BRABUS only.





Occupant safety .....	30
Panic alarm .....	45
Driving safety systems .....	45
Anti-theft systems .....	48

**>> Safety.**

## Occupant safety

### Introduction

The smart vehicle is equipped with seat belts and dual stage air bags to protect you in a crash. However, children can be killed or seriously injured by an inflating air bag. Indeed, there is a stronger risk of serious death or bodily injury when an air bag deploys on a child positioned in a rear-facing child seat in the passenger seat. Because this vehicle has only two front seats and no backseat, it is limited as are other two-seat vehicles, in the extent to which it may restrain children traveling in the passenger front seat. Many states have laws against placing children of certain ages in the front seat of a vehicle that has both front and back seats. Those laws make exceptions to permit children to be restrained in the front seat of two seat vehicles. Special instructions and warnings are provided below about when and if you may restrain a child in the passenger seat of the smart vehicle. Under certain circumstances, it is appropriate for the passenger air bag not to operate when a child is restrained in a car seat in the passenger seat, and this vehicle is equipped with technology to accomplish this. Please pay very close attention to the instructions and warnings below, particularly as they relate to children.

In this section you will learn the most important facts about the restraint system components of the vehicle.

The restraint systems are:

- Seat belts (▷ page 31)
- Child restraints (▷ page 42)

Additional protection potential is provided by:

- **Supplemental Restraint System (SRS)** with
  - Air bags (▷ page 33)
  - Air bag control unit (with crash sensors)
  - Emergency Tensioning Devices and seat belt force limiters (▷ page 33)
- Air bag system components with
  - Passenger front air bag off indicator lamp (▷ page 41)
  - Passenger seat with **Occupant Classification System (OCS)** (▷ page 39)

Although independent systems, their protective functions work in conjunction with each other.

- **i** For information on infants and children traveling with you in the vehicle and restraint systems for infants and children, see “Children in the vehicle” (▷ page 42).

The SRS system conducts a self-test when the ignition is switched on and in regular intervals while the engine is running. This facilitates detection of malfunctions. The SRS indicator lamp  in the instrument cluster comes on when the ignition is switched on and goes out after approximately four seconds.

The SRS components are in operational readiness if the SRS indicator lamp  is not lit when the engine is running.

A malfunction in the system has been detected if the SRS indicator lamp .

- fails to go out after approximately 4 seconds after the ignition was switched on
- does not come on at all
- comes on after the engine was started or while driving

### **WARNING**

Modifications to or work improperly conducted on restraint systems (such as seat



belts and anchors, Emergency Tensioning Devices, seat belt force limiters or air bags) or their wiring, as well as tampering with interconnected electronic systems, can lead to the restraint systems no longer functioning as intended. Air bags or Emergency Tensioning Devices, for example, could deploy inadvertently or fail to deploy in accidents in which they otherwise should deploy (although the deceleration threshold for air bag deployment is exceeded). Therefore, never modify the restraint systems. Do not tamper with electronic components or their software.

 **WARNING**

In the event that the SRS indicator lamp  comes on while driving or does not come on at all, the SRS self-check has detected a malfunction. For your safety, we strongly recommend that you immediately but safely pull the vehicle off of the roadway and stop driving. Contact an authorized smart center immediately to have the system checked; otherwise the SRS may not deploy when needed in an accident, which could result in serious or fatal injury, or it might deploy unexpectedly and unnecessarily which could also result in injury.

In addition, improper repair work on the SRS creates a risk of rendering the SRS inoperative or causing unintended air bag deployment. Work on the SRS must therefore only be performed by qualified technicians. Contact an authorized smart center. If it is necessary to modify an air bag system to accommodate a person with disabilities, contact your local authorized smart center.

### Seat belts

The use of seat belts and infant and child restraint systems is required by law in all 50 states, the District of Columbia, the U.S.

territories and all Canadian provinces and territories.

Even where this is not the case, all vehicle occupants should have their seat belts fastened whenever the vehicle is being operated.

For more information, see “Fastening the seat belts” (▷ page 62).

-  For information on infants and children traveling with you in the vehicle and restraint systems for infants and children, see “Children in the vehicle” (▷ page 42).

 **WARNING**

Always fasten your seat belt before driving. Always make sure all of your passengers are properly restrained.

Failure to wear and properly fasten and position your seat belt greatly increases your risk of injuries and their likely severity in an accident. You and your passenger should always wear seat belts.

If you are ever in an accident, your injuries can be considerably more severe without your seat belt properly buckled.

Without your seat belt buckled, you are much more likely to hit the interior of the vehicle or be ejected from it. You can be seriously injured or killed.

In the same crash, the possibility of injury or death is lessened if you are properly wearing your seat belt. Air bags can only protect you if you are properly wearing your seat belt.

 **WARNING**

Never ride in a moving vehicle with the seat backrest in an excessively reclined position as this can be dangerous. You could slide under the seat belt in a collision. If you slide under it, the belt would apply force at the abdomen or neck, causing serious or even fatal injuries. The seat backrest and seat belt provide the best restraint when the wearer is in a position

that is as upright as possible and the belt is properly positioned on the body.

 **WARNING**

Never let more people ride in the vehicle than there are seat belts available. Make sure everyone riding in the vehicle is correctly restrained with a separate seat belt. Never use a seat belt for more than one person at a time.

 **WARNING**

Seat belts of a vehicle involved in an accident must be inspected by smart. Only then is it possible to determine whether the seat belts were damaged or stressed in the accident. Damaged or stressed seat belts may not properly protect you in a subsequent accident.

Only use seat belts which have been approved by smart.

Do not make any modifications to the seat belts. This can lead to unintended activation of the Emergency Tensioning Devices (ETDs) or to their failure to activate when necessary.

Do not bleach or dye seat belts as this may severely weaken them. In a crash, they may not be able to provide adequate protection. Have all work carried out only by qualified technicians. Contact an authorized smart center.

 **WARNING**

**USE SEAT BELTS PROPERLY**

- Seat belts can only work when used properly. Never wear seat belts in any other way than as described in this section, as that could result in serious injuries in case of an accident.
- Each occupant should wear their seat belt at all times, because seat belts help reduce the likelihood of and potential severity of injuries in accidents, including rollovers. The integrated restraint system includes SRS (driver

front air bag, passenger front air bag, head-thorax air bags) and Emergency Tensioning Devices (ETDs) with seat belt force limiters.

The system is designed to enhance the protection provided by secured seat belts in certain frontal and side impacts.

- Never wear the shoulder belt under your arm, against your neck or off your shoulder. Doing so may cause your body to move too far forward in a frontal crash, which would increase the chance of head and neck injuries. The seat belt would also apply too much force to the ribs or abdomen, which could severely injure internal organs such as your liver or spleen.
- Never wear seat belts over rigid or breakable objects in or on your clothing, such as eyeglasses, pens, keys, etc., as these might cause injuries.
- Position the lap belt as low as possible on your hips and not across the abdomen. If the lap seat belt is positioned across your abdomen, it could cause serious injuries in a crash.
- Never use a seat belt for more than one person at a time. Do not fasten a seat belt around a person and another person or other objects at the same time.
- Seat belts should not be worn twisted. In a crash, you would not have the full width of the seat belt to manage impact forces. The twisted seat belt against your body could cause injuries.
- Pregnant women should also always use a lap-shoulder belt. The lap belt portion should be positioned as low as possible on the hips to avoid any possible pressure on the abdomen.
- Never place your feet on the instrument panel, dashboard or on the seat. Always keep both feet on the floor in front of the seat.
- When using a seat belt to secure infant or toddler restraints or children in booster

seats, always follow the child seat manufacturer's instructions.

### Emergency Tensioning Devices (ETDs) and seat belt force limiters

The seat belts are equipped with Emergency Tensioning Devices and seat belt force limiters.

Emergency Tensioning Devices are designed to activate in the following cases:

- in frontal or rear-end impacts exceeding the system deployment threshold
- if the restraint systems are operational and functioning correctly
- in collisions with high vehicle deceleration/acceleration in the longitudinal direction, e.g. a head-on collision
- on passenger side when the seat is occupied and the seat belt is fastened
- independently of the front air bags

When activated, Emergency Tensioning Devices remove slack from the seat belts in such a way that the seat belts fit more snugly against the body. Seat belt force limiters, when activated, reduce the force exerted by the seat belts on occupants during a crash.

When the emergency tensioning device is triggered, the SRS indicator lamp  in the instrument cluster illuminates, see "SRS indicator lamp" (> page 166).

#### WARNING

Once they have been triggered, Emergency Tensioning Devices will no longer function properly and must be replaced. smart recommends that you visit a qualified workshop to have this done. In particular, work relevant to safety or on safety-related systems must be carried out at a qualified specialist workshop.

Comply with safety regulations when disposing of Emergency Tensioning Devices.

These regulations are available at any smart center.

The belt force limiter is designed to operate in unison with the front air bag, which absorbs a portion of the seat belt's decelerating forces, distributing the load over a larger area.

In the event of a head-on or rear-end collision, the emergency tensioning device is activated if the vehicle is decelerated or accelerated sufficiently in the longitudinal direction at the start of impact with the ignition switched on.

### Air bags

Air bags can reduce the severity of injuries in serious collisions, e.g. in a head-on collision or a side impact.

#### WARNING

Air bags are designed to reduce the potential of injury in certain frontal impacts (front air bags and knee bags), or side impacts (head-thorax air bags, window curtain air bags and thorax-pelvis air bags) which may cause significant injuries. However, no system available today can completely eliminate injuries and fatalities.

The deployment of the air bags temporarily releases a small amount of dust from the air bags. This dust is neither injurious to your health, nor does it indicate a fire in the vehicle. The dust might cause some temporary breathing difficulty for people with asthma or other breathing trouble. To avoid this, you may wish to get out of the vehicle as soon as it is safe to do so. If you have any breathing difficulty but cannot get out of the vehicle after the air bag inflates, then get fresh air by opening a window or door.

#### WARNING

To reduce the risk of injury when the front air bags inflate, it is very important for

the driver and passenger to always be in a properly seated position and to wear their respective seat belt.

For maximum protection in the event of a collision always be in normal seated position with your back against the backrest. Fasten your seat belt and ensure it is properly positioned on your body.

Since the air bag inflates with considerable speed and force, a proper seating and hands on steering wheel position will help to keep you at a safe distance from the air bag.

Occupants who are unbelted, out of position or too close to the air bag can be seriously injured or killed by an air bag as it inflates extremely quickly and with great force:

- Sit properly belted in a position that is as upright as possible with your back against the seat backrest.
- Adjust the driver's seat as far as possible rearward, still permitting proper operation of vehicle controls. The distance from the center of the driver's breastbone to the center of the air bag cover on the steering wheel must be at least 10 inches (25 cm) or more. You should be able to accomplish this by adjustments to the seat. If you have any problems, please contact an authorized smart center.
- Do not lean your head or chest close to the steering wheel or dashboard.
- Keep hands on the outside of the steering wheel rim. Placing hands and arms inside the rim can increase the risk and potential severity of hand/arm injury when the driver's front air bag inflates.
- Adjust the passenger seat as far as possible rearward from the dashboard when the seat is occupied.
- Occupants, especially children, should never place their bodies or lean their heads in the area of the door where the head-thorax air bag (cabriolet) or thorax-pelvis side air bag (coupé)

inflates. This could result in serious injuries or death should the head-thorax air bag (cabriolet) or thorax-pelvis side air bag (coupé) be deployed. Always sit as upright as possible, wear the seat belt properly and use an appropriately sized infant restraint, toddler restraint, or booster seat recommended for the size and weight of the child.

Failure to follow these instructions can result in severe injuries to you or other occupants.

If you sell your vehicle, it is important that you make the buyer aware of this safety information. Be sure to give the buyer this Operator's Manual.

- i** Air bags are designed to deploy only in certain frontal impacts (front air bags and knee bags), or side impacts (head-thorax air bags, window curtain air bags and thorax-pelvis air bags) which exceed preset thresholds. Only during these events will they provide their supplemental protection.

The driver and passenger should always wear their seat belts. Otherwise it is not possible for air bags to provide their supplemental protection.

In case of other types of impacts and impacts below air bag deployment thresholds, air bags will not deploy. The driver and passenger will then be protected to the extent possible by a properly fastened seat belt. A properly fastened seat belt is also needed to provide the best possible protection in a roll-over.

We caution you not to rely on the presence of the air bags in order to avoid wearing your seat belt.

It is important to your safety and that of your passenger that you replace deployed air bags and repair any malfunctioning air bags to make sure the vehicle will continue to provide supplemental crash protection for occupants.

## Safety guidelines for the seat belt, Emergency Tensioning Devices (ETDs) and air bag

### WARNING

- Damaged seat belts or seat belts that have been highly stressed in an accident must be replaced and their anchoring points must also be checked. Only use seat belts installed or supplied by an authorized smart center.
- Air bags and Emergency Tensioning Devices (ETDs) contain Perchlorate material, which may require special handling and regard for the environment. Check with your local government's disposal guidelines. California residents, see <http://www.dtsc.ca.gov/HazardousWaste/Perchlorate/index.cfm>.
- Given the considerable deployment speed, required inflation volume, and the textile structure of the air bags, there is the possibility of abrasions or other, potentially more serious injuries resulting from air bag deployment.
- Air bags and Emergency Tensioning Devices (ETDs) are designed to function on a one-time-only basis. An air bag or ETD that has deployed must be replaced.
- Do not pass seat belts over sharp edges. They could tear.
- Do not make any modification that could change the effectiveness of the seat belts.
- No modifications of any kind may be made to any components or wiring of the SRS. This includes changing or removing any component or part of the SRS, the installation of additional trim material, badges, etc. over the steering wheel hub, passenger front air bag cover, outboard sides of the seat backrests, and installation of additional electrical/electronic equipment on or near SRS components and wiring. Keep area between air

bags and occupants free from objects (e.g. packages, purses, umbrellas, etc.).

- Do not bleach or dye seat belts as this may severely weaken them. In a crash they may not be able to provide adequate protection.
- Do not hang hangers on the coat hooks or handles over the door. These items may turn into projectiles and cause head and other injuries when the head-thorax air bag is deployed.
- Air bag system components will be hot after an air bag has inflated. Do not touch them.
- Never place your feet on the instrument panel, dashboard, or on the seat. Always keep both feet on the floor in front of the seat.
- In addition, improper repair work on the SRS creates a risk of rendering the SRS inoperative or causing unintended air bag deployment. Work on the SRS must therefore only be performed by qualified technicians. Contact an authorized smart center.
- For your protection and the protection of others, when scrapping the air bag unit or Emergency Tensioning Devices (ETDs), our safety instructions must be followed. These instructions are available from any authorized smart center.

### How an air bag operates

An air bag is inflated in a matter of milliseconds. If an air bag is triggered, the SRS indicator lamp  in the instrument cluster illuminates.

**!** If the air bags are activated, you will hear a loud noise and some dust may be generated. The explosion fundamentally represents no risk to your hearing.

An inflated air bag slows down and reduces the movement of the occupant. When the occupant makes contact with a front air bag or head-thorax air bag (cabriolet only),

hot gas flows out of the inflated front air bags and head-thorax air bags (cabriolet only). This reduces the load on the occupant's head and upper body. These air bags are consequently deflated after the accident.

### Driver front air bag/passenger front air bag

The front air bags are designed to reduce the potential of injury in certain frontal impacts.

Driver front air bag and passenger front air bag are deployed

- at the start of an accident with high vehicle deceleration in the longitudinal direction
- independently of other air bags in the vehicle being deployed
- never in the event of a rollover, unless high vehicle deceleration in the longitudinal direction is detected

**i** The front air bags in this vehicle have been designed to inflate in two stages. This allows the air bag to have different rates of inflation that are based on the rate of relevant vehicle deceleration and a fastened or unfastened seat belt as assessed by the air bag control unit.

On the passenger side, the front air bag deployment is additionally influenced by the passenger's weight category as identified by the Occupant Classification System (OCS) (▷ page 39).

The lighter the passenger side occupant, the higher the vehicle deceleration rate required for the second stage inflation of the air bag.

The air bags will not deploy in impacts which do not exceed the system's deployment thresholds. In such instances, the seat belts are designed to protect you.

The passenger air bag will only be deployed if

- the system, based on OCS weight sensor readings, senses that the passenger seat is occupied and the  PASS AIR BAG OFF indicator lamp is not lit (▷ page 41)
- the impact exceeds a preset deployment threshold

The driver front air bag is located in the steering wheel housing, the passenger front air bag above the glove box.

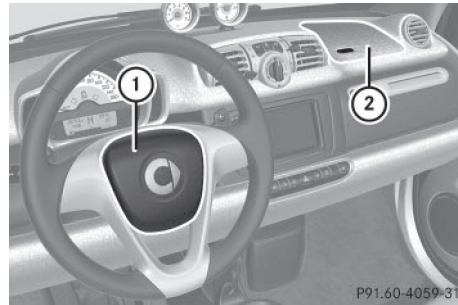

- ① Driver front air bag
- ② Passenger front air bag

### Knee bags

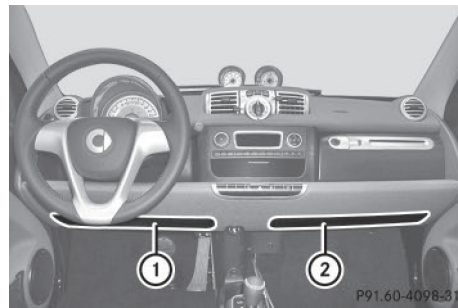

- ① Driver's knee bag
- ② Passenger knee bag

The knee bags are designed to provide increased protection for the driver and passenger against the risk of injuries to the knees, thighs and lower legs. The knee bags are located on the lower instrument panel. They are designed to operate together with the front air bags in certain

frontal impacts if the system determines that air bag deployment can offer additional protection to that provided by the seat belts. Knee bags operate best in conjunction with a properly positioned and fastened seat belts.

### Head-thorax air bags (cabriolet only)

#### **WARNING**

There is a possibility for a head-thorax air bag related injury if occupants, especially children, are not properly seated or restrained when next to a head-thorax air bag which needs to deploy rapidly in a side impact in order to do its job.

To help avoid the possibility of injury, please follow these guidelines:

- (1) Occupants, especially children, should never place their bodies or lean their heads in the area of the door where the head-thorax air bag inflates. This could result in serious injuries or death should the head-thorax air bag be deployed.
- (2) Always sit as upright as possible, properly use the seat belts, and for all children 12 years old or under, use an appropriately sized infant restraint, toddler restraint, or booster seat recommended for the size and weight of the child.
- (3) Always wear seat belts properly.

#### **WARNING**

Only use seat covers which have been tested and approved by smart for your vehicle model. A seat cover must have a deployment control seam for the head-thorax air bag. Using other seat covers may interfere with or prevent the deployment of the head-thorax air bags. Contact an authorized smart center for availability.

If activated, the head-thorax air bags are intended to provide increased protection for the head and thorax (but not arms) of the occupants on the side of the vehicle that is struck.

The head-thorax air bags are deployed

- on the side of the vehicle that is struck (when passenger side is struck only if the seat is occupied)
- at the start of an accident with high vehicle deceleration or acceleration acting in a lateral direction, e.g. a side impact
- regardless of whether or not the seat belt is in use
- independently of the front air bags being deployed
- independently of the emergency tensioning device

The head-thorax air bags are integrated into the driver and passenger seat backrests.

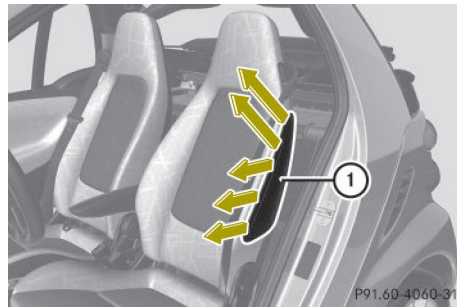

① Head-thorax air bag

### Window curtain air bags and thorax-pelvis side air bags (coupé only)

#### **WARNING**

There is a possibility for a thorax-pelvis side air bag related injury if occupants, especially children, are not properly seated or restrained when next to a thorax-pelvis side air bag which needs to deploy rapidly in a side impact in order to do its job.

To help avoid the possibility of injury, please follow these guidelines:

- (1) Occupants, especially children, should never place their bodies or lean their heads in the area of the door where the thorax-pelvis side air bag inflates. This could result in serious injuries or death should the thorax-pelvis side air bag be deployed.
- (2) Always sit as upright as possible, properly use the seat belts, and for all children 12 years old or under, use an appropriately sized infant restraint, toddler restraint, or booster seat recommended for the size and weight of the child.
- (3) Always wear seat belts properly.

#### WARNING

Only use seat covers which have been tested and approved by smart for your vehicle model. A seat cover must have a deployment control seam for the thorax-pelvis side air bag. Using other seat covers may interfere with or prevent the deployment of the thorax-pelvis side air bags. Contact an authorized smart center for availability.

#### Window curtain air bags

Window curtain air bags are designed to provide increased protection for the head, but not the chest or arms.

Window curtain air bags are deployed

- on the impacted side of the vehicle
- in instances with a high rate of lateral vehicle deceleration or acceleration
- independently of the front air bags
- regardless of whether the passenger seat is occupied
- in a rollover if the system determines that air bag deployment can offer additional protection to that provided by the seat belt.

The window curtain air bags are integrated into the inner side of the roof frame. They run above the doors from the A-pillar to the B-pillar.

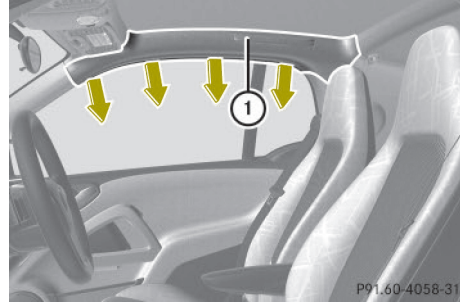

① Window curtain air bags

#### Thorax-pelvis side air bags

Thorax-pelvis side air bags are designed to provide increased protection for the thorax and pelvis, but not the arms.

Thorax-pelvis side air bags are deployed

- on the impacted side of the vehicle
- in instances with a high rate of lateral vehicle deceleration or acceleration
- independently of the front air bags
- regardless of whether the seat belt on the impacted side of the vehicle is in use
- independently of the ETDs.

Thorax-pelvis side air bags will generally not deploy in a rollover.

The thorax-pelvis side air bags will deploy, however, if the system detects

- a high rate of lateral vehicle deceleration or acceleration, and
- that air bag deployment can offer additional protection to that provided by the seat belt.

The thorax-pelvis side air bags are integrated into the driver and passenger seat backrests.



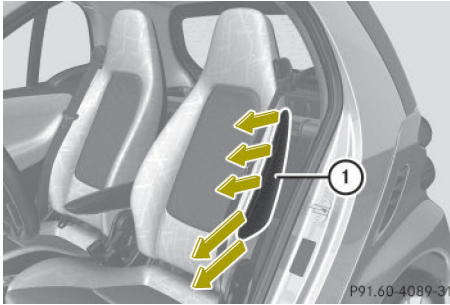

① Thorax-pelvis side air bags

### Occupant Classification System

The **Occupant Classification System (OCS)** automatically turns the passenger front air bag on or off based on the classified occupant weight category determined by weight sensor readings from the passenger seat.



- ❗ Based on the classified occupant weight category determined by weight sensor readings from the passenger seat, the system does also deactivate
  - head-thorax air bag (cabriolet)
  - the window curtain air bag (coupé)
  - the thorax-pelvis side air bag (coupé)
  - the seat Emergency Tensioning Devices
  - the seat belt force limiter.

Occupants must sit properly belted in a position that is as upright as possible with their back against the seat backrest and feet on the floor to be correctly classified. If the occupant's weight is transferred to another object in the vehicle (e.g. by leaning on armrests), the OCS may not be able to properly approximate the occupant's weight category.

- ❗ If the seat, including the trim cover and cushion, needs to be serviced in any way, take the vehicle to an authorized smart center. Only seat accessories approved by smart may be used.

Both driver and the passenger should always use the  **PASS AIR BAG OFF** indicator lamp as an indication of whether or not the passenger is properly positioned (▷ page 41).

### ⚠ WARNING

If the  **PASS AIR BAG OFF** indicator lamp illuminates when an adult or someone larger than a small individual is in the passenger seat, have the passenger re-position himself or herself in the seat until the  **PASS AIR BAG OFF** indicator lamp goes out.

In the event of a collision, the air bag control unit will not allow passenger front air bag deployment when the OCS has classified the passenger seat occupant as being up to or less than the weight of a typical 12-month-old child in a standard child restraint, or if the passenger seat is sensed as being empty.

When the OCS senses that the passenger seat occupant is classified as being up to or less than the weight of a typical 12-month-old child in a standard child restraint, the  **PASS AIR BAG OFF** indicator lamp will illuminate when the ignition is switched on and remain illuminated, indicating that the passenger front air bag is deactivated.

When the OCS senses that the passenger seat is classified as being empty, the  **PASS AIR BAG OFF** indicator lamp will illuminate and remains illuminated.

When the OCS senses that the passenger seat occupant is classified as being heavier than the weight of a typical 12-month-old child seated in a standard child restraint or as being a small individual (such as a young teenager or a small adult), the  **PASS AIR BAG OFF** indicator lamp will illuminate for approximately 4 seconds when the ignition is switched on and then, depending on occupant weight sensor readings from the seat, remains illuminated or goes out.

When the  **PASS AIR BAG OFF** indicator lamp is illuminated, the passenger front air bag is deactivated.

When the  **PASS AIR BAG OFF** indicator lamp is out and the passenger seat is occupied by an adult or someone larger than a small individual, the passenger front air bag is activated.

When the OCS senses that the passenger seat occupant is classified as an adult or someone larger than a small individual, the  **PASS AIR BAG OFF** indicator lamp will illuminate for approximately 4 seconds when the ignition is switched on and then goes out, indicating that the passenger front air bag is activated.

If the  **PASS AIR BAG OFF** indicator lamp is illuminated, the passenger front air bag is deactivated and will not be deployed.

If the  **PASS AIR BAG OFF** indicator lamp is not illuminated, the passenger front air bag is activated and will be deployed

- in the event of certain frontal impacts
- if impact exceeds a preset deployment threshold
- independently of the head-thorax air bags



If the passenger front air bag is deployed, the rate of inflation will be influenced by



- the rate of vehicle deceleration and a fastened or unfastened seat belt as assessed by the air bag control unit
- the passenger's weight category as identified by the OCS

 **WARNING**

Children 12 years old and under must be seated and properly secured in an appropriate infant or child restraint recommended for the size and weight of the child. The infant or child restraint must be properly secured with the vehicle's seat belt, fully in accordance with the child seat manufacturer's instructions.

Children can be killed or seriously injured by an inflating air bag. Note the following important information:

- Your vehicle is equipped with air bag technology designed to turn off the passenger front air bag in your vehicle when the system senses the weight of a typical 12-month-old child or less along with the weight of a standard appropriate child restraint on the passenger seat.
- A child in a rear-facing child restraint on the passenger seat will be seriously injured or even killed if the passenger front air bag inflates in a collision which could occur under some circumstances, even with the air bag technology installed in your vehicle.
- If you install a rear-facing child restraint on the passenger seat, make sure the  **PASS AIR BAG OFF** indicator lamp is illuminated, indicating that the passenger front air bag is deactivated. Should the  **PASS AIR BAG OFF** indicator lamp not illuminate or go out while the restraint is installed, please check installation.

Periodically check the  **PASS AIR BAG OFF** indicator lamp while driving to make sure the  **PASS AIR BAG OFF** indicator lamp is illuminated.

If the  **PASS AIR BAG OFF** indicator lamp goes out or remains out, do not transport a child on the passenger seat until the system has been repaired.

A child in a rear-facing child restraint on the passenger seat may be seriously injured or even killed if the passenger front air bag inflates.

- If you place a child in a forward-facing child restraint on the passenger seat, move the seat as far back as possible, use the proper child restraint recommended for the age, size and weight of the child by the seat manufacturer, and secure child restraint with the vehicle's seat belt according to the child seat manu-

facturer's instructions. For children larger than the typical 12-month-old child, the passenger front air bag may or may not be activated.

- i** Deployment of the driver front air bag does not mean that the passenger front air bag also should have deployed.

The Occupant Classification System may have determined

- that the seat was empty or occupied by the weight up to or less than that of a typical 12-month-old child seated in a standard child restraint – both instances where the system suppresses deployment of the passenger front air bag even though the impact met the criteria and was of sufficient severity to deploy the driver front air bag
- that the seat was occupied by a small individual (such as a young teenager or a small adult) or a child weighing more than the weight of a typical 12-month-old child in a standard child restraint – instances where the system may suppress deployment of the passenger front air bag even though the impact met the criteria and was of sufficient severity to deploy the driver front air bag



### Passenger front air bag off indicator lamp

The indicator lamp is located on the overhead control panel.



Passenger front air bag off indicator lamp ① illuminates when the passenger front air bag is deactivated.



#### **⚠ WARNING**

When the SRS indicator lamp  and the  **PASS AIR BAG OFF** indicator lamp are lit at the same time, there is a malfunction in the Occupant Classification System.

In order to ensure proper operation of the air bag system and OCS:

- Have the system checked as soon as possible by qualified technicians. Contact an authorized smart center.
- Sit properly belted in a position that is as upright as possible with your back against the seat backrest.
- Do not lean on the armrests or lift yourself from the seat by using the handle over the door as this may cause the OCS to be unable to correctly approximate the occupant weight category.
- Only have the seat repaired or replaced by an authorized smart center.
- Read and observe all warnings in this chapter.

### Self-test Occupant Classification System

After turning the key in the starter switch to position 1 or 2, the  **PASS AIR BAG OFF** indicator lamp located in the center console illuminates. If an adult occupant is properly sitting on the passenger seat and the system senses the occupant as being an adult, the  **PASS AIR BAG OFF** indicator lamp will illuminate and go out after approximately 4 seconds.

If the seat is not occupied and the system senses the passenger seat as being empty, the  **PASS AIR BAG OFF** indicator lamp will illuminate and not go out.

#### **⚠ WARNING**

If the  **PASS AIR BAG OFF** indicator lamp does not illuminate immediately after starting

the engine, the system is not functioning. You must contact an authorized smart center before seating any child on the passenger seat.

More information can be found in the "Practical hints" section (> page 173).

 **WARNING**

Never place anything between seat cushion and child seat (e.g. pillow), since it reduces the effectiveness of the Occupant Classification System. The bottom of the child seat must make full contact with the passenger seat cushion. An incorrectly mounted child seat could cause injuries to the child in case of an accident, instead of increasing protection for the child.

Follow the manufacturer's instructions for installation of child seats.

### Children in the vehicle

If an infant or child is traveling with you in the vehicle:

- ▶ Secure the child using an infant or child restraint appropriate to the age and size of the child.
- ▶ Make sure the infant or child is properly secured at all times while the vehicle is in motion.

 **WARNING**

Do not leave children unattended in the vehicle, even if they are secured in a child restraint system. The children could

- injure themselves on parts of the vehicle
- be seriously or fatally injured through excessive exposure to extreme heat or cold

Do not expose the child restraint system to direct sunlight. The child restraint system's metal parts, for example, could become very hot, and the child could be burned on these parts.

If children open a door, they could

- injure other persons
- get out of the vehicle and injure themselves or be injured by following traffic

Do not carry heavy or hard objects in the passenger compartment unless they are firmly secured in place.

For more information, please refer to the "Loading and storing section".

Unsecured or improperly positioned cargo increases a child's risk of injury in the event of

- strong braking maneuvers
- sudden changes of direction
- an accident

### Infant and child restraint system

We recommend all infants and children be properly restrained at all times while the vehicle is in operation.

The passenger lap-shoulder belt has a special seat belt retractor for secure fastening of child restraints.

To fasten a child restraint, follow all mounting instructions provided by the child restraint manufacturer. Then pull the shoulder seat belt out completely and let it retract. During seat belt retraction, a ratcheting sound can be heard to indicate that the special seat belt retractor is activated. The seat belt is now locked. Push down on child restraint to take up any slack.

To deactivate, release seat belt buckle and let seat belt retract completely. To deactivate the special seat belt retractor for the passenger seat, the passenger seat must be in the most backward position. The seat belt can again be used in the usual manner.

 **WARNING**

Never release the seat belt buckle while the vehicle is in motion, since the special seat belt retractor will be deactivated.

The use of infant or child restraints is required by law in all 50 states, the District of Columbia, the U.S. territories, and all Canadian provinces and territories.

Infants and small children should be seated in an appropriate infant or child restraint system properly secured in accordance with the manufacturer's instructions for the child restraint, that complies with U.S. Federal Motor Vehicle Safety Standards 213 and 225 and Canadian Motor Vehicle Safety Standards 213, 213.1 and 213.2.

A statement by the child restraint manufacturer of compliance with these standards can be found on the instruction label on the restraint and in the instruction manual provided with the restraint.

When using any infant restraint, toddler restraint, or booster seat be sure to carefully read and follow all manufacturer's instructions for installation and use.

Please read and observe warning labels affixed to the inside of the vehicle and to infant or child restraints.

 **WARNING**





Children 12 years old and under must be seated and properly secured in an appropriately sized infant restraint, toddler restraint, or booster seat recommended for the size and weight of the child.

The infant or child restraint must be properly secured with the vehicle's seat belt fully in accordance with the child seat manufacturer's instructions.

Occupants, especially children, should never place their bodies or lean their heads in the area of the door where the head-thorax air bags (cabriolet), window curtain air bags (coupé) and thorax-pelvis air bags (coupé) inflates. This could result in serious injuries or death should the head-thorax air bags (cabriolet), window curtain air bags (coupé) and thorax-pelvis air bags (coupé) be triggered. Always sit as upright as possible, properly use the seat belt and use an appropriately sized infant

restraint, toddler restraint, or booster seat recommended for the size and weight of the child.

Children can be killed or seriously injured by an inflating air bag. Note the following important information when circumstances require you to place a child in the passenger seat:

- Your vehicle is equipped with air bag technology designed to turn off the passenger front air bag in your vehicle when the Occupant Classification System senses the weight of a typical 12-month-old child or less along with the weight of an appropriate child restraint on the passenger seat.
- A child in a rear-facing child restraint on the passenger seat may be seriously injured or even killed if the passenger front air bag inflates in a collision.
- If you install a rear-facing child restraint on the passenger seat, make sure the  **PASS AIR BAG OFF** indicator lamp is illuminated, indicating that the passenger front air bag is deactivated. Should the  **PASS AIR BAG OFF** indicator lamp not illuminate or go out while the restraint is installed, please check installation. Periodically check the  **PASS AIR BAG OFF** indicator lamp while driving to make sure the  **PASS AIR BAG OFF** indicator lamp is illuminated. If the  **PASS AIR BAG OFF** indicator lamp goes out or remains out, do not transport a child on the passenger seat until the system has been repaired. A child in a rear-facing child restraint on the passenger seat may be seriously injured or even killed if the passenger front air bag inflates.
- If you place a child in a forward-facing child restraint on the passenger seat, move the seat as far back as possible, use a proper child restraint recommended for the age, size and weight of the child, and secure child restraint with the vehicle's seat belt according to the child seat

manufacturer's instructions. For children larger than the typical 12-month-old child, the passenger front air bag may or may not be activated.

**⚠ WARNING**

Infants and small children should never share a seat belt with another occupant. During an accident, they could be crushed between the occupant and seat belt.

A child's risk of serious or fatal injuries is significantly increased if the child restraints are not properly secured in the vehicle and/or the child is not properly secured in the child restraint.

Children too big for a toddler restraint must ride in a seat using regular seat belt. Position shoulder belt across chest and shoulder, not face or neck. A booster seat may be necessary to achieve proper seat belt positioning for children over 41 lbs until they reach a height where a lap-shoulder belt fits properly without a booster.

When the child restraint is not in use, remove it from the vehicle or secure it with the seat belt to prevent the child restraint from becoming a projectile in the event of an accident.

Do not leave children unattended in the vehicle, even if the children are secured in a child restraint system. Unsupervised children in a child restraint system may use vehicle equipment and may cause an accident and/or serious personal injury.

If you are using a rear-facing child restraint system on the passenger seat, you must verify that the passenger front air bag is deactivated. When the passenger front air bag is deactivated, the  **PASS AIR BAG OFF** indicator lamp is illuminated (▷ page 41).

### Top tether

Top tether permits an additional connection between a child restraint system and the passenger seat. Proper usage of the top

tether, in accordance with instructions provided by the child restraint manufacturer, can further reduce the risk of injuries.

The top tether anchorage is located on the floor of the cargo compartment. The top tether guide for the top tether strap is located above, on the head restraint.

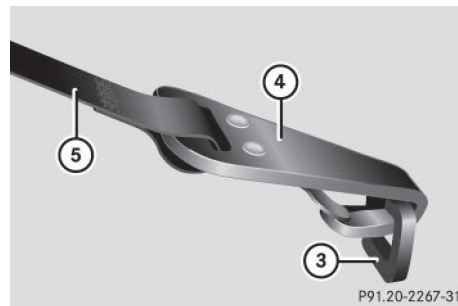
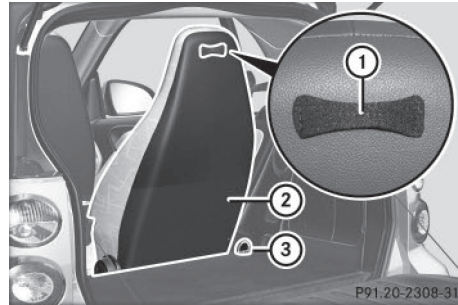

- ▶ Thread top tether strap **⑤** through top tether guide **①** down the back of passenger seat **②** to top tether anchorage **③**.
- ▶ Attach top tether hook **④** to top tether anchorage **③** on the floor of the cargo compartment.
- i** If you are using divider plus\*, the hooks of the top tether and the divider plus\* are attached to the same anchorage.
- ▶ Install the child restraint system and tighten top tether strap **⑤** according to the child restraint manufacturer's instructions.

\* optional

**⚠ WARNING**

After installing top tether straps, make sure the seat backrests are in an upright position and are properly locked. Push and pull on the seat backrests to ensure they are properly secured in the locked position. If a seat backrest is not properly locked, the seat backrest could fold. The child seat would no longer be properly supported or positioned to provide its intended benefit. That could cause serious or even fatal injuries.

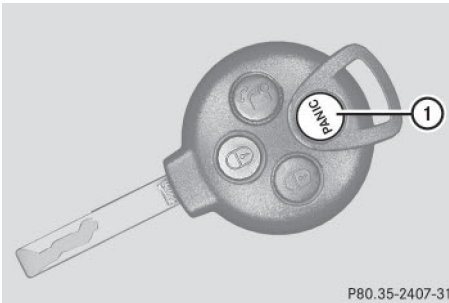
**Panic alarm**

P80.35-2407-31

- ▶ **Activating:** Press and hold button ① for at least 1 second.  
An audible alarm and flashing exterior lamps will operate briefly.
  - ▶ **Deactivating:** Press button ① once more.
- or
- ▶ Insert the key in the starter switch.

**i USA only:**

This device complies with Part 15 of the FCC Rules. Operation is subject to the following two conditions:

1. This device may not cause harmful interference, and
2. this device must accept any interference received, including interference that may cause undesired operation.

Any unauthorized modification to this device could void the user's authority to operate the equipment.

The product label with FCC ID and IC certification number can be found in the battery case.

**i Canada only:**

This device complies with RSS-210 of Industry Canada. Operation is subject to the following two conditions:

1. This device may not cause interference, and
2. this device must accept any interference received, including interference that may cause undesired operation of the device.

Any unauthorized modification to this device could void the user's authority to operate the equipment.

The product label with FCC ID and IC certification number can be found in the battery case.

**Driving safety systems****Introduction****⚠ WARNING**

The following factors increase the risk of accidents:

- Excessive speed, especially in turns
- Wet and slippery road surfaces
- Following another vehicle too closely

The driving safety systems described in this section cannot reduce these risks or prevent the natural laws of physics from acting on the vehicle.

Always adapt your driving style to the prevailing road and weather and traffic conditions and keep a safe distance to other road users and objects on the street.

- i** In winter operation, the maximum effectiveness of the ABS, the hydraulic brake assistant, and the ESP® is only ach-

ieved with winter tires (▷ page 143) or snow chains\* as required.

### Antilock Brake System (ABS)

#### WARNING

Do not pump the brake pedal. Use firm, steady brake pedal pressure instead. Pumping the brake pedal defeats the purpose of the ABS and significantly reduces braking effectiveness.

The **Antilock Brake System (ABS)** regulates the brake pressure so that the wheels do not lock during braking. This allows you to maintain the ability to steer your vehicle. On slippery road surfaces, the ABS will respond even to light brake pressure.

The ABS indicator lamp in the instrument cluster (▷ page 21) comes on when you switch on the ignition. It goes out when the engine is running.

### Braking

At the instant one of the wheels is about to lock up, a slight pulsation can be felt in the brake pedal, indicating that the ABS is regulating the brake pressure.

- ▶ Keep firm and steady pressure on the brake pedal while experiencing the pulsation.

Continuous, steady brake pedal pressure yields the advantages provided by the ABS, namely braking power and the ability to steer the vehicle.

A pulsating brake pedal can be an indication of hazardous road conditions and functions as a reminder to take extra care while driving.

### Emergency brake maneuver

- ▶ Keep continuous full pressure on the brake pedal.

#### WARNING

When the ABS is malfunctioning, the hydraulic brake assistant and the ESP® are also switched off.

When the ABS is malfunctioning, the wheels may lock during hard braking, reducing steering capability and extending the braking distance.

#### WARNING

The ABS cannot prevent the natural laws of physics from acting on the vehicle, nor can it increase braking or steering efficiency beyond that afforded by the condition of the vehicle brakes and tires or the traction afforded. The ABS cannot prevent accidents, including those resulting from excessive speed in turns, following another vehicle too closely, or hydroplaning. Only a safe, attentive, and skillful driver can prevent accidents. The capabilities of an ABS equipped vehicle must never be exploited in a reckless or dangerous manner which could jeopardize the user's safety or the safety of others.

### Electronic Stability Program (ESP®)

Your vehicle is equipped with the **Electronic Stability Program (ESP®)**. The ESP® is operational as soon as the engine is running and it monitors the vehicle's traction (force of adhesive friction between the tires and the road surface) and handling.

The ESP® recognizes when a wheel is spinning or if the vehicle starts to skid. By applying brakes to the appropriate wheel and by limiting the engine output, the ESP® works to stabilize the vehicle. The ESP® is especially useful while driving off and on wet or slippery road surfaces. The ESP® also stabilizes the vehicle during braking and steering maneuvers.



The ESP® warning lamp  in the instrument cluster flashes when the ESP® is engaged.

The ESP® warning lamp  in the instrument cluster comes on when you switch on the ignition. It goes out when the engine is running.

Depending on the driving situation, the ESP®

- reduces the speed
- selectively brakes individual wheels
- equalizes the speed of the driven wheels
- stabilizes the vehicle when braking
- assists you in evasive maneuvers on all roads

#### **WARNING**

If the ESP® warning lamp  in the instrument cluster flashes, proceed as follows:

- While driving off, apply as little throttle as possible.
- While driving, ease up on the accelerator pedal.
- Adapt your speed and driving style to the prevailing road conditions.

Failure to observe these guidelines could cause the vehicle to skid.

The ESP® cannot prevent accidents resulting from excessive speed.

#### **WARNING**

The ESP® cannot prevent the natural laws of physics from acting on the vehicle, nor can it increase the traction afforded. The ESP® cannot prevent accidents, including those resulting from excessive speed in turns, or hydroplaning. Only a safe, attentive, and skillful driver can prevent accidents. The capabilities of an ESP® equipped vehicle must never be exploited in a reckless or dangerous manner which could jeopardize the user's safety or the safety of others.

**!** Because the ESP® operates automatically, the engine must be turned off (ignition switched off) when the parking brake is being tested on a brake test dynamometer. Active braking action through the ESP® may otherwise seriously damage the brake system which is not covered by the smart Limited Warranty.

**i** The ESP® will only function properly if you use wheels of the recommended tire size (▷ page 216).

### Hydraulic brake assistant

The hydraulic brake assistant operates in emergency situations. If you apply the brakes very quickly, the hydraulic brake assistant automatically provides full brake boost, thereby potentially reducing the braking distance.

- ▶ Apply continuous full braking pressure until the emergency braking situation is over.  
The ABS will prevent the wheels from locking.

When you release the brake pedal, the brakes function again as normal. The hydraulic brake assistant is then deactivated.

#### **WARNING**

When the hydraulic brake assistant is malfunctioning, the brake system is still functioning normally, but without the additional brake boost that would normally be provided during an emergency braking maneuver. Therefore, the braking distance may increase.

#### **WARNING**

The hydraulic brake assistant cannot prevent the natural laws of physics from acting on the vehicle, nor can it increase braking efficiency beyond that afforded by the condition of the vehicle brakes and tires or the traction afforded. The hydraulic brake

assistant cannot prevent accidents, including those resulting from excessive speed in turns, following another vehicle too closely, or hydroplaning. Only a safe, attentive, and skillful driver can prevent accidents. The capabilities of a hydraulic brake assistant equipped vehicle must never be exploited in a reckless or dangerous manner which could jeopardize the user's safety or the safety of others.

#### Activating the hazard warning flasher after an emergency braking maneuver

If you bring the vehicle to a complete stop by strongly braking at a speed of more than 43 mph (70 km/h), the hazard warning flasher comes on automatically as soon as the vehicle is at a standstill. The hazard warning flasher will remain on until it is switched off using the hazard warning flasher switch (> page 69) or until the speed of the vehicle has exceeded 6 mph (10 km/h).

### Anti-theft systems

#### Electronic immobilizer

The electronic immobilizer prevents unauthorized persons from starting your vehicle.

When leaving the vehicle, always take the key with you and lock the vehicle. The engine can be started by anyone with a key that is left inside the vehicle.

- ▶ **Activating:** Remove the key from the starter switch.
- ▶ **Deactivating:** Insert the key in the starter switch.
- ▶ Turn the key to starter switch position 1.

#### Anti-theft warning system\*

Once the anti-theft warning system has been armed, a visual and audible alarm is triggered when

- someone opens a door or the tailgate
- someone enters the vehicle's interior
- there is motion inside the vehicle
- someone attempts to raise the vehicle

The alarm will also be triggered when unlocking and opening the driver's door with the key.

- ⓘ The alarm will stay on, even if the driver's door is immediately closed. For canceling the alarm, see (> page 49).

Close the windows and the tailgate before arming the alarm system. Make sure there are no moving objects inside the vehicle.

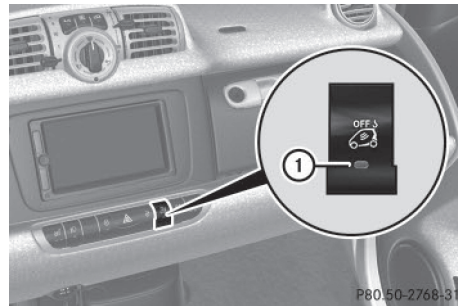



- ▶ **Arming:** Lock the vehicle using the remote control. Warning system indicator lamp ① flashes rapidly. The anti-theft warning system arms after about 25 seconds. When the anti-theft warning system is armed, warning system indicator lamp ① flashes about every three seconds.

- ⓘ You can also arm the anti-theft warning system by locking the vehicle without using the remote control (> page 176).

- ▶ **Disarming:** Unlock the vehicle using the remote control. The anti-theft warning system is disarmed. Warning system indicator lamp ① stops flashing.

\* optional

### Canceling the alarm



- ▶ Insert the key in the starter switch.
  - ▶ Turn the key to starter switch position 1.
- or
- ▶ Press button  or  on the key.

### Tow-away alarm\* and interior motion sensor\*

Once the anti-theft warning system has been armed, a visual and audible alarm is triggered when someone attempts to raise the vehicle or if motion is detected inside the vehicle.

- ▶ **Arming:** Lock the vehicle using the remote control.  
The tow-away protection and the interior motion sensor are armed after about 25 seconds.
- ▶ **Disarming:** Unlock the vehicle using the remote control.  
The tow-away protection and the interior motion sensor are disarmed.

### Canceling the alarm

- ▶ Insert the key in the starter switch.
  - ▶ Turn the key to starter switch position 1.
- or
- ▶ Press button  or  on the key.

### Switching off tow-away protection and interior motion sensor

Switch off the tow-away protection and the interior motion sensor when locking the vehicle and

- transporting the vehicle,
- board, e.g. a ferry or auto train,
- there are people or animals in the vehicle,
- the side windows remain open.

This prevents any false alarm.

\* optional

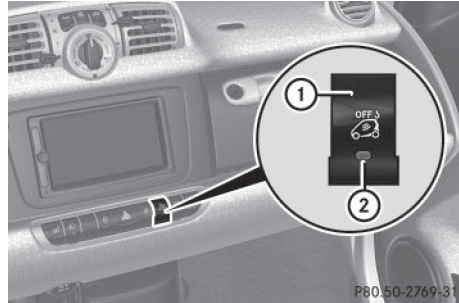

- ▶ Remove the key from the starter switch.
- ▶ Press switch ① within 60 seconds.  
Indicator lamp ② comes on.
- ▶ Exit the vehicle.
- ▶ Lock the vehicle using the remote control.

**i** The tow-away protection and the interior motion sensor remain switched off until you lock your vehicle again.

>> Safety.





Opening and closing .....	52
Starter switch positions .....	57
Seats .....	58
Mirrors .....	61
Seat belts .....	62
Lighting .....	64
Windshield wipers .....	70
Soft top system (cabriolet only) .....	71
Side windows .....	76
Driving and parking .....	77
Transmission .....	81
Instrument cluster .....	86
Control system* .....	92
Audio system* .....	98
Driving systems .....	100
HVAC (Heating, Ventilation, Air Con- ditioning) .....	102
Loading and storing .....	107
Useful features .....	113

**>> Controls.**

## Opening and closing

## Key

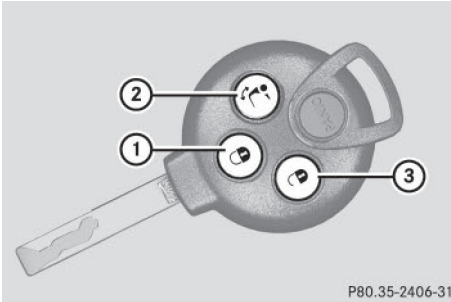

P80.35-2406-31

Key with remote control

- ① Lock button
- ② Opening the retractable soft top<sup>6</sup>/  
unlocking the upper tailgate<sup>7</sup>
- ③ Unlock button

The remote control centrally locks and unlocks:

- the driver's door
- the fuel filler flap
- the passenger door
- the upper tailgate

**WARNING**

When leaving the vehicle, always remove the key from the starter switch, take it with you, and lock the vehicle. Do not leave children unattended in the vehicle, or with access to an unlocked vehicle. It is possible for children to open a locked door from the inside, which could result in an accident and/or serious personal injury.

**!** To prevent possible malfunction, avoid exposing the remote control to high levels of electromagnetic radiation.

**!** If you can no longer lock or unlock the vehicle with the remote control, the batteries in the remote control are dis-

charged, or the remote control is malfunctioning.

- Check the batteries in the remote control and replace them if necessary.
- If you do not have a spare transmitter battery at hand, use the key to open the driver's door and the fuel filler flap.

If the remote control is malfunctioning, contact an authorized smart center.

**i USA only:**

This device complies with Part 15 of the FCC Rules. Operation is subject to the following two conditions:

1. This device may not cause harmful interference, and
2. this device must accept any interference received, including interference that may cause undesired operation.

Any unauthorized modification to this device could void the user's authority to operate the equipment.

The product label with FCC ID and IC certification number can be found in the battery case.

**i Canada only:**

This device complies with RSS-210 of Industry Canada. Operation is subject to the following two conditions:

1. This device may not cause interference, and
2. this device must accept any interference received, including interference that may cause undesired operation of the device.

Any unauthorized modification to this device could void the user's authority to operate the equipment.

The product label with FCC ID and IC certification number can be found in the battery case.



<sup>6</sup> cabriolet only.

<sup>7</sup> coupé only.

**!** The remote control has an operating range of approximately 50 ft (15 meters). This can fluctuate greatly as a consequence of local conditions (reflective or absorbing objects) and interference emitted by other radio transmission systems. Similarly, the operating range fluctuates in line with the direction from which the remote control is activated.

To prevent theft, however, it is advisable to only unlock the vehicle when you are in close proximity to it.

### Locking and unlocking from the outside

- ▶ **Selective unlocking:** Press button  on the key once.  
All turn signal lamps flash once.  
The anti-theft warning system\* is disarmed.  
The driver's door and the fuel filler flap are unlocked.
  - ▶ **Global unlocking:** Press button  on the key twice.  
All turn signal lamps flash once again.  
The passenger door and the tailgate are unlocked in addition to the driver's door and the fuel filler flap.
  - ▶ **Global locking:** Press button  on the key.  
With the doors, the tailgate(s), and the fuel filler flap closed, the turn signal lamps flash three times.  
The anti-theft warning system\* is armed.  
The indicator lamp on the central locking switch flashes (> page 54).  
The interior and exterior<sup>8</sup> lamps come on and then go out again after 12 seconds.
- i** In vehicles with anti-theft warning system\*, an acoustic signal will sound when locking or unlocking the vehicle.

<sup>8</sup> Vehicles with rain-light sensor\* only.

\* optional

When unlocking, the acoustic signal sounds once. When locking, the acoustic signal sounds three times.

The acoustic signal is activated at the factory. If you wish to deactivate the feature, contact an authorized smart center.

### Automatic locking



#### Auto-relock function

The vehicle will lock again automatically within approximately 60 seconds of unlocking with the key if neither the driver's nor passenger door is opened.

- !** To prevent an inadvertent lockout, never leave your key lying in the vehicle.

#### Drive lock function

The vehicle locks automatically when the ignition is switched on and the wheels are turning at vehicle speeds of approximately 8 mph (14 km/h) or more. The drive lock function is enabled at the factory.

- ▶ **Switching on:** Switch off the ignition.
- ▶ Press the central locking switch (> page 54) and button  on the key simultaneously.  
An acoustic signal sounds.  
The drive lock function is switched on.
- ▶ **Switching off:** Switch off the ignition.
- ▶ Press the central unlocking switch (> page 54) and button  on the key simultaneously.  
An acoustic signal sounds.  
The drive lock function is switched off.

### Locking and unlocking from the inside

#### ⚠ WARNING

When leaving the vehicle, always remove the key from the starter switch, take it with you, and lock the vehicle. Do not leave children unattended in the vehicle, or with access to an unlocked vehicle. A child's unsupervised access to a vehicle could result in an accident and/or serious personal injury.

You can lock and unlock the vehicle from inside using the central locking or unlocking switch. This can be useful, for example, if you want to unlock the passenger door from inside or lock the vehicle before starting to drive.

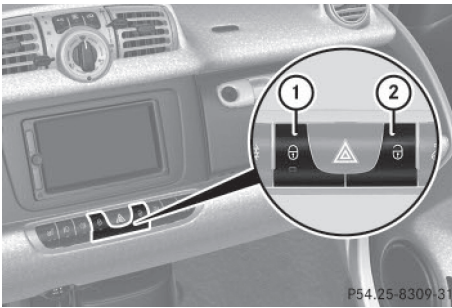

- **Locking:** Press central locking switch ①.

The indicator lamp on central locking switch ① comes on, when the starter switch is in position 1.

The indicator lamp on central locking switch ① flashes, when the starter switch is in position 0.

With the doors and the tailgate closed, the vehicle locks.

- **Unlocking:** Press central unlocking switch ②.

The vehicle unlocks and the indicator lamp on central locking switch ① goes out.

### Opening the doors from the inside

You can open a locked door from the inside. Open door only when conditions are safe to do so.



- Pull on inside door handle ①.  
With the driver's door open a warning signal sounds if the exterior lamps are switched on and the ignition is switched off.



### Opening the upper tailgate on the coupé

#### ⚠ WARNING

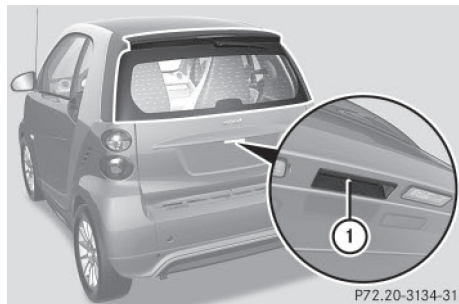
Make sure the tailgate is closed when the engine is running and while driving. Among other dangers, deadly carbon monoxide (CO) gases may enter vehicle interior resulting in unconsciousness and death.





- ▶ Press button  on the key twice.
- ▶ Press and hold button  on the key for approximately two seconds.

or

- ▶ Pull the release handle in handle recess  of the lower tailgate. The upper tailgate is unlocked.
- ▶ Swivel the upper tailgate upwards to open.

Observe the information on loading the vehicle (▷ page 112).

For information on vehicle weights, see "Vehicle specification" (▷ page 215).

### Opening the lower tailgate on the coupé

#### **WARNING**

High outside temperature, stop-and-go traffic, driving on long uphill grades, or driving at high engine speed may increase the temperature in the engine compartment. Therefore the area around the air slots in the rear apron may be hot. Let the engine cool off before touching this area to prevent burns.

- ▶ Open the upper tailgate (▷ page 54).



P72.20-3135-31

- ▶ Pull either of the release levers  backwards. The lower tailgate is unlocked.
- ▶ Swivel the lower tailgate downwards to open. The lower tailgate is held in the horizontal position by means of the two retaining straps.

**!** When folded down, the lower tailgate can bear loads up to maximum of 220 lbs (100 kg).

Observe the information on loading the vehicle (▷ page 112).

For information on vehicle weights, see "Vehicle specification" (▷ page 215).

### Closing the tailgate(s) on the coupé

#### **WARNING**

To prevent possible personal injury, always keep hands and fingers away from the cargo compartment opening when closing the tailgate(s). Be especially careful when small children are around.



P72.20-3136-31

- ▶ Swivel the lower tailgate upwards to close. Allow the two release levers to engage audibly.
- ▶ Swivel the upper tailgate downwards to close.

#### **WARNING**

When leaving the vehicle, always remove the key from the starter switch, take it with

you, and lock the vehicle. Do not leave children unattended in the vehicle, or with access to an unlocked vehicle. A child's unsupervised access to a vehicle could result in an accident and/or serious personal injury.

### Opening and closing the retractable soft top (cabriolet only)

You can fully open the retractable soft top with the key.

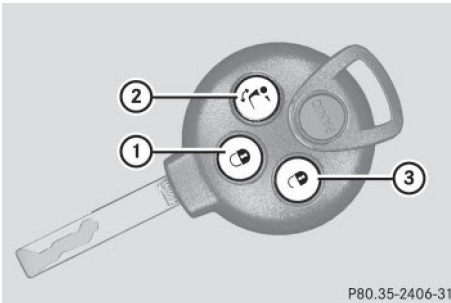

P80.35-2406-31

Key with remote control

- ① Lock button
- ② Opening the retractable soft top
- ③ Unlock button

► **Opening:** Press button ② on the key for approximately two seconds. The retractable soft top opens.

ⓘ Pressing symbols ③, ① or ② on the key with remote control while opening the retractable soft top will interrupt the opening procedure.

► **Closing:** Press symbol  on the retractable soft top switch (▷ page 56).

#### WARNING

When closing the retractable soft top, make sure there is no danger of anyone being harmed by the closing procedure.

ⓘ The remote control has an operating range of approximately 50 ft (15 meters).

Take care that you do not open your vehicle's retractable soft top inadvertently.

### Opening the tailgate on the cabriolet

#### WARNING

Make sure the tailgate is closed when the engine is running and while driving. Among other dangers, deadly carbon monoxide (CO) gases may enter vehicle interior resulting in unconsciousness and death.

#### WARNING

High outside temperature, stop-and-go traffic, driving on long uphill grades, or driving at high engine speed may increase the temperature in the engine compartment. Therefore the area around the air slots in the rear apron may be hot. Let the engine cool off before touching this area to prevent burns.

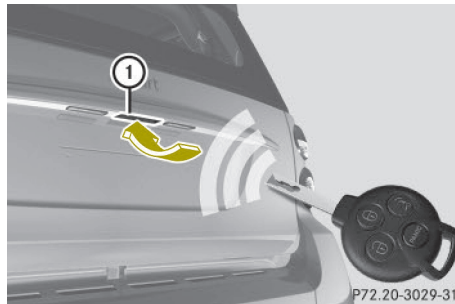

P72.20-3029-31

- Press button ① on the key twice.
- Pull the release handle in handle recess ① of the tailgate. The tailgate is unlocked.
- Swivel the tailgate downwards to open.

### Opening and closing the rear soft top (cabriolet only)

You can open the rear soft top to ease loading and unloading.

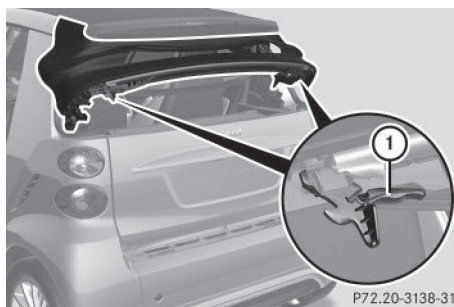

- ▶ **Opening:** Push release levers ①, located to the left and right of the retaining clip, upwards.
- ▶ Swivel the rear soft top upwards to open.

**⚠ WARNING**

To prevent possible personal injury, always keep hands and fingers away from the cargo compartment opening when closing the rear soft top. Be especially careful when small children are around.

- ▶ **Closing:** Swivel the rear soft top downwards to close.
- ▶ Pull soft top down.
- ▶ Pull release levers ①, located to the left and right of the retaining clip, downwards.
- ▶ Make sure the rear soft top is correctly locked in place on both sides.

**Closing the tailgate on the cabriolet**

**⚠ WARNING**

To prevent possible personal injury, always keep hands and fingers away from the cargo compartment opening when closing the tailgate. Be especially careful when small children are around.

- ❗ When closing the tailgate, you must first close the rear soft top. Otherwise you might break the release levers of the rear soft top.

- ▶ Swivel the tailgate upwards to close. Let the tailgate lock into place.

**⚠ WARNING**

When leaving the vehicle, always remove the key from the starter switch, take it with you, and lock the vehicle. Do not leave children unattended in the vehicle, or with access to an unlocked vehicle. A child's unsupervised access to a vehicle could result in an accident and/or serious personal injury.

**Starter switch positions**

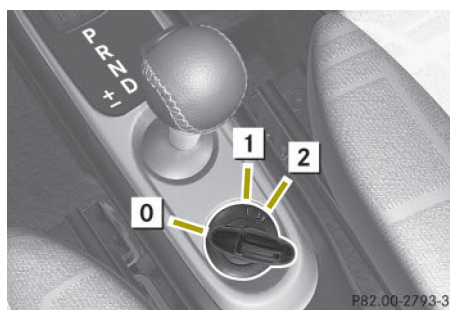

Starter switch

0	For removing key
1	Ignition (power supply for all electrical consumers) and driving position  All lamps (except low-beam headlamp indicator lamp, high-beam headlamp indicator lamp, and turn signal indicator lamps unless activated) in the instrument cluster come on. If a lamp in the instrument cluster fails to come on when the ignition is switched on, have it checked and replaced if necessary. If a lamp in the instrument cluster remains on after starting the engine or comes on while driving, refer to "Warning and indicator lamps in the instrument cluster" (> page 162).
2	Starting (> page 77)

- i** When you switch on the ignition, the indicator and warning lamps (except low-beam headlamp indicator lamp, high-beam headlamp indicator lamp, and turn signal indicator lamps unless activated) in the instrument cluster come on. The indicator and warning lamps (except low-beam headlamp indicator lamp, high-beam headlamp indicator lamp, and turn signal indicator lamps if activated) will go out when the engine is running. This indicates that the respective systems are operational.

## Seats

### Safety notes

#### WARNING

All seat adjustments, as well as fastening of seat belts, must be done before the vehicle is operated.

#### WARNING

When adjusting the seat, make sure no one becomes trapped.

Do not adjust the driver's seat while driving. Adjusting the seat while driving could cause the driver to lose control of the vehicle.

Never ride in a moving vehicle with the seat backrest in an excessively reclined position as this can be dangerous. You could slide under the seat belt in a collision. If you slide under the seat belt, it could apply force at the abdomen or neck, potentially causing serious or fatal injuries. The seat backrest and seat belts provide the best restraint when the wearer is in a position that is as upright as possible and seat belts are properly positioned on the body.

Your seat must be adjusted so that you can correctly fasten your seat belt.

Observe the following points:

- Adjust the seat backrest until your arms are slightly angled when holding the steering wheel.
- Adjust the seat to a comfortable seating position that still allows you to reach the accelerator/brake pedal safely. The position should be as far back as possible with the driver still able to operate the controls properly.
- Never place hands under the seat or near any moving parts while a seat is being adjusted.

Failure to do so could result in an accident and/or serious personal injury.

Observe the notes on the air bag system.

#### WARNING

Children 12 years old and under must be seated and properly secured in an appropriately sized infant restraint, toddler restraint, or booster seat recommended for the size and weight of the child. For additional information, see "Children in the vehicle".

A child's risk of serious or fatal injuries is significantly increased if the child restraints are not properly secured in the vehicle and/or the child is not properly secured in the child restraint.

#### **WARNING**

Contact an authorized smart center if the seats have become damaged.

The seat is an integral part of the vehicle's safety system in the same way as seat belts and air bags. Damage to the seats may reduce their ability to protect the occupants in an accident.

### Seat adjustment

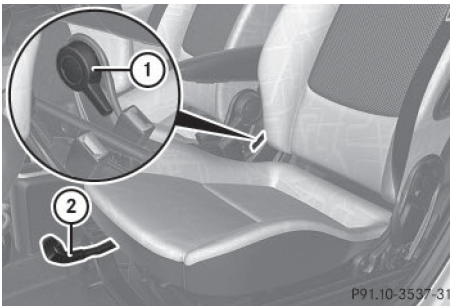

- ① Seat backrest tilt
- ② Seat fore and aft adjustment

### Seat backrest tilt

- ▶ **Adjusting:** Sit down on the front seat.
- ▶ Pull adjustment lever ① upwards and adjust the seat backrest until your arms are slightly angled when holding the steering wheel.
- ▶ Release adjustment lever ① when the desired seat backrest tilt is reached. When you hear an audible click, the seat backrest is again fixed into place.
- ▶ Check for proper engagement before driving.

\* optional

- ▶ **i** When adjusting the tilt of the backrest without any load on the seat then hold on to the backrest with one hand.

### Seat fore and aft adjustment

- ▶ Pull adjustment handle ② upwards and slide the seat to a seating position that still allows you to reach the accelerator/brake pedal safely.
- ▶ Release adjustment handle ② when the desired seating position is reached. When you hear an audible click, the seat is again fixed into place.
- ▶ Check for proper engagement before driving.

### Seat height

The seat guide is inclined in the horizontal plane. Seat fore and aft adjustment also alters the seat height.

### Armrest\* on driver's seat

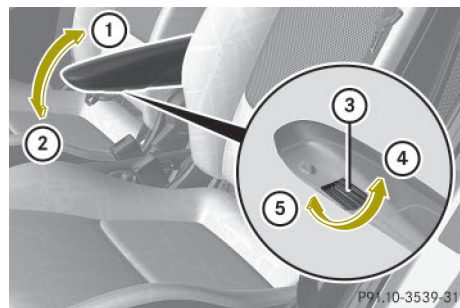

### Folding up and down

- ▶ **Folding up:** Hold front of armrest and fold it up in direction of arrow ①.
- ▶ **Folding down:** Hold front of armrest and fold it down in direction of arrow ②.

### Adjusting armrest angle

You can adjust the angle of the armrest when it is folded down.

- ▶ Turn thumb wheel ③.

- Direction of arrow ④: down
- Direction of arrow ⑤: up

### Passenger seat

You can expand the cargo compartment by folding down the passenger seat. Observe the loading instructions (▷ page 112).

#### Folding down

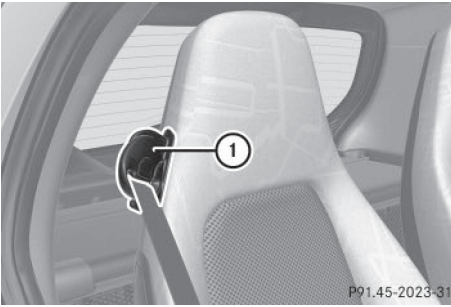

- ▶ Remove the seat belt from seat belt guide ①.
- ▶ Move the passenger seat backward as far as it will go.

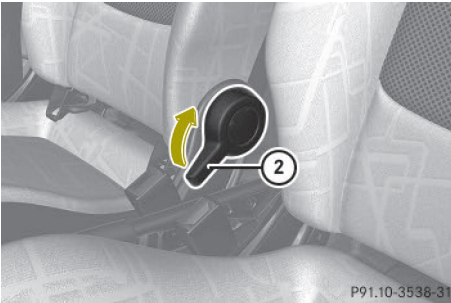

- ▶ Hold the backrest with one hand back.
- ▶ Pull adjustment lever ② upwards and unlock the seat backrest.
- ▶ Fold the seat backrest forward.

#### Folding back

- ▶ Pull adjustment lever ② upwards and unlock the seat backrest.
- ▶ Fold the seat backrest backward. When you hear an audible click, the seat backrest is again fixed into place.
- ▶ Check for proper engagement before driving.
- ▶ Place the seat belt back in seat belt guide ①.

#### ⚠ WARNING

When folding the passenger seat backrest back to its upright position, please make sure

- nobody becomes trapped
- no obstacles are jammed in the lock
- the adjustment lever has audibly locked into position

A properly engaged passenger seat backrest will help to prevent stored objects in the cargo compartment from being thrown about and injuring vehicle occupants during

- braking
- vehicle maneuvers
- an accident

#### Seat heating\*

The seat heating allows you to heat the driver's and passenger seat electrically.

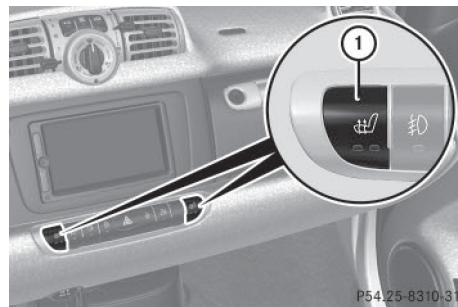

The seat heating has two levels.

\* optional

The indicator lamps on seat heating switch ① come on to show which heating level you have selected.

Level	Indicator lamps on the switch
off	No indicator lamp on
1	One indicator lamp on
2	Two indicator lamps on

- ▶ Make sure the key is in starter switch position 1.
- ▶ **Switching on:** Press seat heating switch ① repeatedly until the desired seat heating level is reached.
- ▶ **Switching off:** Press seat heating switch ① repeatedly until all indicator lamps go out.

**!** If the seat heating is malfunctioning, the indicator lamp(s) on the switch come(s) on briefly when you press the switch and then go(es) out again. Contact an authorized smart center.

## Mirrors

Adjust the interior and exterior rear view mirrors before driving so that you have a good view of the road and traffic conditions.

### Exterior rear view mirrors

#### WARNING

Exercise care when using the passenger-side exterior rear view mirror. The mirror surface is convex (outwardly curved surface for a wider field of view). Objects in mirror are closer than they appear. Check your interior rear view mirror and glance over your shoulder to determine whether any vehicles are in the 'blind spot' of your field of vision, before changing lanes.

### Manually adjustable exterior rear view mirrors

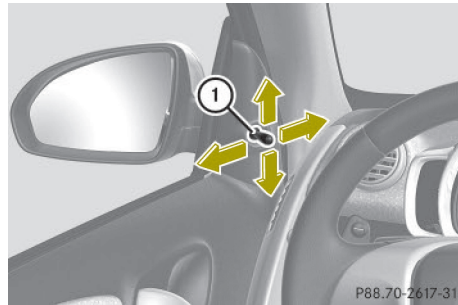

- ▶ **Adjusting:** Move adjustment lever ① up, down, left, or right to the desired setting.

### Power exterior rear view mirrors

This feature is only available on the model passion and BRABUS.

The operating control is on the door control panel.

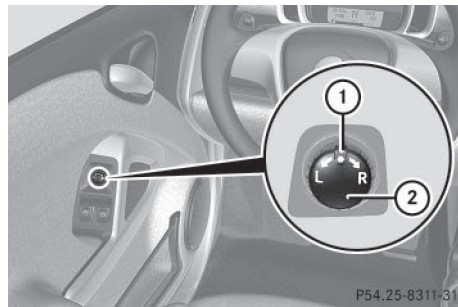

- ▶ Make sure the key is in starter switch position 1.
- ▶ **Selecting the mirror:** Turn knob ① to the left for the driver's side exterior rear view mirror or to the right for the passenger side exterior rear view mirror.
- ▶ **Adjusting the mirror:** Move adjustment button ② up, down, left, or right to the desired setting.

### Exterior rear view mirror heating

This feature is only available on the model passion and BRABUS and in conjunction with power exterior rear view mirrors.

After switching on the rear window defroster, the exterior rear view mirrors will be heated automatically. This prevents icing up the exterior rear view mirrors and also creates a clear view when the exterior rear view mirrors have fogged up.

If the rear window defroster is automatically deactivated after approximately 10 minutes of operation, the exterior rear view mirror heating also deactivates.

- ▶ Make sure the key is in starter switch position **1**.
- ▶ **Switching on:** Switch on the rear window defroster (▷ page 106).  
The exterior rear view mirror heating is switched on.
- ▶ **Switching off:** Switch off the rear window defroster (▷ page 106).  
The exterior rear view mirror heating is switched off.

- ⓘ The exterior rear view mirror heating also switches off if the key is turned to starter switch position **0**.

### Interior rear view mirror

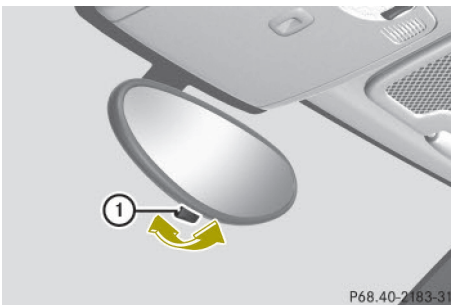

- ▶ **Adjusting the mirror:** Manually move the interior rear view mirror up, down, left, or right to the desired setting.
- ▶ **Selecting the antiglare position:** Tilt the interior rear view mirror to the antiglare position by moving lever ① forward or backward.

## Seat belts

### Fastening the seat belts

#### ⚠ WARNING

Always fasten your seat belt before driving. Always make sure all of your passengers are properly restrained.

Failure to wear and properly fasten and position your seat belt greatly increases your risk of injuries and their likely severity in an accident. You and your passenger should always wear seat belts.

If you are ever in an accident, your injuries can be considerably more severe without your seat belt properly buckled.

Without your seat belt buckled, you are much more likely to hit the interior of the vehicle or be ejected from it. You can be seriously injured or killed.

In the same crash, the possibility of injury or death is lessened if you are properly wearing your seat belt. Air bags can only protect you if you are properly wearing your seat belt.

#### ⚠ WARNING

Children 12 years old and under must be seated and properly secured in an appropriately sized infant restraint, toddler restraint, or booster seat recommended for the size and weight of the child. For additional information, see "Children in the vehicle".

A child's risk of serious or fatal injuries is significantly increased if the child restraints are not properly secured in the



vehicle and/or the child is not properly secured in the child restraint.

**⚠ WARNING**

Never let more people ride in the vehicle than there are seat belts available. Make sure everyone riding in the vehicle is correctly restrained with a separate seat belt. Never use a seat belt for more than one person at a time.

**⚠ WARNING**

Never ride in a moving vehicle with the seat backrest in an excessively reclined position as this can be dangerous. You could slide under the seat belt in a collision. If you slide under it, the belt would apply force at the abdomen or neck, causing serious or even fatal injuries. The seat backrest and seat belt provide the best restraint when the wearer is in a position that is as upright as possible and the belt is properly positioned on the body.

**⚠ WARNING**

Observe "Safety notes" (▷ page 35).

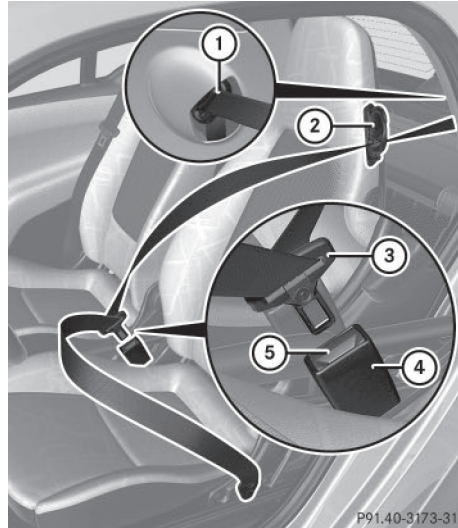

- ① Seat belt outlet
- ② Seat belt guide
- ③ Latch plate
- ④ Seat belt buckle
- ⑤ Release button

- ▶ **Fastening the seat belt:** With a smooth motion, pull the seat belt out of seat belt outlet ①.
- ▶ Place the shoulder portion of the seat belt across the top of your shoulder and the lap portion across your hips.
- ▶ Push latch plate ③ into seat belt buckle ④ until it clicks.
- ▶ If necessary, tighten the lap portion of the seat belt to a snug fit by pulling shoulder portion up.
- ▶ **Unfastening the seat belt:** Press release button ⑤.
- ▶ Allow the retractor to completely rewind the seat belt by guiding latch plate ③.

#### Proper use of seat belts

- Do not twist the seat belt when fastening.
- Adjust the seat belt so that the shoulder portion is located as close as possible to the middle of the shoulder (it should not

touch the neck). Never pass the shoulder portion of the seat belt under your arm.

- Position the lap belt as low as possible on your hips (over hip joint) and not across the abdomen.
- Place the seat backrest in a position that is as upright as possible.
- Never use a seat belt for more than one person at a time.
- Do not fasten a seat belt around a person and another object at the same time. When using a seat belt to secure infant or toddler restraints or children in booster seats, always follow the child seat manufacturer's instructions.
- Check your seat belt during travel to make sure it is properly positioned.
- Make sure the seat belt is always fitted snugly. Take special care to maintain a snug fit when wearing loose clothing.

#### WARNING

Do not pass seat belts over sharp edges. They could tear.

Do not allow the seat belt to get caught in the door or in the seat adjustment mechanism. This could damage the seat belt.

Never attempt to make modifications to seat belts. This could impair the effectiveness of the seat belts.

Do not bleach or dye seat belts as this may severely weaken them. In a crash they may not be able to provide adequate protection. Damaged seat belts or seat belts that were highly stressed in an accident must be replaced. Contact an authorized smart center.

#### Correct driver seat adjustment

#### WARNING

Observe "Safety notes" (> page 58).



- ▶ Adjust the driver's seat properly (> page 59).

Make sure that you

- are positioned as far away from the driver's front air bag as possible
  - can reach steering wheel ① with your arms slightly bent at the elbows
  - can fasten seat belt ② properly
  - you have adjusted seat backrest ③ to a position that is as upright as possible
  - you can move your legs freely
  - you can depress the brake and accelerator pedal safely.
- ▶ Make sure the seat belt is fastened properly (> page 62).

## Lighting

### Exterior lamp switch

For safety, smart recommends that you drive with your low-beam headlamps on during the day. In certain countries, local laws dictate that low-beam headlamps are switched on automatically during operation of the vehicle.

- i** If you drive in countries where vehicles drive on the other side of the road than the country in which the vehicle is registered, you must have the headlamps modified for symmetrical low beams. Relevant information can be obtained at any authorized smart center.

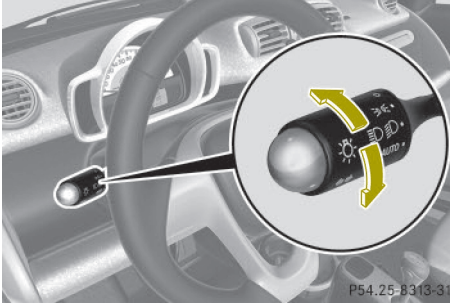

Exterior lamp switch

- Lamps off  
Daytime running lamp mode\*
- Parking lamps
- Low-beam headlamps or high-beam headlamps
- AUTO** Automatic headlamp mode\*

### Parking lamps

You can switch on and off the parking lamps with the exterior lamp switch using the manual headlamp mode.

- **Switching on:** Turn the exterior lamp switch to position . The parking lamps come on. The following lamps also come on:
- Tail lamps
  - License plate lamps
  - Side marker lamps

### Low-beam headlamps

You can switch on and off the low-beam headlamps with the exterior lamp switch using the manual headlamp mode.

- **Switching on:** Turn the exterior lamp switch to position . The low-beam headlamps come on. The low-beam headlamp indicator lamp  in the instrument cluster comes on. The following lamps also come on:
- Tail and parking lamps
  - License plate lamps
  - Side marker lamps

### Automatic headlamp mode\*

This feature is only available on vehicles with rain-light sensor\*.

The following lamps come on and go out automatically depending on the brightness of the ambient light:

- Low-beam headlamps
- Tail and parking lamps
- License plate lamps
- Side marker lamps

#### **WARNING**

If the exterior lamp switch is set to position **AUTO**, the headlamps will not be automatically switched on under foggy conditions.

To minimize risk to you and to others, activate headlamps by turning exterior lamp switch to position  when driving or when traffic and/or ambient lighting conditions require you to do so.

In low ambient lighting conditions, only switch from position **AUTO** to  with the vehicle at a standstill in a safe location. Switching from position **AUTO** to  will briefly switch off the headlamps. Doing so while driving in low ambient lighting conditions may result in an accident.

The automatic headlamp feature is only an aid to the driver. The driver is responsible for the operation of the vehicle's lights at all times.

\* optional

- ▶ Turn the exterior lamp switch to position **AUTO**.

With the key in starter switch position **1**, the tail and parking lamps, the license plate lamps, and the side marker lamps will come on and go out automatically depending on the brightness of the ambient light.

With the engine running, the low-beam headlamps, the tail and parking lamps, the license plate lamps and the side marker lamps will come on and go out automatically depending on the brightness of the ambient light.

#### Daytime running lamp mode\*

In USA, the daytime running lamp mode can be deactivated.



In Canada, the daytime running lamp mode is mandatory and therefore in a constant mode.

Depending on the vehicle equipment, your vehicle comes either with low-beam daytime running lamps or with LED daytime running lamps.



#### Switching on:

- ▶ Start the engine.  
The daytime running lamps are switched on.  
On vehicles with low beam daytime running lamps the parking lamps also come on.

#### Switching off - vehicles without rain-light sensor\*:

- ▶ Switch on the parking lamps  or the low-beam headlamps .  
The daytime running lamps are switched off.

#### Switching off - vehicles with rain-light sensor\*:

- ▶ Switch on the parking lamps  or the low-beam headlamps .  
The daytime running lamps are switched off.

or

- ▶ Turn the exterior lamp switch to position **AUTO**.

With the engine running, the low-beam headlamps, the tail and parking lamps, the license plate lamps and the side marker lamps will come on and go out automatically depending on the brightness of the ambient light.

#### Deactivating (USA only):

- ▶ Switch off the ignition.
- ▶ Remove the key from the starter switch.
- ▶ Switch on the high-beam flasher and press button  on the key simultaneously.  
An acoustic signal sounds.  
The daytime running lamp mode is deactivated.

#### Reactivating (USA only):



- ▶ Switch off the ignition.
- ▶ Remove the key from the starter switch.
- ▶ Switch on the high-beam flasher and press button  on the key simultaneously.  
An acoustic signal sounds.  
The daytime running lamp mode is reactivated.

#### Combination switch (high beam, high beam flasher and turn signals)

- ▶ Make sure the key is in starter switch position **1**.

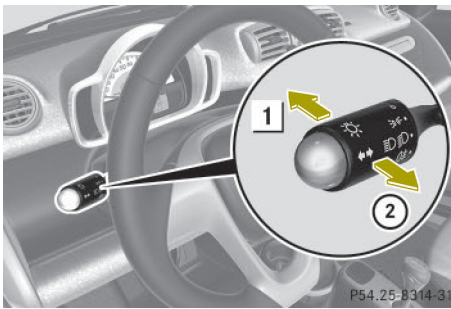
### High-beam headlamps and high-beam flasher



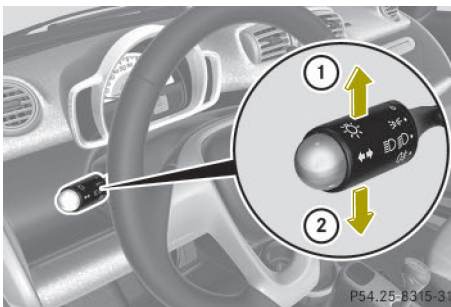

- ▶ Make sure the low-beam headlamps are switched on (▷ page 65).
- ▶ **Switching on:** Push the combination switch to position 1. The high-beam headlamps come on. The high-beam headlamp indicator lamp  in the instrument cluster comes on.
- ▶ **Switching off:** Pull the combination switch in direction of arrow 2 to its original position. The high-beam headlamps go out. The high-beam headlamp indicator lamp  in the instrument cluster goes out.
- ▶ **High-beam flasher:** Pull the combination switch briefly in direction of arrow 2.

### Turn signals



- ① Turn signals, right
- ② Turn signals, left

- ▶ **Switching on:** Push the combination switch in direction of arrow ① or ②. The corresponding turn signals flash. The corresponding turn signal indicator lamp  or  in the instrument cluster flashes. The combination switch resets automatically after major steering wheel movement.

- ⓘ To signal minor directional changes such as changing lanes, push the combination switch only to the point of resistance and release. The corresponding turn signals will flash three times.

### Coming home function

**Vehicles without rain-light sensor:** The interior lamps come on and then go out again after 12 seconds every time when you lock or unlock the vehicle.

**Vehicles with rain-light sensor\*:** In addition to the interior lamps, the exterior lamps come on and then go out again after 12 seconds depending on the brightness of the ambient light when you lock or unlock the vehicle.

### When leaving the vehicle

- ▶ Remove the key from the starter switch.
- ▶ Exit the vehicle.
- ▶ Press button  on the key. The vehicle is locked. The interior and exterior<sup>9</sup> lamps come on and then go out again after 12 seconds.

### When returning to the vehicle

- ▶ Press button  on the key either once or twice. The vehicle is either selectively or globally unlocked.

<sup>9</sup> Vehicles with rain-light sensor\*.

\* optional

The interior and exterior<sup>9</sup> lamps come on and then go out again after 12 seconds.

### Ambient lighting\*

The ambient lighting illuminates the vehicle interior with 6 LEDs when the low-beam headlamps are switched on. The LEDs can be dimmed.

The LEDs are located

- in the overhead control panel
- in the door pockets, driver's and passenger side
- in the storage trays to the left and right of the steering wheel

In addition to the ambient lighting, the footwells on the driver's and passenger side are also illuminated by separate lamps.

- ❗ When you open a door, the interior lighting comes on and the brightness of lamps in the footwells increases.

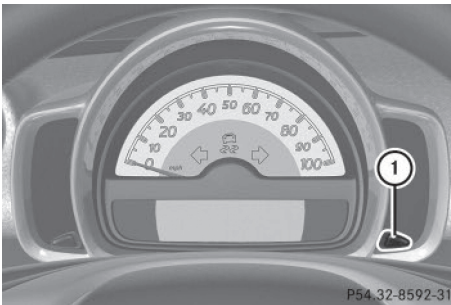

- ▶ Make sure the key is in starter switch position 1.
- ▶ Switch on the parking lamps.
- ▶ **To brighten or dim ambient lighting:** Press button ① on the instrument cluster repeatedly until the desired setting is reached. The current setting is stored.



<sup>9</sup> Vehicles with rain-light sensor\*.

- ❗ When adjusting the ambient lighting, the illumination level for instrument cluster is also changed (▷ page 92).

### Front fog lamps

#### ⚠ WARNING

Vehicles with rain-light sensor\*:

In low ambient lighting or foggy conditions, only switch from position **AUTO** to  with the vehicle at a standstill in a safe location. Switching from **AUTO** to  will briefly switch off the headlamps. Doing so while driving in low ambient lighting conditions may result in an accident.

- ❗ Fog lamps will operate with the parking lamps and/or the low-beam headlamps on. Fog lamps should only be used in conjunction with low-beam headlamps. Consult your State or Province Motor Vehicle Regulations regarding permissible lamp operation.

- ❗ Vehicle with rain-light sensor\*: Fog lamps cannot be switched on manually with the exterior lamp switch in position **AUTO**. To switch on the fog lamps, turn the exterior lamp switch to position  first.

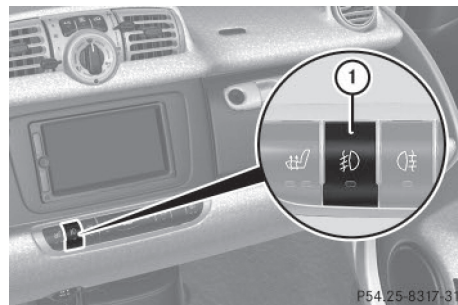

\* optional

- ▶ Make sure the parking lamps or the low-beam headlamps are switched on.
- ▶ **Switching on:** Press switch ①. The front fog lamps come on. The indicator lamp in the switch comes on.
- ▶ **Switching off:** Press switch ① once more. The front fog lamps go out. The indicator lamp in the switch goes out.

### Hazard warning flasher

The hazard warning flasher can be switched on at all times, even with the key removed from the starter switch.

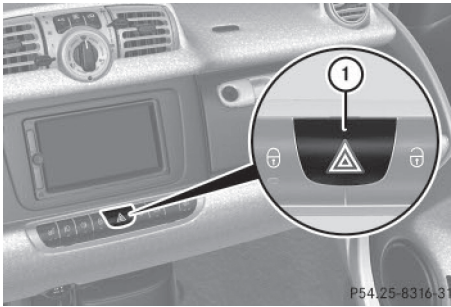

- ▶ **Switching on:** Press hazard warning flasher switch ①. All turn signal lamps are flashing.
- ▶ **Switching off:** Press hazard warning flasher switch ① once more.

### Interior lighting

The interior lamp comes on for a period of time when you open the doors, or lock or unlock the vehicle with the key.

It goes out

- immediately after switching off the ignition with all doors closed
- after 30 seconds if the doors are not opened

- after 15 seconds if all doors are closed
- after 10 minutes if at least one door is open

The rocker switch can be set to three different positions.

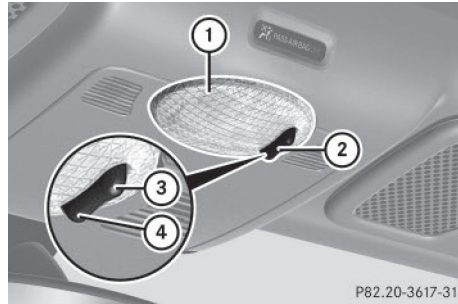

- ① Interior lamp
- ② Off
- ③ Switching on the automatic control
- ④ Continuous operation

### Automatic control

- ▶ Set the rocker switch to position ③. The interior lamp comes on for a period of time.

### Switching off

- ▶ Set the rocker switch to position ②. The interior lamp is permanently switched off.

### Continuous operation

- ▶ Set the rocker switch to position ④. The interior lamp is permanently switched on.

**!** When leaving the vehicle, make sure the interior lamp is not set to continuous operation and none of the doors is left open for a long period of time.

Doing otherwise could result in a discharged battery.

## Windshield wipers

## Switching windshield wipers on and off

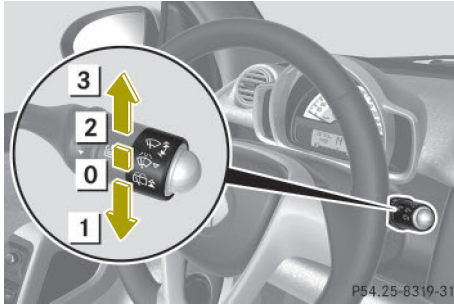

Example illustration coupé

- ▶ Make sure the key is in starter switch position **1**.
- ▶ **Switching on:** Turn the wiper switch to position **2** or **3**, depending on the intensity of the rain.
- ❗ Do not operate the windshield wipers when the windshield is dry. Dust that accumulates on a windshield might scratch the glass and/or damage the wiper blades when wiping occurs on a dry windshield. If it is necessary to operate the windshield wipers in dry weather conditions, always operate the windshield wipers with windshield washer fluid.
- ❗ If anything blocks the windshield wipers (leaves, snow, etc.), switch them off immediately.  
For safety reasons, stop the vehicle in a safe location and
  - - remove the key from the starter switch
  - engage the parking brake before attempting to remove any blockage.
  - Remove blockage.
  - Turn the windshield wipers on again.
- ▶ **Switching off:** Turn the wiper switch to position **0**.

## Intermittent wiping

Only switch on intermittent wiping under wet weather conditions or in the presence of precipitation.

Vehicles with rain-light sensor\*: When you select intermittent wiping, the sensor is activated. The sensor automatically sets a suitable wiping interval depending on the wetness of the sensor surface.

## ❗ Vehicles with rain-light sensor\*:

Do not leave windshield wipers in intermittent setting when the vehicle is taken to an automatic car wash or during windshield cleaning. Windshield wipers will operate in the presence of water sprayed on the windshield, and windshield wipers may be damaged as a result.

## ❗ Vehicles with rain-light sensor\*:

If you have set intermittent wiping, dirt on the surface of the sensor or optical effects may cause the windshield wipers to wipe in an undesired fashion. This could then damage the windshield wiper blades or scratch the windshield. You should therefore switch off the windshield wipers when weather conditions are dry.

- ▶ Make sure the key is in starter switch position **1**.
- ▶ **Activating intermittent wiping:** Turn the wiper switch to position **1**.

After the initial wipe, pauses between wipes are automatically controlled depending on the vehicle speed and by the rain-light sensor\*.

- ▶ **Deactivating intermittent wiping:** Turn the wiper switch to position **0**.

\* optional

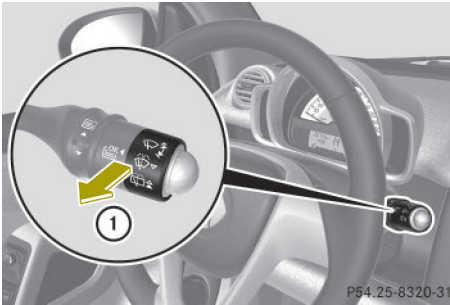

**Wiping with windshield washer fluid**

Example illustration coupé

- ▶ Pull the wiper switch in direction of arrow ① and hold it in position. The windshield wipers operate with windshield washer fluid.
  - ▶ Release the wiper switch. The windshield wipers will wipe three more times.
- i** To prevent smears on the windshield, or noisy/chattering wiper blades, wipe with windshield washer fluid periodically even when it is raining.

**Single wipe**

- ▶ Pull the wiper switch briefly in direction of arrow ①. The windshield wipers wipe one time with windshield washer fluid.

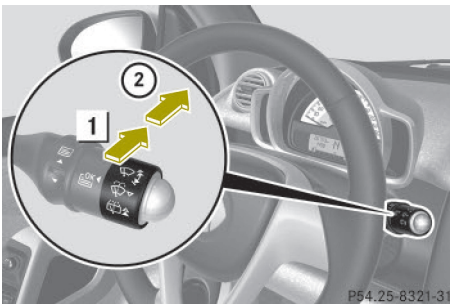
**Rear window wiper/washer (coupé only)**

- ▶ Make sure the key is in starter switch position 1.
- ▶ **Activating intermittent wiping:** Push the wiper switch to position ①.
- ▶ **Wiping with windshield washer fluid:** Push the wiper switch in direction of arrow ② and hold in position until the rear window is clean.
- ▶ Release the wiper switch. The rear window wiper will wipe three more times. Intermittent wiping is still activated.
- ▶ **Deactivating intermittent wiping:** Pull the wiper switch back to start position.

- i** The rear window wiper wipes one time when reverse gear **R** is engaged with the windshield wipers switched on.

**Soft top system (cabriolet only)****Introduction**

The soft top system of the smart cabriolet consists of a

- retractable soft top
- rear soft top
- side rails

You can remove the side rails over the doors when you open the retractable soft top and open the rear soft top.

- i** Opening the rear soft top is possible after the retractable soft top has been opened completely.

**Notes on the soft top system**

- !** When transporting long objects inside the vehicle, make sure they do not press against the retractable soft top when it is closed.

When carrying objects that protrude from the rear of the vehicle, make sure they are not resting on the retaining clips.

When loading, make sure no sharp objects come into contact with the soft top or the rear window.

Do not place any evenly distributed loads with a weight of more than 165 lbs (75 kg) on the rear soft top when folded down.

Make sure the high-mounted brake lamp is not concealed.

- ❗ Do not block the soft top system's locking apertures.

Only place the side rails in the designated storage space of the tailgate.

- ❗ Do not sit on the folded-down rear soft top.

Do not fold down the rear soft top at temperatures below 14°F (-10°C).

Do not place any pointed, sharp-edged, hot (above 176°F [80°C]), incandescent or burning objects on the soft top's lining.

Do not apply wax to the soft top fabric and select only wax-free washing products when using an automatic car wash.

Only drive with the retaining clips closed, as exhaust fumes could otherwise reach the vehicle's interior.

- ❗ Please keep in mind that weather conditions can sometimes change rapidly. Make sure to close the retractable soft top and the rear soft top when leaving the vehicle. If water enters the vehicle interior, vehicle electronics could be damaged which is not covered by the smart Limited Warranty.

### Opening and closing the retractable soft top

You can open and close the retractable soft top when the vehicle is either stationary or in motion.

#### WARNING

Never operate the retractable soft top if there is the possibility of anyone being

harmed by the opening or closing procedure.

#### WARNING

The retractable soft top is made out of fabric. In the event of an accident, the fabric may tear. This may result in an opening in the roof.

In a vehicle rollover, occupants not wearing their seat belts or not wearing them properly may be thrown out of the opening. Such an opening also presents a potential for injury for occupants wearing their seat belts properly as entire body parts or portions of them may protrude from the passenger compartment.

#### WARNING

When leaving the vehicle, always remove the key from the starter switch, take it with you, and lock the vehicle. Do not leave children unattended in the vehicle, or with access to an unlocked vehicle. A child's unsupervised access to a vehicle could result in an accident and/or serious personal injury.

- ❗ To avoid damaging the seals, do not transport any objects with sharp edges which can stick out of the retractable soft top.

Do not open the retractable soft top if there is snow or ice on the roof, as this could result in malfunctions.

If you cannot open or close the retractable soft top due to a malfunction contact Roadside Assistance or an authorized smart center.

- i To avoid draining the battery, leave the engine running when opening and closing the retractable soft top.

### Opening from outside

You can open the retractable soft top completely with the key.

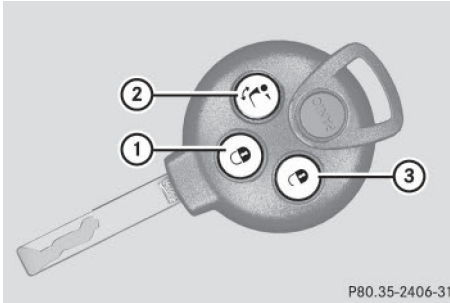

P80.35-2406-31

Key with remote control

- ① Lock button
- ② Opening the retractable soft top
- ③ Unlock button

- ▶ Press button on the key for approximately two seconds.  
The retractable soft top opens completely.

### Opening from the inside

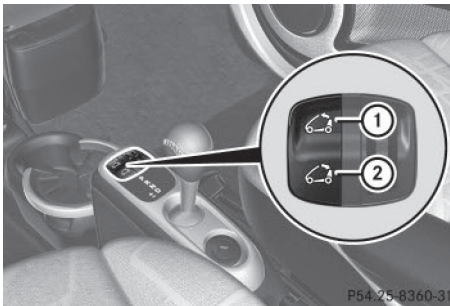

P64.25-8360-31

- ▶ Make sure the key is in starter switch position 1.
- ▶ Press symbol on the retractable soft top switch until the desired position is reached or the retractable soft top is opened completely.

or

- ▶ Press symbol on the retractable soft top switch briefly.  
The retractable soft top opens completely.

- i** Pressing symbol or on the retractable soft top switch while open-

ing the retractable soft top will interrupt the opening procedure.

### Closing

For safety reasons, you can only close the retractable soft top using the retractable soft top switch inside the vehicle.

- ▶ Make sure the key is in starter switch position 1.
- ▶ Press symbol on the retractable soft top switch until the retractable soft top is closed.

### Opening and closing the rear soft top

You can open and close the rear soft top when the vehicle is either stationary or in motion.

#### WARNING

Never operate the rear soft top if there is the possibility of anyone being harmed by the opening or closing procedure.

- !** Make sure objects are not stacked too high in the cargo compartment. They could get damaged when opening or closing the rear soft top.
- !** When the rear soft top is folded down, the side rails are accessible. To prevent theft, you should remove the side rails and store them in the storage compartment of the tailgate or close the soft top system.
- ▶ Make sure the key is in starter switch position 1.

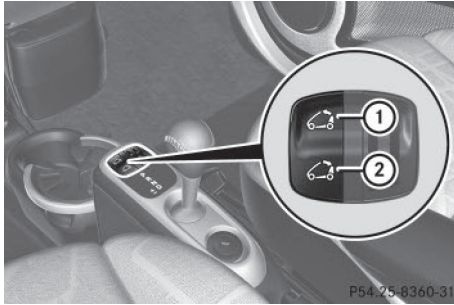

Retractable soft top switch

- ① Closing
- ② Opening

### Opening the rear soft top

- ▶ Press symbol ② on the retractable soft top switch or button ③ on the key until the retractable soft top has opened completely.
- ▶ Release retractable soft top switch ② or button ③ on the key.
- ▶ Press symbol ② on the retractable soft top switch once more until the rear soft top has folded down completely.

### Closing the rear soft top

- ▶ Press symbol ① on the retractable soft top switch until the rear soft top has folded up completely.
- ▶ Release retractable soft top switch ①.

**i** If you release the retractable soft top switch while driving before the rear soft top has closed completely, the rear soft top will fold down again.

### Removing the side rails

- ▶ Open the retractable soft top (▷ page 56).
- ▶ Open the rear soft top (▷ page 73).
- ▶ Open the driver's and passenger door when conditions are safe to do so.
- ▶ Open the tailgate (▷ page 56).



- ▶ Pull handle ① on the inside of the tailgate backward.
- ▶ Lift up the storage compartment cover.

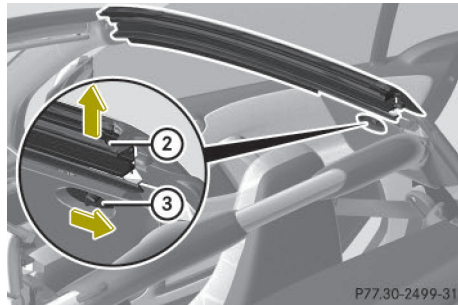

- ▶ Push release lever ③ of side rail ② backward. Side rail ② can be lifted at the rear end, but remains secured.
- ▶ Push release lever ③ backward again.

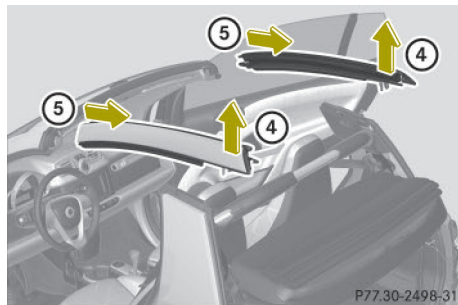

- ▶ Carry out the following steps when conditions are safe to do so.
- ▶ First lift the side rail at the rear end in direction of arrows ④.
- ▶ Then remove it in direction of arrows ⑤.

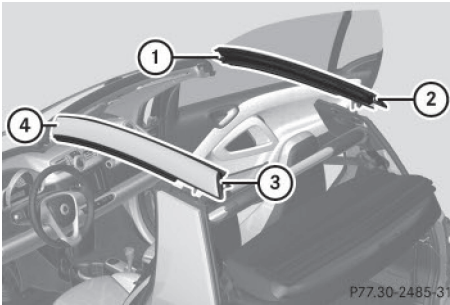
**Storing the side rails**

- ① Front right
- ② Rear right
- ③ Rear left
- ④ Front left

- ▶ Store the side rails in the storage compartment of the tailgate with the painted side facing down in the designated order ① to ④.

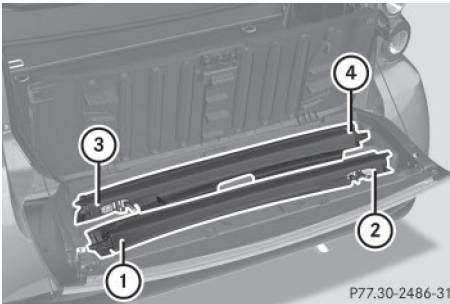

- ① Front right
- ② Rear right
- ③ Rear left
- ④ Front left

- ▶ Close the storage compartment cover.
- ▶ Press on the "PRESS" marking in the middle of the storage compartment cover until it engages audibly.

**⚠ WARNING**

Always close the storage compartment cover properly when storing the side rails. Otherwise occupants could be injured by the side rails moving about during

- braking
- vehicle maneuvers
- an accident

- ▶ Close the tailgate. Let the tailgate lock into place.
- ▶ Close the driver's and passenger door.
- ▶ Open the side windows if desired.

- ❗ Make sure the storage compartment cover is closed before closing the tailgate. Otherwise the tailgate could jam.

**Mounting the side rails**

- ▶ Open the driver's and passenger door when conditions are safe to do so.
- ▶ Open the tailgate.



- ▶ Pull handle ① on the inside of the tailgate backward.
- ▶ Lift up the storage compartment cover.
- ▶ Remove the side rails from the storage compartment in the tailgate.

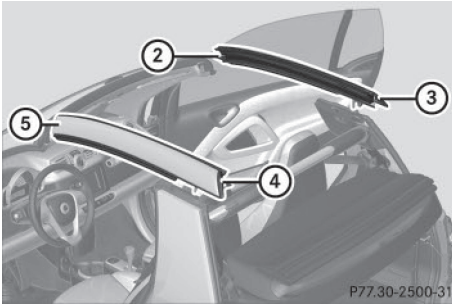

- ② Front right
- ③ Rear right
- ④ Rear left
- ⑤ Front left

- ▶ Install the side rails with the respective front end ② or ⑤ first.

#### **WARNING**

Make sure the side rails are properly mounted. Otherwise the side rails could disengage while driving and injure you and other persons.

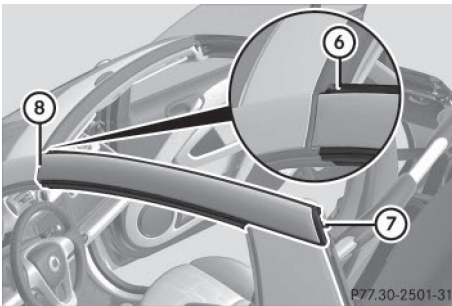

- ▶ Take one side rail and start by attaching it to front end ⑧.
- ▶ Make sure the seal of the side rail is facing up at position ⑥ and is not pinched.
- ▶ Push the side rail at rear end ⑦ downwards until it audibly engages into place twice.
- ▶ Install the side rail on the other side in the same manner.

- ❗ Make sure the side rails are installed correctly. Otherwise the side rails may not function properly or may be damaged.

- ▶ Close the storage compartment cover.
- ▶ Press on the "PRESS" marking in the middle of the storage compartment cover until it engages audibly.
- ▶ Close the tailgate. Let the tailgate lock into place.
- ▶ Close the driver's and passenger door.
- ▶ Open the side windows if desired.

- ❗ Make sure the storage compartment cover is closed before closing the tailgate. Otherwise the tailgate could jam.

## Side windows

### Opening and closing the side windows

#### Opening and closing the side windows manually

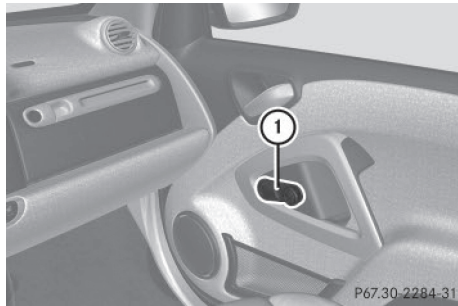

Crank for side window on passenger door

#### Side window on the driver's door

- ▶ **Opening:** Turn crank ① counterclockwise.
- ▶ **Closing:** Turn crank ① clockwise.

#### Side window on the passenger door

- ▶ **Opening:** Turn crank ① clockwise.
- ▶ **Closing:** Turn crank ① counterclockwise.

**Opening and closing the power windows**

This feature is only available on the model passion and BRABUS.

**⚠ WARNING**

Do not keep any part of your body up against the side window pane when opening a window. The downward motion of the pane may pull that part of your body down between the window pane and the door frame and trap it there. If there is a risk of entrapment, release the switch and pull up the top of the switch to close the window.

**⚠ WARNING**

When closing the windows, make sure there is no danger of anyone being harmed by the closing procedure.

The closing of the side windows can be immediately stopped by releasing the switch.

When leaving the vehicle, always remove the key from the starter switch, take it with you, and lock the vehicle. Do not leave children unattended in the vehicle, or with access to an unlocked vehicle. A child's unsupervised access to a vehicle could result in an accident and/or serious personal injury.

The switches for both power windows are on the driver's door. In addition, there is a switch for the passenger side on the passenger door.

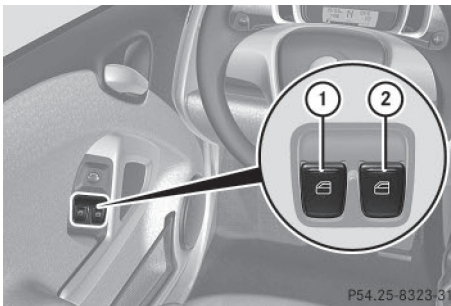

- ① Side window driver's door
- ② Side window passenger door

\* optional

- ▶ Make sure the key is in starter switch position **1**.
- ▶ **Opening:** Press and hold the top of the respective switch. The corresponding side window moves downwards until you release the switch.
- ▶ **Closing:** Pull and hold the top of the respective switch. The corresponding side window moves upwards until you release the switch.
- ▶ **Automatic opening:** Press the top of the respective switch briefly. The corresponding side window opens completely.
- ▶ **Stopping during automatic opening:** Press or pull the top of the respective switch again. The corresponding side window stops immediately.

**Driving and parking**

**Starting**

**⚠ WARNING**

Make sure absolutely no objects are obstructing the pedals' range of motion. Keep the driver's footwell clear of all obstacles. If there are any floor mats\* or carpets in the footwell, make sure the pedals still have sufficient clearance.

During sudden acceleration or braking maneuvers, the objects could get caught between or beneath the pedals and restrict your ability to brake or accelerate. This could lead to accidents and/or injury.

**⚠ WARNING**

Inhalation of exhaust gas is hazardous to your health. All exhaust gas contains carbon monoxide (CO), and inhaling it can cause unconsciousness and lead to death. Do not run the engine in confined areas (such as a garage) which are not properly ventilated. If you think that exhaust gas

fumes are entering the vehicle while driving, have the cause determined and corrected immediately. If you must drive under these conditions, drive only with at least one window fully open at all times.

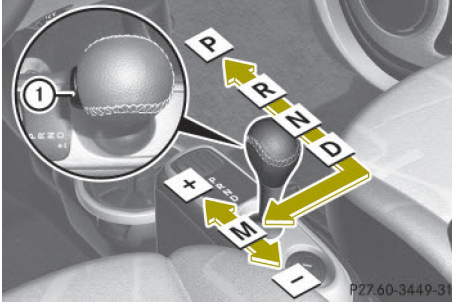

Gearshift pattern for transmission

① Release button

<b>P</b>	Park position
<b>R</b>	Reverse gear
<b>N</b>	Neutral position
<b>D</b>	Drive position
<b>M</b>	Manual gearshifting
<b>+</b>	Upshifting
<b>-</b>	Downshifting

### Starting the engine

**!** Shift the transmission into park position **P** or reverse gear **R** only when the vehicle is stopped in order to avoid damaging the transmission.

- ▶ Make sure the gear selector lever is set to park position **P**.  
The transmission position indicator should be on **P**.
- ▶ Do not depress the accelerator pedal.
- ▶ Turn the key to starter switch position **2** and release it.  
The engine starts automatically ("touch-start" function).

### Driving

- i** The vehicle has a crawler function. The vehicle moves forward when the brake pedal is released.
  - ▶ Depress the brake pedal.
  - ▶ Press release button ① (> page 78) to disengage the gear selector lever lock.
  - ▶ Move the gear selector lever to drive position **D**.  
**D** appears in the transmission position indicator.
  - ▶ Release the brake pedal.  
The vehicle moves forward.
  - ▶ Depress the accelerator pedal smoothly.  
The vehicle accelerates.

#### **!** WARNING

On slippery road surfaces, never downshift in order to obtain braking action. This could result in drive wheel slip and reduced vehicle control. Your vehicle's ABS will not prevent this type of loss of control.

#### **!** WARNING

It is dangerous to shift the transmission out of park position **P** or neutral position **N** if the engine speed is higher than idle speed. If your foot is not firmly on the brake pedal, the vehicle could accelerate quickly forward or in reverse. You could lose control of the vehicle and hit someone or something. Only shift into gear when the engine is idling normally and when your right foot is firmly on the brake pedal.

- !** Do not run a cold engine at high engine speeds. Running a cold engine at high engine speeds may shorten the service life of the engine.
- !** Simultaneously depressing the accelerator pedal and applying the brakes reduces engine performance and causes premature brake and drivetrain wear.



### Reversing the vehicle

**!** Shift the transmission into reverse gear **R** only when the vehicle is stopped in order to avoid damaging the transmission.

You can drive in reverse gear at a speed of up to 9 mph (15 km/h).

- i** The vehicle has a crawler function. The vehicle moves forward when the brake pedal is released.
- ▶ Depress the brake pedal.
- ▶ Press the release button (▷ page 78) to disengage the gear selector lever lock.
- ▶ Move the gear selector lever to reverse gear **R**.  
**R** appears in the transmission position indicator.
- ▶ Release the brake pedal. The vehicle moves forward.
- ▶ Depress the accelerator pedal smoothly. The vehicle accelerates.

### Parking

#### **WARNING**

Do not park this vehicle in areas where combustible materials such as grass, hay or leaves can come into contact with the hot exhaust system. These materials could be ignited and cause a vehicle fire.



Vehicle movement can cause serious personal injury or damage to the vehicle or the vehicle drivetrain. Therefore, always do the following before turning off the engine and leaving the vehicle:

- Keep right foot on the brake pedal.
- Engage the parking brake.
- Move the gear selector lever to park position **P**.
- Slowly release the brake pedal.
- When parked on an incline, always turn the front wheels towards the curb.

- Turn the key to starter switch position **0** and remove the key from the starter switch.
- Take the key with you and lock the vehicle when leaving.

#### **WARNING**

With the engine not running, there is no power assistance for the brake and steering\* systems. In this case, it is important to keep in mind that a considerably higher degree of effort is necessary to brake and steer the vehicle. Adapt your driving accordingly.

- ▶ Properly stop and park the vehicle.
- ▶ Depress the brake pedal.
- ▶ Engage the parking brake (▷ page 79).  
When the ignition is switched on or the engine is running, the brake warning lamp  (USA only) or  (Canada only) in the instrument cluster comes on.
- ▶ Release the brake pedal.

### Parking brake

The parking brake serves to secure the vehicle against rolling away when it is stationary or parked.

#### **WARNING**

Engaging the parking brake while the vehicle is in motion can cause the rear wheels to lock up. You could lose control of the vehicle and cause an accident. In addition, the vehicle's brake lights do not light up when the parking brake is engaged.

\* optional

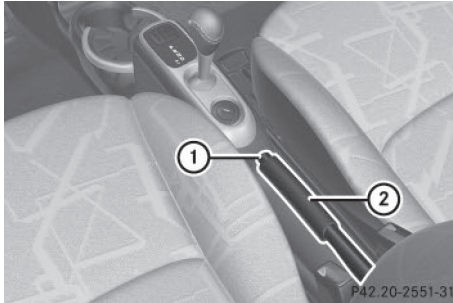

- ▶ **Releasing:** Depress the brake pedal.
- ▶ Pull up slightly on parking brake lever ② and press release button ①.
- ▶ Push parking brake lever ② down as far as it will go.  
When the ignition is switched on or the engine is running, the brake warning lamp **BRAKE** (USA only) or **(P)** (Canada only) in the instrument cluster goes out.
- ▶ **Engaging:** Pull up parking brake lever ② firmly.  
When the ignition is switched on or the engine is running, the brake warning lamp **BRAKE** (USA only) or **(P)** (Canada only) in the instrument cluster comes on.

#### **WARNING**

Getting out of your vehicle with the transmission not fully engaged in park position **P** is dangerous. When the engine is shut off and the brakes are released, the vehicle can be moved freely with the gear selector lever in all positions except park position **P**. Also, when parked on an incline, park position **P** alone may not prevent your vehicle from moving, possibly hitting people or objects.

Always engage the parking brake in addition to shifting to park position **P**.

When parked on an incline, always turn the front wheels towards the curb.

#### **WARNING**

When leaving the vehicle, always remove the key from the starter switch, take it with

you, and lock the vehicle. Do not leave children unattended in the vehicle, or with access to an unlocked vehicle. Children could release the parking brake and/or move the gear selector lever from park position **P**, either of which could result in an accident and/or serious personal injury.

### **Brake pedal**

The brake pedal has two brake circuits independent of each other. A brake servo is used during braking (when the engine is running) to increase pedal force.

#### **WARNING**

Make sure absolutely no objects are obstructing the pedals' range of motion. Keep the driver's footwell clear of all obstacles. If there are any floor mats\* or carpets in the footwell, make sure the pedals still have sufficient clearance.

During sudden acceleration or braking maneuvers, the objects could get caught between or beneath the pedals and restrict your ability to brake or accelerate. This could lead to accidents and/or injury.

#### **WARNING**

Considerably more effort will be required to apply the brakes if

- the brake servo has failed
- a brake circuit has failed
- the engine is switched off, e.g. for towing the vehicle

The braking distance is likewise greater. Make sure the engine is running whenever the vehicle is rolling. Have the brake system repaired at an authorized smart center, if there is a fault in the brake system.



If a brake circuit has failed (▷ page 164), you must depress brake pedal ① further down to achieve the same effect and the braking distance is increased.

- ① The brake servo will only function with the engine switched on.

#### WARNING

In the event of the vehicle needing to be towed, a significantly greater amount of pedal pressure will be required when the engine is switched off.

#### Turning off the engine

#### WARNING

Do not turn off the engine before the vehicle has come to a complete stop. With the engine not running, there is no power assistance for the brake and steering\* systems. In this case, it is important to keep in mind that a considerably higher degree of effort is necessary to brake and steer the vehicle.

- ▶ Depress the brake pedal.
- ▶ Press the release button (▷ page 78) to disengage the gear selector lever lock.
- ▶ Move the gear selector lever to park position **P**.  
The transmission position indicator should be on **P**.

❗ Always engage the parking brake in addition to shifting to park position **P**.

\* optional

- ▶ Release the brake pedal.
- ▶ Turn the key to starter switch position **0**.
- ▶ Remove the key from the starter switch. The electronic immobilizer is activated.

## Transmission

### Introduction

Your vehicle is equipped with a 5-speed automated transmission with manual or automatic mode. For information on driving with the transmission see also "Starting" (▷ page 77).

#### WARNING

Make sure absolutely no objects are obstructing the pedals' range of motion. Keep the driver's footwell clear of all obstacles. If there are any floor mats\* or carpets in the footwell, make sure the pedals still have sufficient clearance.

During sudden acceleration or braking maneuvers, the objects could get caught between or beneath the pedals and restrict your ability to brake or accelerate. This could lead to accidents and/or injury.

#### Gear selector lever

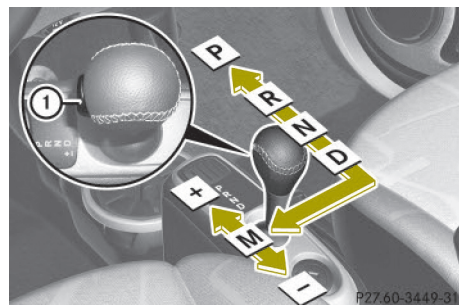

Gearshift pattern for transmission

- ① Release button

<b>P</b>	Park position
<b>R</b>	Reverse gear
<b>N</b>	Neutral position
<b>D</b>	Drive position
<b>M</b>	Manual gearshifting
<b>+</b>	Upshifting
<b>-</b>	Downshifting

The current gear selector lever position appears in the transmission position indicator. When manual gearshifting **M** is selected, the currently selected gear appears (▷ page 87).

#### **WARNING**

It is dangerous to shift the transmission out of park position **P** or neutral position **N** if the engine speed is higher than idle speed. If your foot is not firmly on the brake pedal, the vehicle could accelerate quickly forward or in reverse. You could lose control of the vehicle and hit someone or something. Only shift into gear when the engine is idling normally and when your right foot is firmly on the brake pedal.

### Shifting procedure

The transmission selects individual gears automatically, depending on:

- the gear selector lever position **D** (▷ page 83)
- the position of the accelerator pedal (▷ page 83)
- the vehicle speed
- uphill or downhill grades

Press release button **1** (▷ page 81) to disengage the gear selector lever lock when moving the gear selector lever from

- **P** to **R**, **N**, or **D**
- **R** to **P**
- **N** to **R** or **P**

**!** Allow the engine to warm up under low load use. Do not place full load on the engine until the operating temperature has been reached.

Shift into reverse gear **R** or parking position **P** only when the vehicle is stopped.

Avoid spinning of a drive wheel for an extended period when driving off on slippery road surfaces. Otherwise, the drivetrain could be damaged, which is not covered by the smart Limited Warranty.

With manual gearshifting **M** selected (▷ page 84), you can use the gear selector lever or steering wheel gearshift control to change the gears manually.

## Gear selector lever positions

	Effect
<b>P</b>	<p><b>Park position</b></p> <p>Gear selector lever position when the vehicle is parked. Place the gear selector lever in park position <b>P</b> only when the vehicle is stopped. The park position is not intended to serve as a brake when the vehicle is parked.</p> <p>Rather, the driver should always engage the parking brake in addition to placing the gear selector lever in park position <b>P</b> to secure the vehicle.</p> <p>The key can only be removed from the starter switch with the gear selector lever in park position <b>P</b>. With the key removed, the gear selector lever is locked in park position <b>P</b>.</p>
<b>R</b>	<p><b>Reverse gear</b></p> <p>Shift into reverse gear <b>R</b> only when vehicle is stopped.</p>
<b>N</b>	<p><b>Neutral position</b></p> <p>No power is transmitted from the engine to the drive axle. When the brakes are released, the vehicle can be moved freely (pushed or towed).</p>
<b>D</b>	<p><b>Drive position</b></p> <p>The transmission shifts automatically.</p>
<b>M</b>	<p><b>Manual gearshifting</b></p> <p>System-controlled automatic gearshifting is switched off. The driver has to change the gears manually.</p>

The current gear selector lever position appears in the transmission position indicator (▷ page 87).

### Driving tips

#### Accelerator pedal position

Your driving style influences the transmission's shifting behavior:

- Less throttle earlier upshifting
- More throttle later upshifting

#### Kickdown

Use kickdown when you want maximum acceleration.

- ▶ Press the accelerator pedal past the point of resistance. Depending on the engine speed the transmission shifts into a lower gear.
- ▶ Ease up on the accelerator pedal when you have reached the desired speed. The transmission shifts up again.

#### Stopping

When you stop briefly, e.g. at traffic lights:

- ▶ Leave the transmission in gear.
- ▶ Hold the vehicle with the brake.

When you stop for a longer period with the engine idling and/or on a hill:

- ▶ Engage the parking brake.
- ▶ Move the gear selector lever to park position **P**.

#### Working on the vehicle

##### WARNING

When working on the vehicle, engage the parking brake and move the gear selector lever to park position **P**. Otherwise the vehicle could roll away which could result

in an accident and/or serious personal injury.

### Driving on uphill grades

#### WARNING

The hill-start assist system is not designed to function as a parking brake and does not prevent the vehicle from moving when parked on an incline.

Always engage the parking brake in addition to shifting to park position **P**.

>> Controls.

**!** When the hill-start assist system stops braking the vehicle, it can roll backwards.

If you open the driver's door, the hill-start assist system is deactivated and a warning signal sounds.

Your vehicle has a hill-start assist system. On uphill grades the hill-start assist system maintains the pressure in the brake system for approximately one second after you have released the brake pedal. Therefore, you can start off smoothly without the vehicle moving immediately after releasing the brake pedal.

- ▶ Release the brake pedal.
- ▶ Apply sufficient pressure to the accelerator pedal to drive off.

On uphill grades with higher inclination, the hill-start assist system will release the pressure in the brake system after approximately two seconds. A warning signal sounds and the transmission position indicator shows a flashing **N** in order to warn you of the vehicle rolling backwards.

- ▶ Press the brake pedal.
- ▶ Release the brake pedal.
- ▶ Apply sufficient pressure to the accelerator pedal to drive off.

**i** The hill-start assist system is inactive if you start off with the parking brake engaged.

### Manual gearshifting

With manual gearshifting **M** selected, system-controlled automatic gearshifting is switched off and you need to change the gears by upshifting or downshifting manually using the gear selector lever or the steering wheel gearshift control<sup>10</sup>.

**!** Allow the engine to warm up under low load use. Do not place full load on the engine until the operating temperature has been reached.

Shift into reverse gear **R** or parking position **P** only when the vehicle is stopped.

Avoid spinning of a drive wheel for an extended period when driving off on slippery road surfaces. Otherwise, the drivetrain could be damaged, which is not covered by the smart Limited Warranty.

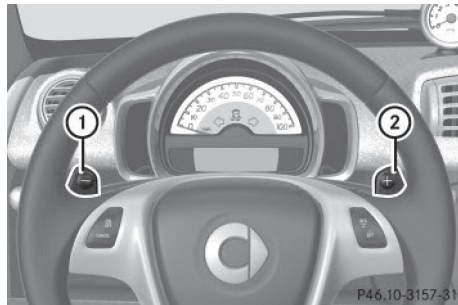

<sup>10</sup> Model passion and BRABUS only.

### Activating manual gearshifting

- ▶ Move the gear selector lever to drive position **D** (▷ page 81).
- ▶ Pull one of the shift paddles (▷ page 84) towards you.

or

- ▶ Move the gear selector lever to manual gearshifting **M** (▷ page 81). System-controlled automatic gearshifting is switched off. You can upshift or downshift through the gears in succession.

The currently engaged gear appears in the multifunction display (▷ page 84).

### Upshifting

- ▶ Briefly push the gear selector lever forward in the **+** direction (▷ page 81).

or

- ▶ Pull right shift paddle ② (▷ page 84) towards you. The transmission shifts to the next higher gear.

- ▶ **i** With manual gearshifting **M** selected, the transmission shifts up only to prevent engine overrevving.

### Downshifting

#### **WARNING**

On slippery road surfaces, never downshift in order to obtain braking action. This could result in drive wheel slip and reduced vehicle control. Your vehicle's ABS will not prevent this type of loss of control.

- ▶ Briefly pull the gear selector lever backward in the **-** direction (▷ page 81).
- or
- ▶ Pull left shift paddle ① (▷ page 84) towards you. The transmission shifts to the next lower gear.

### Kickdown

You can use kickdown when you want maximum acceleration.

- ▶ Press the accelerator pedal past the point of resistance. Depending on the engine speed the transmission shifts into a lower gear.
  - ▶ When you have reached the desired speed, briefly push the gear selector lever forward in the **+** direction (▷ page 81).
- or
- ▶ Pull right shift paddle ② (▷ page 84) towards you. The transmission shifts to the next higher gear.

### Deactivating manual gearshifting

- ▶ With drive position **D** selected: Pull and hold right shift paddle ② (▷ page 84) towards you for longer than two seconds.
- or
- ▶ With manual gearshifting **M** selected: Move the gear selector lever to drive position **D** (▷ page 81). System-controlled automatic gearshifting is switched on again.

### Emergency operation (limp-home mode)

In this mode only a certain gear or a certain gear combination can be selected. This mode is triggered in case of transmission malfunctions and enables you driving to the nearest workshop such as a smart center.

If vehicle acceleration becomes less responsive or sluggish or the transmission no longer shifts, the transmission is most likely operating in limp-home (emergency operation) mode. The transmission position indicator flashes and the  symbol appears in the multifunction display.

Driving in limp-home mode:

- ▶ Move the gear selector lever to drive position **D** (▷ page 81).
- ▶ Continue to drive.
- ▶ Have the transmission checked at an authorized smart center as soon as possible.

**i** It is possible that a gear combination including the reverse gear can not be selected. Keep in mind when parking, that reversing the vehicle might be impossible.

In case of a minor transmission malfunction, it might be possible to teach-in the transmission in order to restore the normal transmission mode.

**i** If the attempt to teach-in the transmission fails, you cannot continue to drive. Therefore we strongly recommend that you have the transmission taught-in at a qualified workshop or at an authorized smart center.

#### Teaching-in the transmission system:

- ▶ Stop the vehicle in a safe location.
- ▶ Move the gear selector lever to park position **P**.
- ▶ Turn off the engine.
- ▶ Wait at least 30 seconds before restarting.
- ▶ Press the brake pedal.
- ▶ Restart the engine  
Three bars instead of **P** appear in the multifunction display.
- ▶ Wait at least 30 seconds.  
The transmission is taught in.

**When teaching-in was successful:** **P** appears in the multifunction display again and normal transmission operating is restored.

- ▶ Continue to drive.

**After an unsuccessful teaching-in:** Three bars instead of **P** appear in the multifunction display.

- ▶ Do not continue to drive.
- ▶ Turn off the engine.
- ▶ Engage the parking brake when leaving the vehicle.
- ▶ Contact Roadside Assistance or an authorized smart center.

## Instrument cluster

### Multifunction display

The following displays and indicators appear in the multifunction display:

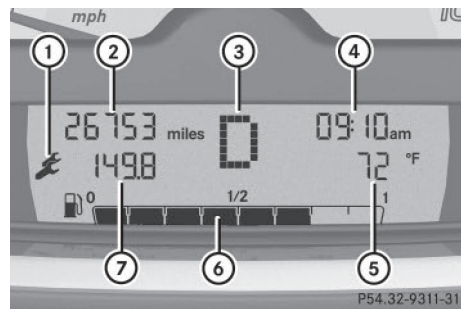

Multifunction display (U.S. vehicles)

- ① Maintenance service symbol (status indicator)
- ② Main odometer display and days or distance to next maintenance service
- ③ Transmission position indicator
- ④ Digital clock
- ⑤ Outside temperature display
- ⑥ Fuel level display
- ⑦ Status indicator with:
  - Trip odometer display
  - Reserve fuel indicator



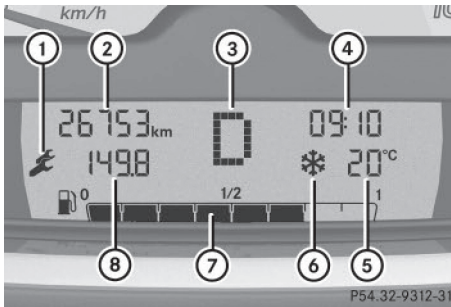

Multifunction display (Canada vehicles)

- ① Maintenance service symbol (status indicator)
- ② Main odometer display and days or distance to next maintenance service
- ③ Transmission position indicator
- ④ Digital clock
- ⑤ Outside temperature display
- ⑥ Freeze warning
- ⑦ Fuel level display
- ⑧ Status indicator with:
  - Trip odometer display
  - Reserve fuel indicator

#### **WARNING**

No messages will be displayed if either the instrument cluster or the multifunction display is inoperative.

As a result, you will not be able to see information about your driving conditions, such as speed, outside temperature, or warning/indicator lamps. Driving characteristics may be impaired.

If you must continue to drive, please do so with added caution. Visit an authorized smart center as soon as possible.

#### **Multifunction display illumination**

The multifunction display illumination comes on when the starter switch is in position **1**. It goes out after approximately 30 seconds when the starter switch is in position **0**.

For adjusting the multifunction display illumination, see "Adjusting instrument cluster illumination" (> page 92).

#### **Main odometer display**



Example illustration (U.S. vehicles)

- i** Canada vehicles: The main odometer display shows **km** instead of **miles**.

The main odometer display appears in the multifunction display continuously.

Exception: The next maintenance service is due. After starting the engine, days or distance to next maintenance service will appear instead of the main odometer display. The main odometer display will reappear after approximately ten seconds.

For information on how to select the maintenance service interval display, see "Maintenance service interval display" (> page 90).

#### **Transmission position indicator**

The following information is displayed in the transmission position indicator:

- Current gear selector lever position
- Current engaged gear (when manual gear-shifting selected)

- i** A flashing **R** in the display indicates that the gear selector lever is in position **R** but the reverse gear is not engaged. Stop the vehicle to let the reverse gear engage.



Example illustration (U.S. vehicles)

Display	Function
P	Gear selector lever in park position <b>P</b>
R	Gear selector lever in position <b>R</b> (Reverse gear engaged)
N	Gear selector lever in neutral position <b>N</b>
D	Gear selector lever in drive position <b>D</b>

When manual gearshifting is selected:

Display	Function
1	First gear engaged
2	Second gear engaged
3	Third gear engaged
4	Fourth gear engaged
5	Fifth gear engaged

## Digital clock



Example illustration (U.S. vehicles)

- i** Canada vehicles: The digital clock shows a 24 h-clock instead of a 12 h-clock.

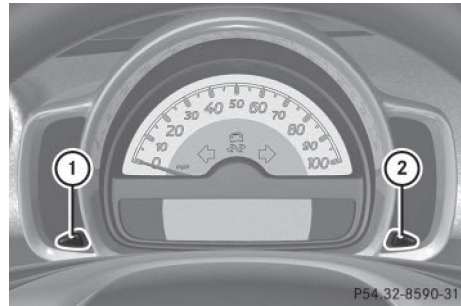

The time can only be set as long as the colon in the digital clock flashes.

- ▶ **Activating time setting:** Press and hold right button ② until the colon in the digital clock starts flashing.
- ▶ **Setting the time in 1 minute increments:** Press left button ① or right button ② repeatedly until the desired time is set.
- ▶ **Setting the time quickly:** Press left button ① or right button ② for longer than one second. The setting speed increases.
- ▶ **Setting the time in 10 minute increments:** Press left button ① or right button ② for longer than five seconds. The time is set in 10 minute increments.

- ▶ **Confirm time setting:** Refrain from pressing either left button ① or right button ② until the colon in the digital clock stops flashing. The time is set.

❗ The digital clock in the multifunction display is not synchronized with the cockpit clock\* (> page 91).

### Outside temperature display

#### ⚠ WARNING

The outside temperature display is not designed as an ice-warning device and is therefore unsuitable for that purpose.

Indicated temperatures just above the freezing point do not guarantee that the road surface is free of ice. The road may still be icy, especially in wooded areas or on bridges. Your vehicle could start to skid if you do not adjust your driving style accordingly.

Therefore, always adjust your driving style to the prevailing road and weather conditions.



Example illustration (U.S. vehicles)

❗ Canada vehicles: The outside temperature display shows °C instead of °F.

The outside temperature display appears in the multifunction display continuously. A change of the outside temperature will be displayed with delay.

### Freeze warning (Canada vehicles only)



When the outside temperature falls below 3°C, the multifunction display makes you aware of the fact that the road may be icy. An additional freeze warning, i.e. an ice crystal symbol, in the multifunction display flashes. After 60 seconds, the freeze warning stops flashing but continues to be displayed. When the outside temperature rises above 3°C, the freeze warning goes out.

### Fuel level display



Example illustration (U.S. vehicles)

The fuel level display shows the tank's fuel level with the aid of eight segments. The number of dark segments indicates the fuel level in the tank. If all eight segments are dark, the tank is full.

You are driving on reserve fuel if there are no more than 1.0 US gal (3.78 l) of fuel in the tank.

\* optional

If this occurs,

- the fuel pump symbol in the fuel level display flashes
- the reserve fuel indicator shows the fuel level in the tank in 0.1 US gal (0.5 l) increments

For selecting the reserve fuel indicator to be displayed in the status indicator, see "Reserve fuel indicator" (▷ page 91).

### Selecting display for status indicator

You can select the information to be displayed in the status indicator:

- Trip odometer display (▷ page 90)
- Maintenance service interval display (▷ page 90)
- Reserve fuel indicator (▷ page 91) (when less than 1.0 US gal (3.78 l) of fuel is in the tank)

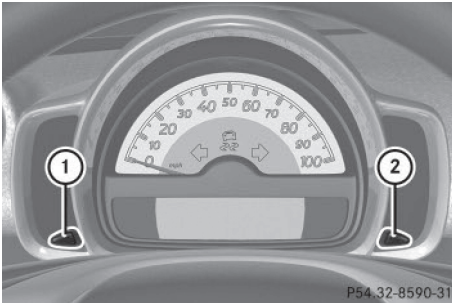

- ① Selecting display for status indicator, setting the clock, activating maintenance service interval display
- ② Setting the clock, adjusting instrument cluster illumination

### Trip odometer display



Example illustration (U.S. vehicles)

- ▶ **Selecting trip odometer display:** Press left button ① (▷ page 90) repeatedly until the trip odometer display appears in the status indicator.
- ▶ **Resetting trip odometer display:** Press and hold left button ① (▷ page 90) until the value is set to 0.

### Maintenance service interval display



Example illustration (U.S. vehicles)

- ❗ **Canada vehicles:** The maintenance service interval display shows **km** instead of **miles**.

The maintenance service interval display will notify you approximately one month before the next maintenance service is due.



The following information will be displayed after starting the engine:

- Days or distance to next maintenance service

This information will be displayed instead of the main odometer display. The main odometer display will reappear after approximately ten seconds (> page 87).

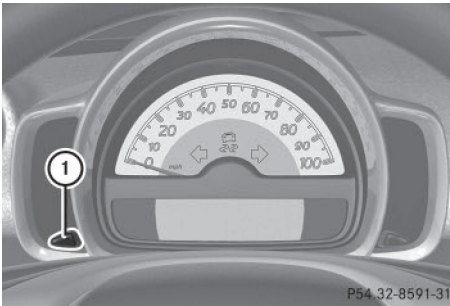
- Type of service that is due  
This information will be displayed in the status indicator.
- ▶ Start the engine.



- ▶ **Selecting maintenance service interval display:** Press button ① on the instrument cluster repeatedly until the maintenance service interval display appears in the status indicator. Depending on the type of maintenance service that is due, symbol  or  is displayed.
- ▶ **Clearing maintenance service interval display:** Press button ① once. The maintenance service interval display is cleared.
- ▶ **Activating maintenance service interval display:** Press button ① twice in quick succession.

### Reserve fuel indicator



Example illustration (U.S. vehicles)

The reserve fuel indicator is only displayed when driving on reserve fuel.

- ▶ **Selecting reserve fuel indicator:** Press button ① on the instrument cluster repeatedly until the reserve fuel indicator appears in the status indicator.

### Auxiliary instruments\*

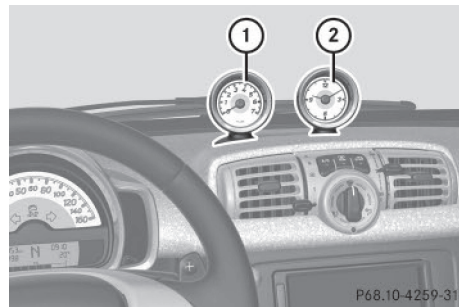

- ① Tachometer
- ② Cockpit clock

### Tachometer\*

The tachometer displays the engine speed in units of 1000 rpm.

The tachometer can be turned by approximately 90°.

The tachometer illumination comes on when you switch on the ignition and the exterior lighting.

\* optional

❗ Do not hang any objects on the tachometer.

This could cause the tachometer to be torn from its mountings and damage it.

### Cockpit clock\*

The cockpit clock can be turned by approximately 90°.

The cockpit clock illumination comes on when you switch on the ignition and the exterior lighting.

The buttons for setting the time are on the top of the cockpit clock.

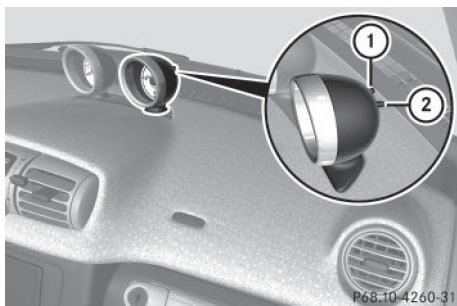

▶ **Setting the time back in 1 minute increments:** Press button ① repeatedly until the desired time is set.

▶ **Setting the time back quickly:** Press button ① for longer than two seconds. The setting speed accelerates.

▶ **Setting the time forward in 1 minute increments:** Press button ② repeatedly until the desired time is set.

▶ **Setting the time forward quickly:** Press button ② for longer than two seconds. The setting speed accelerates.

❗ Do not hang any objects on the cockpit clock.

This could cause the cockpit clock to be torn from its mounting and damage it.

### Adjusting instrument cluster illumination

You can adjust the illumination of the switches, the dials in the instrument cluster, the radio\*, the climate control\* panel and the auxiliary instruments\*. Five illumination levels are available.



- ▶ Make sure the key is in starter switch position 1.
- ▶ Switch on the parking lamps.
- ▶ **To brighten or dim illumination:** Press button ① on the instrument cluster repeatedly until the desired setting is reached. The current setting is stored.

## Control system\*

### Introduction

The control system is activated when you turn the key in the starter switch to position 1.

#### ⚠ WARNING

A driver's attention to the road and traffic conditions must always be his/her primary focus when driving.

In order to avoid distraction which could lead to an accident, the driver should select features and change settings in the control system only vehicle at a standstill or when traffic and road conditions permit it to be done safely.

Bear in mind that at a speed of just 30 mph (approximately 50 km/h), your vehicle is covering a distance of 44 feet (approximately 14 m) every second.

message **Back** appears in the multifunction display.

- ▶ Press the OK button on the control lever briefly.

### Control lever

You can select the displays in the multifunction display and change settings in the control system with the control lever.

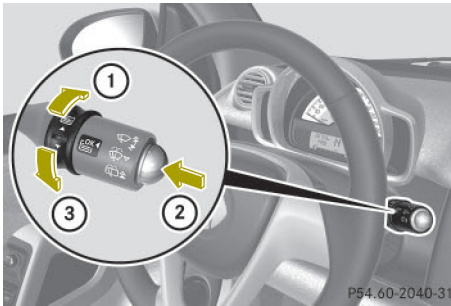

Control lever (example illustration coupé)

①	<b>Control switch</b> Pressing up selects a menu.
②	<b>OK button</b> Confirming a selection. Scrolling through stored messages in the <b>Messages</b> menu
③	<b>Control switch</b> Pressing down selects a menu.

### Multifunction display

The multifunction display shows values and settings as well as display messages.

- ▶ **Activating the multifunction display:**  
Unlock the vehicle.
- ▶ **Confirming messages:** Press the OK button on the control lever briefly (▷ page 93).
- ▶ **Exiting menu:** Press the control switch on the control lever up or down until the

\* optional

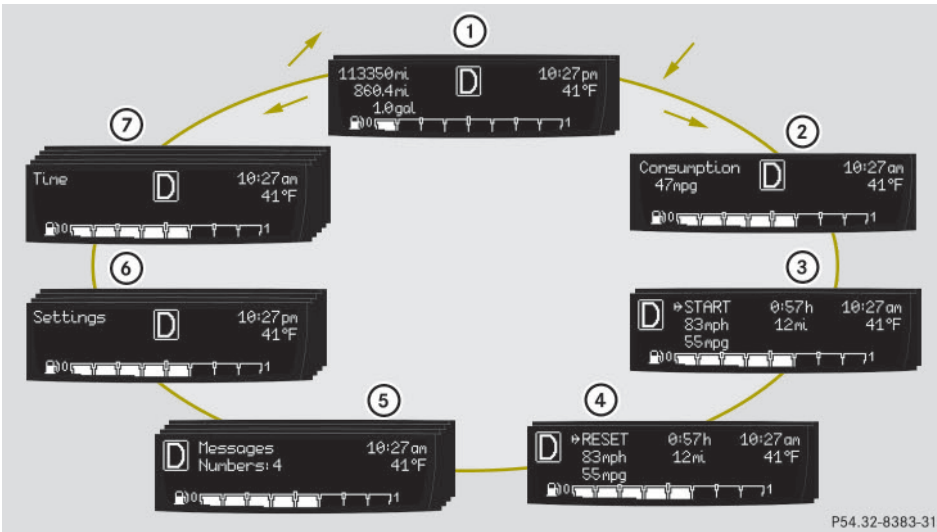
**Menus and submenus**

P54.32-8383-31

	Function
①	Odometer menu (▷ page 94)
②	Consumption menu (▷ page 95)
③	→START menu (trip statistics since start) (▷ page 95)
④	→RESET menu (trip statistics since last reset) (▷ page 95)
⑤	Messages menu (▷ page 96)
⑥	Settings menu (▷ page 96)
⑦	Time menu (▷ page 97)

**Odometer menu**

The **Odometer** menu shows you either the main odometer and the trip odometer or the trip odometer with the amount of fuel left in the fuel tank.

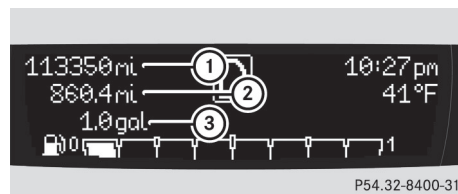

P54.32-8400-31

- ① Main odometer
- ② Trip odometer
- ③ Remaining fuel

► Press the control switch on the control lever (▷ page 93) up or down until the

\* optional



**Odometer** menu appears in the multi-function display.

- ▶ **To switch between submenus:** Press the OK button on the control lever briefly.
- ▶ **To reset the trip odometer:** Select the trip odometer display.
- ▶ Press button ⑥ on the instrument cluster until the trip odometer is reset to 0 (▷ page 21).

### Consumption menu

The **Consumption** menu shows you the current fuel consumption.

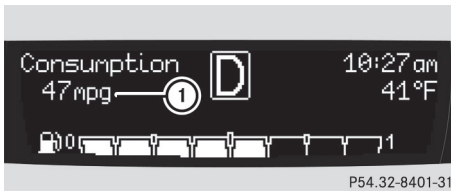

- ▶ Press the control switch on the control lever (▷ page 93) up or down until the **Consumption** menu appears in the multi-function display. The current current fuel consumption appears.

**i** Depending on the selected unit in the settings menu (▷ page 96), the consumption is displayed in miles per gallon (mpg) or in liters per 100 kilometers (l/100 km).

**Canada only:** When the vehicle is standing, the fuel consumption is displayed in gallons per hour (gal/h) or liters per hour (l/h).

### Start menu

The **→START** menu shows you the trip statistics since start.

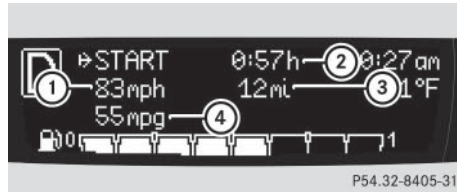

- ① Average speed since start
- ② Time elapsed since start
- ③ Distance driven since start
- ④ Average fuel consumption since start

- ▶ Press the control switch on the control lever (▷ page 93) up or down until the **→START** menu appears in the multifunction display.

- ▶ **To reset:** Press button ⑥ on the instrument cluster until the **→START** menu is reset to 0 (▷ page 21).

**i** The **→START** menu is reset to 0 automatically

- when the ignition has been switched off for more than 4 hours
- after driving more than 9 999 miles or kilometers

### Reset menu

The **→RESET** menu shows you the trip statistics since the last reset.

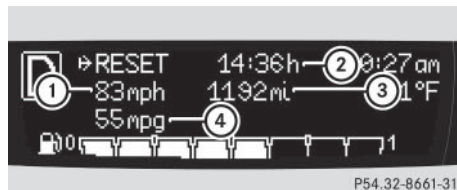

- ① Average speed since last reset
- ② Time elapsed since since last reset
- ③ Distance driven since last reset
- ④ Average fuel consumption since since last reset

- ▶ Press the control switch on the control lever (▷ page 93) up or down until the

\* optional

→**RESET** menu appears in the multifunction display.

- ▶ **To reset:** Press button  on the instrument cluster until the →**RESET** menu is reset to 0 (▷ page 21).

### Messages menu

The **Messages** menu stores messages that you can call up.

- ❗ When no messages have been stored, the **Messages** menu is not displayed.

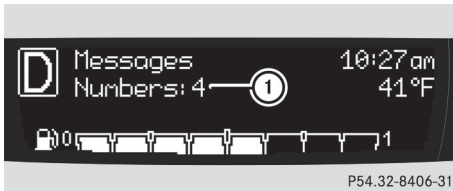

- ▶ Press the control switch on the control lever (▷ page 93) up or down until the **Messages** menu appears in the multifunction display.  
The number of stored messages is  displayed
- ▶ Press the OK button on the control lever briefly.  
The first stored message appears.
- ▶ **To scroll through messages:** Press the OK button on the control lever briefly.

For more information on display messages, see (▷ page 158).

### Maintenance service interval display

The maintenance service interval display will notify you when the next maintenance service is due and what type of maintenance service is required.

Example:

-  Care Service in XXX mi
-  Main Service in XXX mi
-  Main Service in XX Days

- ▶ **To confirm:** Press the OK button on the control lever briefly.  
The message is stored.

When the due date for the maintenance service has been passed, the number of miles (kilometers) or days since are preceded by a minus sign.

- ❗ Failure to have the maintenance service performed at the designated times/mileage, may result in vehicle damage that is not covered by the smart Limited Warranty.

### Settings menu

In the **Settings** menu, you can select individual settings for your vehicle.

The following functions are available:

- Setting the language
- Setting the temperature unit
- Setting the distance and speed unit

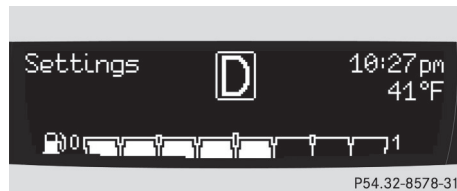

- ▶ Press the control switch on the control lever (▷ page 93) up or down until the **Settings** menu appears in the multifunction display.
- ▶ Press the OK button on the control lever briefly.

### Setting the language

The following languages are available:

- German
- US English
- UK English
- French
- Italian
- Spanish

\* optional

- ▶ Press the control switch on the control lever (▷ page 93) up or down until the **Language** submenu appears in the multi-function display.
- ▶ Press the OK button on the control lever briefly.
- ▶ Press the control switch on the control lever (▷ page 93) up or down until the desired language is selected.
- ▶ Press the OK button on the control lever briefly to confirm.  
The selected language is stored.

### Setting the temperature unit

The following units are available:

- °C
- °F
- ▶ Press the control switch on the control lever (▷ page 93) up or down until the **°F/°C** submenu appears in the multifunction display.
- ▶ Press the OK button on the control lever briefly.
- ▶ Press the control switch on the control lever (▷ page 93) up or down until the desired unit is selected.
- ▶ Press the OK button on the control lever briefly to confirm.  
The selected unit is stored.

### Setting the distance and speed unit

The following units are available:

- Miles (mi)
- Kilometers (km)
- ▶ Press the control switch on the control lever (▷ page 93) up or down until the **mi-km** submenu appears in the multifunction display.
- ▶ Press the OK button on the control lever briefly.

- ▶ Press the control switch on the control lever (▷ page 93) up or down until the desired unit is selected.
- ▶ Press the OK button on the control lever briefly to confirm.  
The selected unit is stored.

**i** Canada only: The unit for the cruise control (▷ page 100) does not change, regardless of which unit is set in this menu.

### Time menu

The **Time** menu lets you set the time and offers different display modes.

The following submenus are available:

- Setting time display mode (12-hour or 24-hour mode)
- Setting period of day, am or pm<sup>11</sup>
- Setting the hours
- Setting the minutes
- ▶ Press the control switch on the control lever (▷ page 93) up or down until the **Time** menu appears in the multifunction display.
- ▶ Press the OK button on the control lever briefly.

### Setting the time display mode

- ▶ Press the control switch on the control lever (▷ page 93) up or down until the **12h 24h** submenu appears in the multi-function display.
- ▶ Press the OK button on the control lever briefly.
- ▶ Press the control switch on the control lever (▷ page 93) up or down until the desired setting is selected.
- ▶ Press the OK button on the control lever briefly to confirm.  
The selected mode is stored.

<sup>11</sup> Only available in 12-hour mode.

\* optional

### Setting the period of day

- ▶ Press the control switch on the control lever (> page 93) up or down until the **am pm** submenu appears in the multifunction display.
- ▶ Press the OK button on the control lever briefly.
- ▶ Press the control switch on the control lever (> page 93) up or down until the desired setting is selected.
- ▶ Press the OK button on the control lever briefly to confirm.  
The selected mode is stored.

### Setting the hours

- ▶ Press the control switch on the control lever (> page 93) up or down until the **Hour** submenu appears in the multifunction display.
- ▶ Press the OK button on the control lever briefly.
- ▶ Press the control switch on the control lever (> page 93) up or down until the desired setting is selected.
- ▶ Press the OK button on the control lever briefly to confirm.  
The selected hours are stored.

### Setting the minutes

- ▶ Press the control switch on the control lever (> page 93) up or down until the **Minute** submenu appears in the multifunction display.
- ▶ Press the OK button on the control lever briefly.
- ▶ Press the control switch on the control lever (> page 93) up or down until the desired setting is selected.
- ▶ Press the OK button on the control lever briefly to confirm.  
The selected minutes are stored.

### Audio system\*

#### WARNING

In order to avoid distraction which could lead to an accident, the driver should enter system settings with the vehicle at a standstill and operate the system only when road and traffic conditions permit. Always pay full attention to traffic conditions first before operating system controls while driving.

Bear in mind that at a speed of just 30 mph (approximately 50 km/h), your vehicle is covering a distance of 44 feet (approximately 14 m) every second.

#### WARNING

Always select a volume that allows you to still hear ambient sound in your immediate vicinity (e.g. horns, emergency rescue vehicles, police vehicles, etc.). You could otherwise cause an accident.

#### WARNING

If you wish to have an audio system other than an original smart audio system fitted in your vehicle, please always have the necessary work performed at an authorized smart center.

This is particularly important if your vehicle is fitted with a radio preinstallation. Improper connection can result in the failure of important vehicle functions, thereby endangering the operating safety of your vehicle and thus your own safety and that of other people.

The following pages contain a brief description of the audio systems available for the coupé and cabriolet.

The devices are described with their full complement of equipment. The description for your individual equipment specification applies.

Please refer to the separate operating instructions for detailed functions.

**Audio system basic\***

The audio system basic contains the following functions:

- Radio (FM/AM)
- Radio Broadcast Data System (RBDS) and radio text
- AUX and USB socket (▷ page 99)

**!** Please be sure to read the operating instructions for the audio system basic before using the unit. Familiarize yourself with the various functions of the unit so that you are able to operate it easily, reliably and correctly at any time.

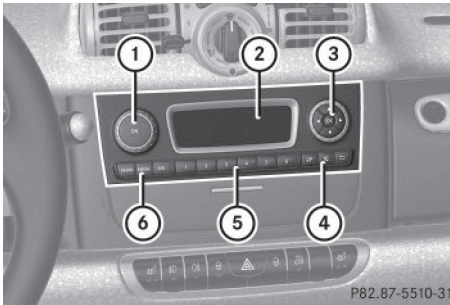

- ① On/off and volume switch
- ② Display
- ③ Skip/Scroll/Frequency search switches
- ④ Tone settings/Mute/Back control panel
- ⑤ Stored station buttons
- ⑥ Radio/Media/System control panel

**Audio system navigation/multimedia\***

The audio system navigation/multimedia contains the following functions:

- Radio (FM/AM)
- Radio Broadcast Data System (RBDS)
- AUX and USB-socket
- Bluetooth® hands-free device
- Navigation
- Audio operation from CD/DVD or SD Card, via AUX/USB/iPod®, or Bluetooth® Audio

\* optional

- Video operation from CD/DVD or SD Card, via AUX/USB/iPod®
- Image display from CD/DVD or SD Card, via USB/iPod®

**!** Please be sure to read the operating instructions for the audio system navigation/multimedia before using the unit. Familiarize yourself with the various functions of the unit so that you are able to operate it easily, reliably and correctly at any time.

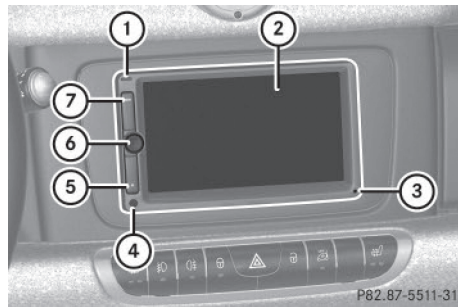

- ① Bluetooth® connection indicator lamp
- ② Display
- ③ Microphone
- ④ Light sensor
- ⑤ Eject button
- ⑥ Rotary/Push button
- ⑦ Menu button

**AUX and USB sockets\***

You can connect mobile audio devices such as an MP3 player via the AUX and USB sockets using commercially available 3.5 mm socket plug (AUX) or USB connector cable (USB).

The AUX and USB sockets are located in the glove box.

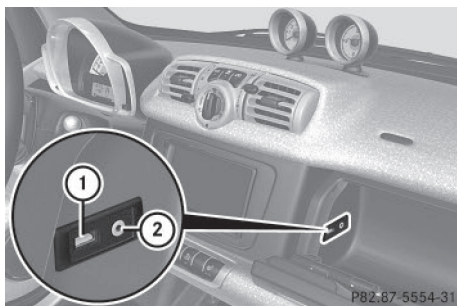

- ① USB socket
- ② AUX socket

### smart surround sound system\*

The smart surround sound system supplements the existing speakers with more powerful and additional speakers (including a digital amplifier in the passenger footwell and a passive subwoofer).

## Driving systems

### Cruise control\*

The cruise control maintains the speed you set for your vehicle automatically. On downhill grades, the cruise control does not brake the vehicle via the brake system. The cruise control can only use the braking power of the engine. You must apply the brakes yourself in order to reduce the vehicle speed. The cruise control will then be canceled.

#### WARNING

The cruise control is a convenience system designed to assist the driver during vehicle operation. The cruise control cannot take road, traffic, and weather conditions into account. The driver is and must always remain responsible for the vehicle's speed and for safe brake operation.

Do not use the cruise control

- if the road, traffic, and weather conditions do not make it advisable to travel at a constant speed
- on slippery roads  
Rapid changes in tire traction can result in wheel spin and loss of control.
- when driving in fog

The use of the cruise control is recommended for driving at a constant speed for extended periods of time.

With the cruise control is activated and a speed set, the following message appears in the multifunction display:

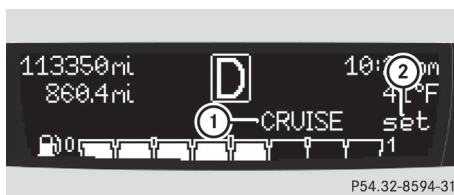

P54.32-8594-31

U.S. vehicles

- ① Cruise control activated
- ② Speed has been set

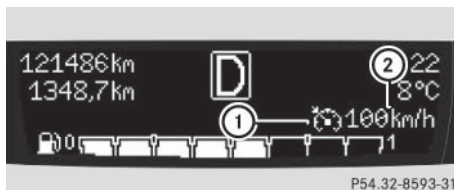

P54.32-8593-31

Canada vehicles

- ① Cruise control activated
- ② Set speed

The cruise control is operated via buttons on the steering wheel.

\* optional

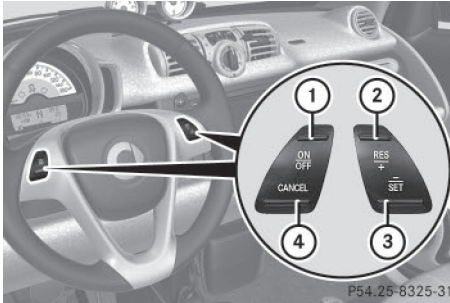

- ① Activating or deactivating the cruise control
- ② Resuming at last set speed or increasing speed
- ③ Setting current or lower speed, or decreasing speed
- ④ Canceling the cruise control

### Activating/deactivating

The cruise control must be activated before you can set a speed. When you turn off the engine, the cruise control is deactivated automatically.

- ▶ Press ON/OFF button ① briefly. The cruise control is activated. **CRUISE** (USA only) or  (Canada only) appears in the multifunction display.

### Setting current speed

You can set any speed above 20 mph (30 km/h).

- ▶ Accelerate the vehicle to the desired speed.
- ▶ With the cruise control activated, press SET/- button ③ briefly.
- ▶ Remove your foot from the accelerator pedal. The current speed is set and the vehicle maintains that speed. USA only: **set** appears in the multifunction display to indicate that the speed has been set.

Canada only: The set speed appears in the multifunction display next to cruise control symbol .

- ❗ On uphill grades, the cruise control may not be able to maintain the set speed. Once the grade eases, the set speed will be resumed.

On downhill grades, the cruise control can only maintain the set speed using the engine's braking power. You must apply the brakes yourself when the vehicle does not slow down sufficiently. This will cancel the cruise control.

### Canceling cruise control

When the cruise control is activated, you can cancel it at any time and resume the set speed later.

- ▶ Press CANCEL button ④ briefly.

or

- ▶ Depress the brake pedal. The cruise control is canceled.

The cruise control deactivates automatically, when

- you engage the parking brake
- the vehicle speed is below 20 mph (30 km/h)
- ESP® is in operation.

### Resuming last set speed

#### WARNING

The "Resume" function should only be operated if the driver is fully aware of the previously set speed and wishes to resume this particular preset speed.

The set speed stored in memory should only be set again if prevailing road conditions and legal speed limits permit. Possible acceleration or deceleration differences arising from returning to the preset speed could cause an accident and/or serious injury to you and others.

- ▶ Press RES/+ button ② briefly. The cruise control resumes the previously set speed.

**i** The last set speed stored in memory is deleted when the engine is turned off.

### Changing the set speed

You must have set a speed prior to increasing or decreasing the current speed.

**i** Depressing the accelerator pedal does not deactivate the cruise control. After a brief acceleration (e.g. for passing), the cruise control will resume the last set speed.

### Continuous adjustment

- ▶ Press and hold RES/+ button ② to increase the speed.
- or
- ▶ Press and hold SET/- ③ to decrease the speed.
- ▶ Press and hold the respective button until the desired speed is reached.
- ▶ Release the respective button. The new speed is stored.

### Adjustment in 1 mph (Canada 1 km/h) increments

- ▶ Press RES/+ button ② briefly to increase the speed.
- or
- ▶ Press SET/- ③ briefly to decrease the speed.

The new speed is stored after releasing the respective button.

pages. Otherwise the windows could fog up, impairing visibility and endangering you and others.

### Air conditioning with climate control\*

The air conditioning improves the level of comfort when driving at high outside temperatures by cooling and dehumidifying the air.

Nearly all dust particles, pollutants, are filtered out by an integrated particle filter before outside air enters the passenger compartment through the air distribution system. It also operates when the air conditioning is switched off and you have switched on the blower.

The air conditioning only works when the engine is running and the blower is switched on. Maximum effectiveness is achieved if you drive with the windows closed.

**i** In warmer weather, ventilate the passenger compartment for a short period of time before utilizing the air conditioning.

### HVAC (Heating, Ventilation, Air Conditioning)

#### Notes on HVAC

#### WARNING

Follow the recommended settings for heating and cooling given on the following



## Control panels HVAC

## Heating

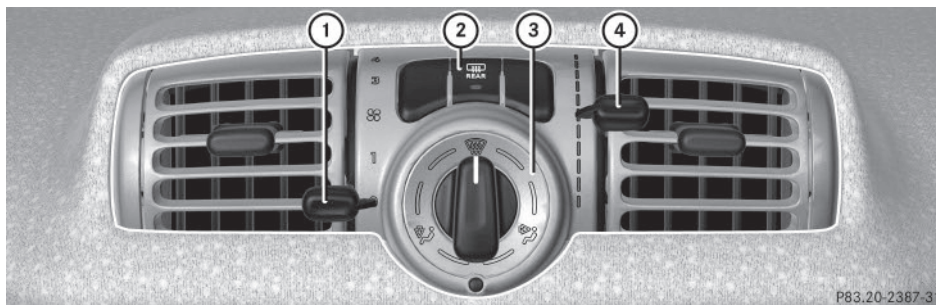

- ① Air volume control
- ② Rear window defroster switch
- ③ Air distribution control
- ④ Temperature control

## Air conditioning with climate control\*

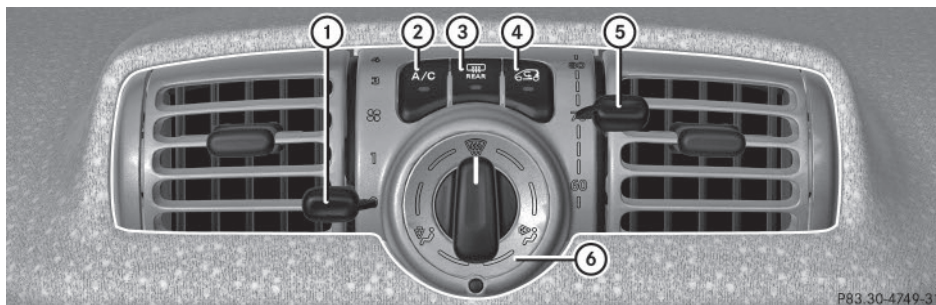

- ① Air volume control
- ② Air conditioning switch
- ③ Rear window defroster switch
- ④ Air recirculation switch
- ⑤ Temperature control
- ⑥ Air distribution control

## Switching HVAC on/off

## Heating

Control panel (> page 103).

- ▶ **Switching on:** Make sure the key is in starter switch position 1.
- ▶ Push temperature control ④ up.
- ▶ **Switching off:** Push temperature control ④ fully down.

\* optional

### Air conditioning with climate control\*

Control panel (▷ page 103).

- ▶ Make sure the engine is running.
- ▶ **Switching on:** Push air volume control ① to level 1 or higher.
- ▶ Press air conditioning switch ②. The indicator lamp in air conditioning switch ② comes on.
- ▶ **Switching off:** Press air conditioning switch ② once more. The indicator lamp in air conditioning switch ② goes out.

**i** The stored status is restored, if you switch on the ignition again.

**i** The air condition will be suspended temporarily:

- if the engine speed is too low
- when driving off

The air condition is switched off:

- at a coolant temperature of more than 239°F (115°C)
- at outside temperatures below 38°F (3°C)

### Setting the temperature

#### Heating



Control panel (▷ page 103).

- i** You should raise or lower the temperature setting in small increments.
- ▶ **Increasing or decreasing:** Push temperature control ④ up or down.

#### Rapid cooling

- ▶ Push air volume control ① fully up.
- ▶ Turn air distribution control ③ to position .
- ▶ Push temperature control ④ fully down.
- ▶ Adjust the air vents as desired.

#### Rapid heating

- ▶ Push air volume control ① to level 3.
- ▶ Turn air distribution control ③ to a position between  and .
- ▶ Push temperature control ④ fully up.
- ▶ Adjust the air vents towards the occupants.

### Air conditioning with climate control\*

Control panel (▷ page 103).

**i** You should raise or lower the temperature setting in small increments, preferably starting at 70°F (21°C).

- ▶ **Increasing or decreasing:** Push temperature control ⑤ up or down.

### Adjusting air vents

#### WARNING

When operating the heating or air conditioning with climate control\*, the air that enters the passenger compartment through the air vents can be very hot or very cold (depending on the set temperature). This may cause burns or frostbite on unprotected skin in the immediate area of the air vents. Always keep sufficient distance between unprotected parts of the body and the air vents. If necessary, use the air distribution control to direct the air to air vents in the vehicle interior that are not in the immediate area of unprotected skin.

To make sure the heating or air conditioning with climate control\* works properly, please observe the following:

- Keep the air intake grill free from deposits, e.g. ice or snow, to ensure that fresh air can flow freely into the vehicle interior.
- Do not obstruct air vents or ventilation grilles in the vehicle interior.

\* optional

- i** For draft-free ventilation, move the sliders for the center air vents and side air vents to the middle position.

**Center air vents**

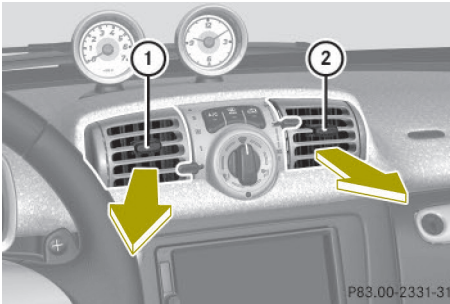

- ① Left center air vent, adjustable
- ② Right center air vent, adjustable

- ▶ **Adjusting:** Turn slider ① or ② to the left, right, up, or down.
- ▶ **Opening:** Turn slider ① or ② inwards towards the center console.
- ▶ **Closing:** Turn slider ① or ② fully outwards towards the side window.

**Side air vents**

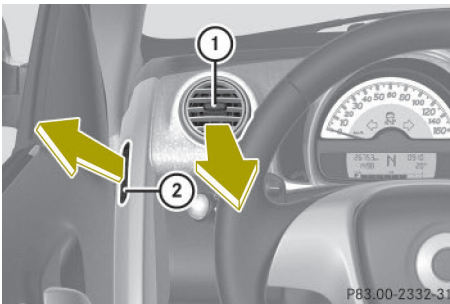



Side air vents on driver's side illustrated as example

- ① Left side air vent, adjustable
- ② Left side defroster air vent, fixed

- ▶ **Adjusting:** Turn slider ① to the left, right, up, or down.
- ▶ **Opening:** Turn slider ① inwards towards the center console.
- ▶ **Closing:** Turn slider ① fully outwards towards the side window.

**Adjusting air distribution**

Symbol	Function
	Directs air to the windshield and side windows
	Directs air to the footwells and air distribution is reduced at the center and side air vents
	Directs air through the center and side air vents

- i** You can also turn the air distribution control to a position between two symbols.

**Heating**

Control panel (▷ page 103).

- ▶ Turn air distribution control ③ to the desired symbol. The air distribution is controlled depending on the position of the air distribution control.

**Air conditioning with climate control**

Control panel (▷ page 103).

- ▶ Turn air distribution control ⑥ to the desired symbol. The air distribution is controlled depending on the position of the air distribution control.

### Adjusting air volume

The air volume is controlled depending on the blower speed selected. Five blower speeds are available.

0	Off
1	Slow
2	Medium
3	High/defrosting
4	Maximum

- ▶ **Increasing or decreasing:** Push air volume control ① up or down.

### Defrosting

#### WARNING

Never drive with iced up or fogged windows. Visibility will be significantly impaired. Impaired visibility could endanger yourself and others. This may prevent you from observing the traffic conditions, thereby causing an accident.

The best defrosting of windows is achieved if the ice is completely removed from the windows manually with an ice scraper before starting the engine.

### Heating

Control panel (▷ page 103).

- ▶ **Switching on:** Push air volume control ① to level 3.
- ▶ Turn air distribution control ③ to position .
- ▶ Push temperature control ④ fully up.

### Air conditioning with climate control

Control panel (▷ page 103).

- ▶ **Switching on:** Push air volume control ① to level 3.
- ▶ Turn air distribution control ⑥ to position .
- ▶ Push temperature control ⑤ fully up.

### Rear window defroster

The rear window defroster serves to de-ice the rear window quickly and clear the view if the rear window is fogged.

The rear window defroster uses a large amount of power. To keep battery drain to a minimum, switch off the rear window defroster as soon as the rear window is clear. The rear window defroster is automatically deactivated after approximately 10 minutes of operation.

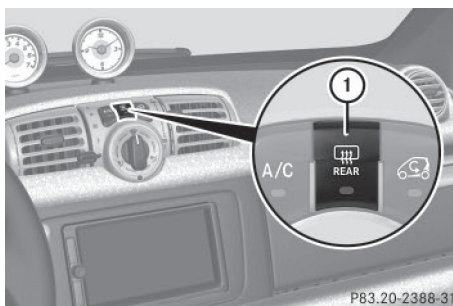

- ▶ Make sure the key is in starter switch position 1.
- ▶ **Switching on:** Press rear window defroster switch ①. The indicator lamp in rear window defroster switch ① comes on.
- ▶ **Switching off:** Press rear window defroster switch ① once more. The indicator lamp in rear window defroster switch ① goes out.

**Air recirculation mode\***

Switch to air recirculation mode<sup>12</sup> to prevent unpleasant odors from entering the vehicle from the outside (e.g. before driving through a tunnel). This setting cuts off the intake of outside air and recirculates the air in the passenger compartment.

**⚠ WARNING**

When the air recirculation mode is switched on, windows can fog on the inside immediately. Fogged windows impair visibility, endangering you and others. If the windows begin to fog on the inside, switching off the air recirculation mode immediately should clear interior window fogging. If interior window fogging persists, make sure the air conditioning is switched on, turn air distribution control ⑥ to position  and increase the air volume using air volume control ①.

Control panel (> page 103).

► **Switching on:** Press air recirculation switch ④.

The indicator lamp in air recirculation switch ④ comes on.

► **Switching off:** Press air recirculation switch ④ once more.

The indicator lamp in air recirculation switch ④ goes out.

**Loading and storing****Cup holder****⚠ WARNING**

In order to help prevent spilling liquids on vehicle occupants and/or vehicle equipment, only use containers that fit into the cup holder. Use lids on open containers and do not fill containers to a height where the contents, especially hot liquids, could spill during braking, vehicle maneuvers,

or an accident. Liquids spilled on vehicle occupants may cause serious personal injury. Liquids spilled on vehicle equipment may cause damage not covered by the smart Limited Warranty.

Keep in mind that objects placed in a cup holder may come loose during braking, vehicle maneuvers, or an accident and be thrown around in the vehicle interior. Objects thrown around in the vehicle interior may cause an accident and/or serious personal injury.

The cup holder can be used to safely store sealed drink bottles, containers with a lid, or beverage cans.

❗ Do not use the cup holder as an ashtray. Otherwise it could be damaged.

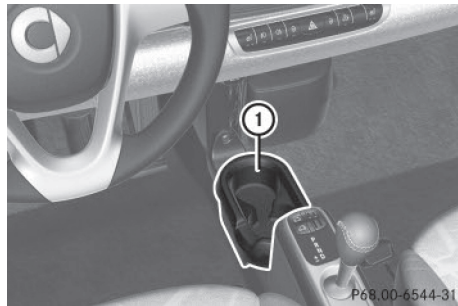

You can store two cups, drink bottles or beverage cans in cup holder ①.

i Clean the cup holder with a damp cloth.

**Cargo compartment cover blind with parcel net bag**

This feature is only available in Canada for the model passion.

**⚠ WARNING**

The cargo compartment cover blind is not intended to secure heavy objects in the event of an accident. For this reason, heavy objects must be tied down.

<sup>12</sup> Vehicles with air conditioning with climate control\* only.

\* optional

Vehicle occupants could be injured by objects being thrown around in the vehicle in the event of

- hard braking
- a change of direction
- an accident

**⚠ WARNING**

Do not place any objects on the mounted cargo compartment cover blind.

Vehicle occupants could be injured by objects being thrown around in the vehicle in the event of

- hard braking
- a change of direction
- an accident

**⚠ WARNING**

Only place light loads in the parcel net bag. Do not transport heavy, sharp-edged or fragile objects in the parcel net bag. The parcel net bag cannot sufficiently secure loads in an accident.

Vehicle occupants could be injured by objects being thrown around in the vehicle in the event of

- hard braking
- a change of direction
- an accident

Observe the loading guidelines.

The cargo compartment cover blind

- serves to protect objects that are stored in the vehicle's cargo compartment from prying eyes
- prevents smaller objects from penetrating into the passenger compartment from the cargo compartment; however, it is not intended to act as a load restraining device

The parcel net bag

- is for storing small, lightweight objects
- prevents small objects from sliding around inside the passenger compartment

**!** If objects are placed on the cargo compartment cover blind when mounted, the cover may be damaged.

### Fitting

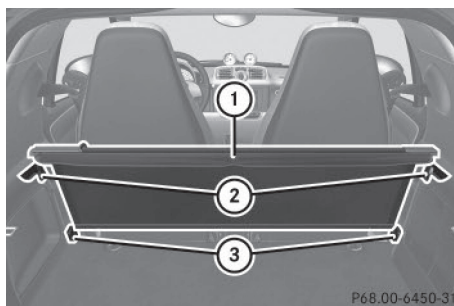

If you wish to use cargo compartment cover blind ① as normal, assemble it in top mountings ②. If you do not need the cargo compartment cover blind, insert in bottom mountings ③.

- ▶ Open the tailgate.
- ▶ Secure cargo compartment cover blind ① at the front of the cargo compartment with the parcel net bag.
- ▶ Insert cargo compartment cover blind ① on the right-hand side in top mounting ② or in bottom mounting ③.

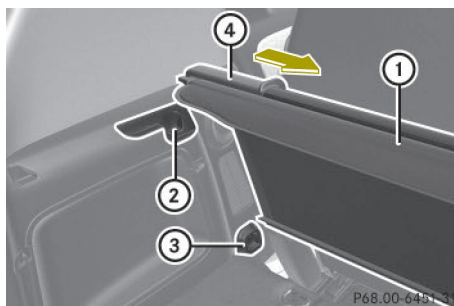

- ▶ Push handle ④ to the right in the direction of the arrow.
- ▶ Insert cargo compartment cover blind ① in top mounting ② or bottom mounting ③ in the left-hand side paneling and release handle ④.
- ▶ Cargo compartment cover blind ① engages.

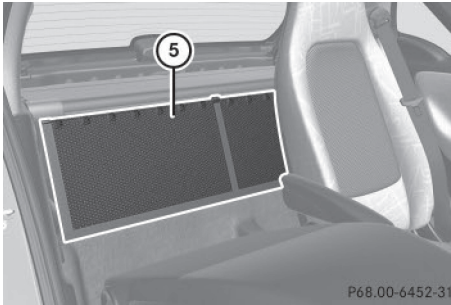

P68.00-6452-31

- ▶ Pull parcel net bag ⑤ down slightly and secure with the hook and loop fastener.
- ▶ Remove in reverse order.

### Controls

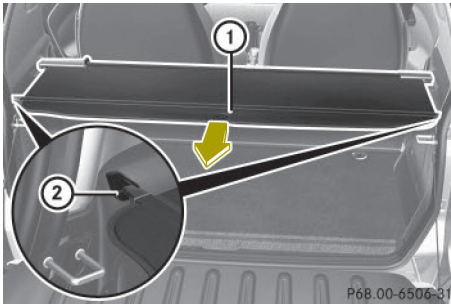

P68.00-6506-31

- ▶ **Closing:** Take hold of cargo compartment cover blind ① in the middle and pull backwards.
- ▶ Guide cargo compartment cover blind ① into the rear right and left mountings ②.
- ▶ **Opening:** Take hold of cargo compartment cover blind ① in the middle, pull back-

wards, and remove from rear mountings ②.

- ▶ Guide cargo compartment cover blind ① into position.

### Coat hooks

The coat hooks are located at the rear roof rail on the driver's and passenger side.

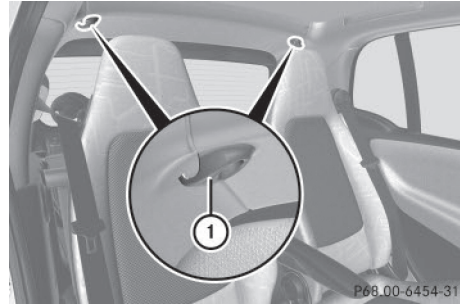

P68.00-6454-31

Coat hook on driver's side

- ① Coat hook

### Storage compartments

#### ⚠ WARNING

To help avoid personal injury during a collision or sudden maneuver, exercise care when storing objects in the vehicle. Put luggage or cargo in the cargo compartment if possible. Do not pile luggage or cargo higher than the seat backrests.

Keep compartment lids closed. This will help to prevent stored objects from being thrown about and injuring vehicle occupants during

- hard braking
- a change of direction
- an accident

Do not store objects under the driver's seat. Objects stored under the driver's seat can slide forward into driver's foot well during braking and get caught between or beneath the pedals. This could restrict your ability

to brake or accelerate and could lead to accidents and injury.

### Coin holder

The coin holder is located in front of the gear selector lever.

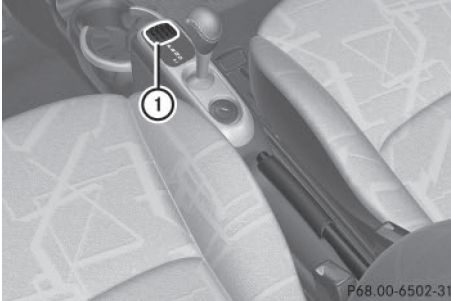

Example illustration (coupé)

① Coin holder

### Door pockets

The door pockets are located in the driver's and passenger door.



① Door pocket

### Storage trays next to the steering wheel

The storage trays are located to the left and right of the steering wheel.

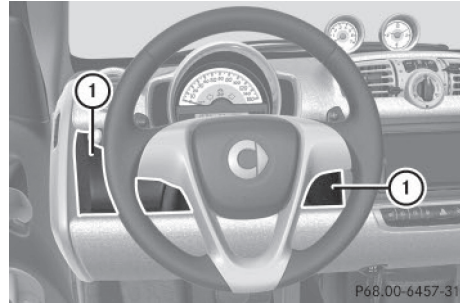

① Storage tray

### Glove box

**i** A clamp rail for slips of paper is located on the outside of the glove box lid.

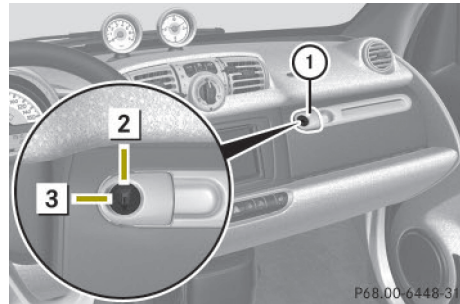

- ▶ **Opening:** Pull on glove box lid release ① and fold down the glove box lid.
- ▶ **Closing:** Lift up the glove box lid with a bit of force until it engages.
- ▶ **Locking:** Insert the key into the glove box lock and turn it to position ③.
- ▶ **Unlocking:** Insert the key into the glove box lock and turn it to position ②.



### Storage tray\* in center console

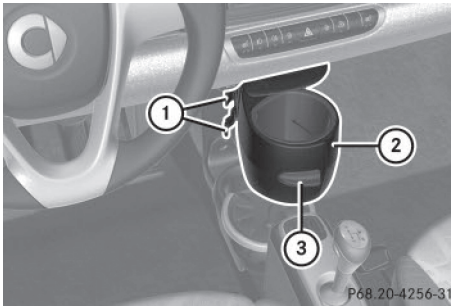

- ▶ **Installing:** Slide storage tray ② onto the cones on the center console until it engages audibly.
- ▶ **Removing:** Press levers ① simultaneously towards the storage tray.
- ▶ Pull storage tray ② away from the center console.
- ▶ **Opening:** Pull handle ③.
- ▶ **Closing:** Swivel storage tray ② back until it engages.

### Parcel nets

Parcel nets are located on the in-board sides of the seat backrests.

- ❗ Vehicles equipped with an armrest\* on the driver's seat, have a parcel net on the passenger seat only.
- ❗ Each parcel net is intended for light-weight items of below 0.9 lb (0.4 kg).

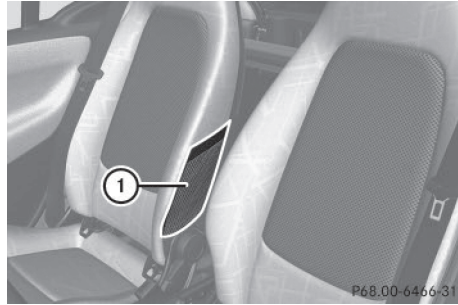

Example illustration: Parcel net on passenger seat

- ① Parcel net

### Drawer\*

A drawer is located below the audio system\*<sup>13</sup>.

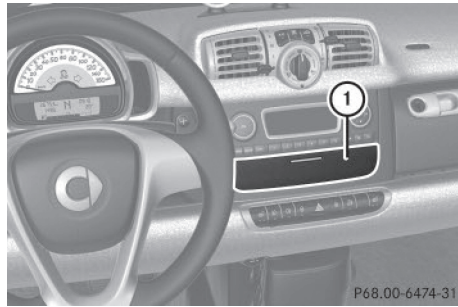

- ▶ **Opening:** Press on the center of drawer ①. The drawer opens slightly.
- ▶ Pull drawer ① to open completely.
- ▶ **Closing:** Press on drawer ① until it engages.

### Storage compartment in the tailgate (coupé only)

You can store small objects in the storage compartment in the tailgate.

<sup>13</sup> Vehicles with audio system basic\* only.

\* optional

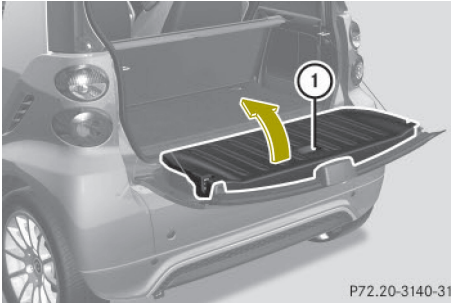

- ▶ **Opening:** Open the tailgates.
- ▶ Pull handle ① on the inside of the tailgate backward.
- ▶ Lift up the storage compartment cover.
- ▶ **Closing:** Close storage compartment cover ①.
- ▶ Press on the "PRESS" marking in the middle of storage compartment cover ① until it engages audibly.
- ▶ Close the tailgates (▷ page 55).

### Loading instructions

#### **WARNING**

Transport heavy or hard objects in the cargo compartment, not in the passenger compartment.

Always fasten items being carried as securely as possible using fastening materials appropriate for the weight and size of the load.

In an accident, during hard braking or sudden maneuvers, loose items may be thrown around inside the vehicle, causing injury to vehicle occupants.

#### **WARNING**

To help avoid personal injury during a collision or sudden maneuver, exercise care when storing objects in the vehicle. Put luggage or cargo in the cargo compartment if possible. Do not pile luggage or cargo higher than the seat backrests.

Keep compartment lids closed. This will help to prevent stored objects from being thrown about and injuring vehicle occupants during

- braking
- vehicle maneuvers
- an accident

#### **WARNING**

No racks or loads may be secured to the roof of the vehicle, as

- the panorama roof\* may be damaged, thus injuring persons
- this can have a substantial adverse effect on the driving dynamics of the vehicle, thus causing accidents
- the rack and/or the load could detach and through this cause an accident or other people could be injured by the load and/or rack that has fallen off

#### **WARNING**

Make sure the tailgate is closed when the engine is running and while driving. Among other dangers, deadly carbon monoxide (CO) gases may enter vehicle interior resulting in unconsciousness and death.

#### **WARNING**

Do not store any flammable substances inside the vehicle that could ignite and start a fire.

#### **WARNING**

The manufacturer has not approved your vehicle for towing a trailer. A trailer can permanently impair driving safety.

The gross vehicle weight which is the weight of the vehicle including fuel, tools, installed accessories, passengers, and luggage/cargo must never exceed the load limit and the Gross Vehicle Weight Rating (GVWR) for your vehicle as specified on the placard located on the driver's door B-pillar (▷ page 214). In addition, the load must

\* optional

be distributed in such a way so that the weight on each axle never exceeds the Gross Axle Weight Rating (GAWR) for the front and rear axle. The GVWR and GAWR for your vehicle are indicated on the certification label which can be found on the driver's door B-pillar.

For more information, see "Loading the vehicle" (> page 130).

The handling characteristics of a fully loaded vehicle depend greatly on the load distribution. It is therefore recommended to load the vehicle with the heaviest items being placed towards the front of the vehicle.

Please pay attention to and comply with the following instructions when loading the vehicle and transporting cargo:

- Always place items being carried against seat backrests, and fasten them as securely as possible.
- The heaviest portion of the cargo should always be kept as low as possible against seat backrests.
- Do not stack loads higher than the top edge of the head restraints.
- Make sure no luggage/cargo items can get above or next to the driver's and/or passenger seat into the passenger compartment.
- Make sure luggage/cargo is properly secured.
- Always use, if so equipped, cargo net\* when transporting cargo.

Do not carry any unnecessary weight in the vehicle. This increases vehicle weight, which results in increased energy consumption.

## Useful features

### Sun visors

The sun visors protect you from sun glare while driving.

\* optional

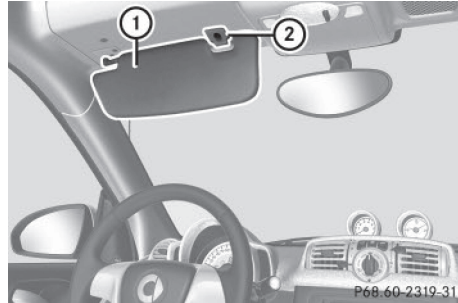

### Glare through the windshield

- ▶ Swing sun visor ① down.

### Glare through a side window

- ▶ Swing sun visor ① down.
- ▶ Disengage sun visor ① from mounting ②.
- ▶ Pivot sun visor ① to the side.

### Sun screen\*

The sun screen provides protection from sun rays and from heat generated by the panorama roof\*.

The sun screen can be adjusted to any desired position.

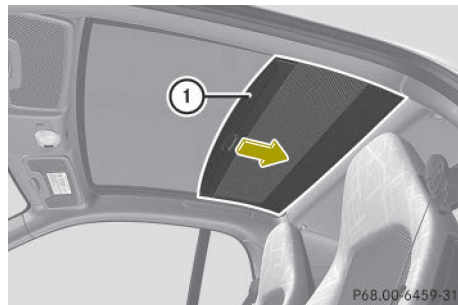

- ▶ **Opening or closing:** Move sun screen ① forward or backward using the handle.

### Auxiliary power outlet

The auxiliary power outlet supplies power to the following electrical accessories when the key is turned to starter switch position 1:

- the cigarette lighter\*, available in conjunction with the ashtray\*
- the electric air pump, available in conjunction with the tire repair kit\*
- other consumers which operate up to a maximum of 60 W

**!** The auxiliary power outlet can accommodate 12V DC electrical accessories designed for use with the standard “cigarette lighter” plug type.

Keep in mind, however, that connecting accessories to the auxiliary power outlet (for example extensive connecting and disconnecting, or using plugs that do not fit properly) can damage the auxiliary power outlet. With the auxiliary power outlet damaged, the cigarette lighter\* may no longer be able to be placed in the heating (pushed-in) position, or may pop out before it is hot enough.

The auxiliary power outlet is located in the lower center console.

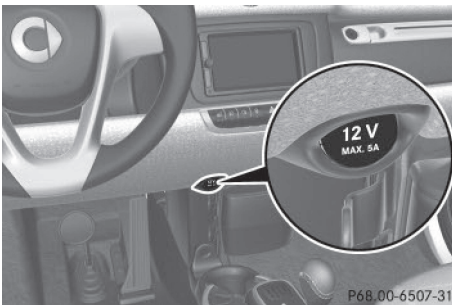

Auxiliary power outlet

- Turn the key to starter switch position 1.

**!** Please observe the safety instructions given in the respective operating instructions.

Please note that

- if using the auxiliary power outlet the maximum current drawn may not exceed 5 A or 60 W
- the electric air pump\* can be connected to the auxiliary power outlet for the time it takes to inflate the tire without any problem
- the vehicle battery will discharge when current is drawn.

\* optional



The first 1000 miles (1500 km) .....	116
At the gas station .....	116
Engine compartment .....	117
Front compartment .....	120
Tires and wheels .....	124
Winter driving .....	143
Driving instructions .....	144
Driving abroad .....	151
Vehicle care .....	151

**>> Operation.**

### The first 1000 miles (1500 km)

In the Operation section you will find detailed information on operating, maintaining and caring for your vehicle.

The more cautiously you treat your vehicle during the break-in period, the more satisfied you will be with its performance later on.

- Drive your vehicle during the first 1000 miles (1500 km) at varying but moderate vehicle and engine speeds.
- During this period, avoid heavy loads (full throttle driving) and excessive engine speeds (no more than  $\frac{2}{3}$  of maximum rpm in each gear).
- Shift gears in a timely manner.
- Do not attempt to slow the vehicle down by shifting to a lower gear.
- Avoid accelerating by kickdown.

After 1000 miles (1500 km), you may gradually increase vehicle and engine speeds to the permissible maximum.

All of the above instructions also apply when driving the first 1000 miles (1500 km) after the engine has been replaced.

- ① Always obey applicable speed limits.

### At the gas station

#### Refueling

#### WARNING

Gasoline is highly flammable and poisonous. It burns violently and can cause serious personal injury.

Never allow sparks, flame or smoking materials near gasoline!

Turn off the engine before refueling.

Whenever you are around gasoline, avoid inhaling fumes and skin or clothing contact. Extinguish all smoking materials.

Direct skin contact with fuels and the inhalation of fuel vapors are damaging to your health.

- ❗ Do not put diesel fuel in vehicles with gasoline engines. Do not mix gasoline with diesel fuel. Even small quantities of diesel fuel will damage the injection system. Damage caused by adding diesel fuel will not be covered by the smart Limited Warranty.

If diesel fuel has mixed with gasoline, do not start the engine. Otherwise the catalytic converter will be irreparably damaged.

Contact an authorized smart center or Roadside Assistance immediately and have the vehicle towed.

- ❗ Damage resulting from mixing gasoline with diesel fuel is not covered by the smart Limited Warranty.

The fuel filler flap is located on the passenger side towards the rear. Locking/unlocking the vehicle with the key automatically locks/unlocks the fuel filler flap.

- ① In case the central locking system does not release the fuel filler flap, or the opening mechanisms is clamping, contact Roadside Assistance or an authorized smart center.

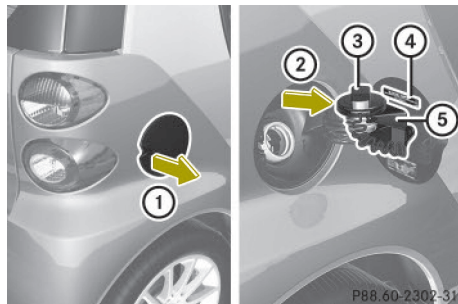

- ① Opening the fuel filler flap
- ② Inserting the fuel filler cap
- ③ Fuel filler cap

- ④ Fuel type label
- ⑤ Holder
- ▶ Turn off the engine.
- ▶ Remove the key from the starter switch.
- ▶ Open the fuel filler flap by pulling at the point indicated by arrow ①.
- ▶ Turn fuel filler cap ③ counterclockwise and hold on to it until possible pressure is released.
- ▶ Take off fuel filler cap ③.

**!** The fuel filler cap is tethered to the fuel filler flap. Do not drop the fuel filler cap. It could damage the vehicle paint finish.

- ▶ Insert fuel filler cap ③ in direction of arrow ② into holder ⑤ on the inside of the fuel filler flap.
- ▶ Fully insert filler nozzle unit and refuel.
- ▶ Only fill your tank until the filler nozzle unit cuts out – **do not top off or overfill.**

**⚠ WARNING**

Overfilling of the fuel tank may create pressure in the system which could cause a gas discharge. This could cause the gas to spray back out when removing the fuel pump nozzle, which could cause personal injury.

- ▶ Replace fuel filler cap ③.
- ▶ Turn fuel filler cap ③ clockwise until the handle grip overturns.
- i** Make sure to close the fuel filler flap before locking the vehicle as the fuel filler flap locking pin prevents closing after you have locked the vehicle.
- ▶ Close the fuel filler flap.  
You should hear the latch close shut.
- i** Only use premium unleaded gasoline with a minimum Posted Octane Rating of 91 (average of 96 RON/86 MON). Information on gasoline quality can normally be found on the fuel pump. Please contact

gas station personnel in case labels on the pump cannot be found.

For more information on gasoline, see “Premium unleaded gasoline” (▷ page 221) and “Fuel requirements” (▷ page 221), or contact an authorized smart center.

**Check regularly and before a long trip**

For information on quantities and requirements of operating agents, see “Service fluids and capacities” (▷ page 218).

Check the following:

- Engine oil level (▷ page 118)
- Tire inflation pressure (▷ page 127)
- Coolant level (▷ page 122)
- Vehicle lighting (▷ page 178)
- Windshield washer system (▷ page 123)
- Brake fluid (▷ page 123)

**>> Operation.**

**Engine compartment**

**Engine compartment cover**

Open the engine compartment cover to check the engine oil level and if necessary, to add engine oil.

**⚠ WARNING**

High outside temperature, stop-and-go traffic, driving on long uphill grades or driving at high engine speed may increase the temperature in the engine compartment. Therefore, the engine compartment cover and parts in the area around the engine compartment cover may be hot. Parts of the engine can become very hot. To prevent burns, let the engine cool off completely before touching the engine compartment cover, parts in the area around the engine compartment cover, and parts of the engine.

- ▶ Engage the parking brake.
- ▶ Move the gear selector lever to park position **P**.
- ▶ Switch off the ignition.
- ▶ Open the tailgate.

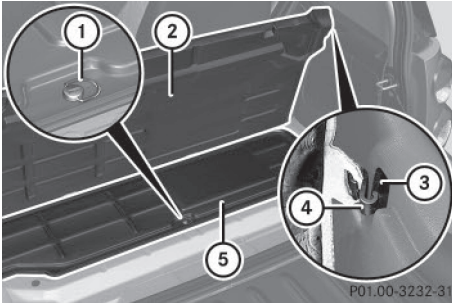

>> Operation.

#### WARNING

Exercise extreme caution if you see flames or smoke coming from the engine compartment. Move away from the vehicle and call the fire department.

If the coolant temperature warning lamp indicates that the engine is overheated, do not attempt to open the engine compartment cover. Move away from the vehicle and wait until the engine has cooled before opening the engine compartment.

#### WARNING

To help prevent personal injury, stay clear of moving parts when the engine compartment cover is open and the engine is running.

#### WARNING

The engine is equipped with a transistorized ignition system that utilizes high voltage. Do not touch any components (ignition coils, spark plug sockets, diagnostic socket) of the ignition system

- while the engine is running
- while starting the engine
- if ignition is "on" and the engine is turned manually

- ▶ **Opening:** Grasp the strap on cargo compartment floor ②.
- ▶ Lift cargo compartment floor ② with the strap.
- ▶ Engage hook ④ into top mounting ③ of cargo compartment cover blind ⑤.
- ▶ Remove fastening screw ①.
- ▶ Remove engine compartment cover ⑤.
- ▶ **Closing:** Slide engine compartment cover ⑤ forward into the tabs provided.
- ▶ Tighten fastening screw ①.
- ▶ Disengage hook ④ from top mounting ③.
- ▶ Fold cargo compartment floor ② back down.
- ▶ Push the right hand and left hand cargo compartment floor edges under the edges of the side panels.
- ▶ Close the tailgate.

### Engine oil

The amount of oil your engine needs will depend on a number of factors, including driving style. Increased oil consumption can occur when the vehicle is new or the vehicle is driven at higher engine speeds frequently.

Engine oil consumption checks should only be made after the vehicle break-in period.

 Do not use any special lubricant additives, as these may increase wear and damage the drive assemblies. Using special additives not approved by smart may cause damage not covered by the smart Limited Warranty. More information on this subject is available at any smart center.

### Checking engine oil level

 Check the engine oil level at regular intervals.



When checking the engine oil level

- the vehicle must be parked on level ground
- the vehicle must have been stationary for at least five minutes with the engine turned off
- ▶ Turn off the engine.
- ▶ Engage the parking brake.
- ▶ Open the tailgate.
- ▶ Open the engine compartment cover (> page 117).

The oil dipstick is located in the engine compartment on the passenger side.

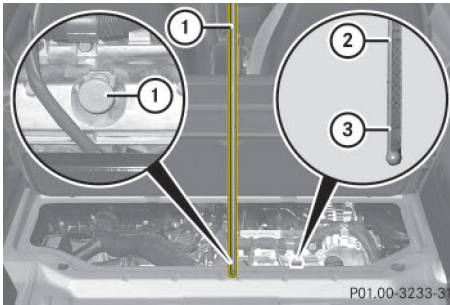

- ▶ Pull out oil dipstick ①.
- ▶ Wipe oil dipstick ① clean with a clean cloth.
- ▶ Fully insert oil dipstick ① into the dipstick guide tube.
- ▶ Pull out oil dipstick ① again after approximately one minute to obtain accurate reading.

The oil level is correct when it is between lower mark ③ (minimum) and upper mark ② (maximum) on both sides of oil dipstick ①.

- ▶ Fully insert oil dipstick ① into the dipstick guide tube again.
- ▶ If necessary, add engine oil (> page 119).

**i** The filling quantity between the upper and lower marks on the oil dipstick is approximately 1.1 US qt (1.0 l).

### Adding engine oil

**!** Only use approved engine oils and oil filters required for vehicles with Maintenance System. For a listing of approved engine oils and oil filters contact an authorized smart center.

Using engine oils and oil filters of specification other than those expressly required for the Maintenance System, or changing of oil and oil filter at change intervals longer than those called for by the Maintenance System will result in engine or emission control system damage not covered by the smart Limited Warranty.

#### **⚠ WARNING**

When adding engine oil, always use a funnel to avoid spilling oil on any hot parts such as the catalytic converter or exhaust system.

If this should happen, however, the engine must be thoroughly cleaned before you continue your trip. The engine oil could otherwise ignite.

The filler cap is located in the engine compartment on the passenger side.

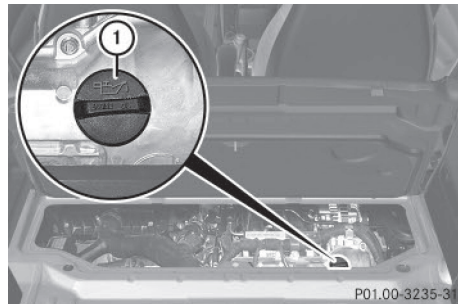

- ▶ Unscrew filler cap ① from the filler neck.
- ▶ Add engine oil as required.  
Do not add more than 0.53 US qt (0.5 l) engine oil at a time.
- ▶ Wait one minute until the engine oil has run into the oil pan.

- ▶ Check the engine oil level once more.
  - ▶ Add engine oil once more if necessary.
- Be careful not to spill any oil when adding to avoid environmental damage caused by oil entering the ground and water.

**!** Excess engine oil must be siphoned or drained off. It could cause damage to the engine or emission control system not covered by the smart Limited Warranty.

- ▶ Screw filler cap ① back on the filler neck.
- ▶ Close the engine compartment cover (▷ page 117).

### Front compartment

#### Service flap

Remove the service flap to check the coolant level, windshield washer reservoir level, and brake fluid level.

Insert the service flap on the front of the vehicle so that it does not get damaged or dirty.

- i** The service flap has a strap on the rear side that ties it to the vehicle body.

#### **!** WARNING

Always turn the key to starter switch position **0** and remove the key from the starter switch before opening the service flap.

If the windshield wipers should inadvertently be switched on, you could be seriously injured by the wiper washer drive, which is located just below the service flap.

#### **!** WARNING

Make sure the service flap is locked while driving. Otherwise, the service flap could become detached and pose a hazard to you or others.

#### **!** WARNING

To help prevent personal injury, stay clear of moving parts when the service flap is open.

The radiator fan may continue to run for approximately 30 seconds or may even restart after the engine has been turned off. Stay clear of fan blades.

- !** Check the fill levels at regular intervals.
- !** Carefully remove ice, snow, and any other deposits from the air intake grilles above the service flap to ensure air intake at all times.
- ▶ Park the vehicle on level ground.
- ▶ Turn off the engine.
- ▶ Engage the parking brake.

### Removing

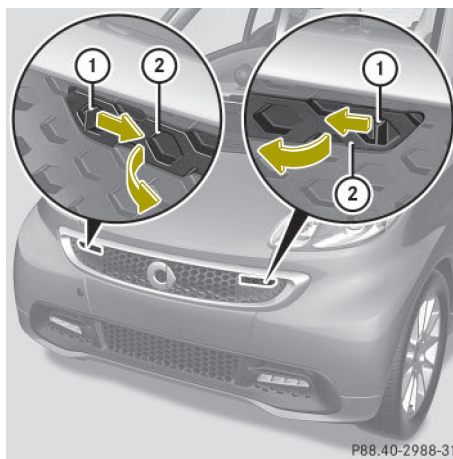

P88.40-2988-31

- ▶ Using a suitable object, push both openers ① towards the inside in direction of the arrows.
- ▶ Both levers ② are released from the radiator grille.
- ▶ Pull both levers ② forward in direction of the arrows.



P88.40-2983-31

- ▶ Pull both levers (2) fully towards the outside in the direction of the arrows.
- ▶ Lift the front of service flap (3).
- ▶ First pull service flap (3) forward slightly and then remove it upwards as indicated by arrow (4).

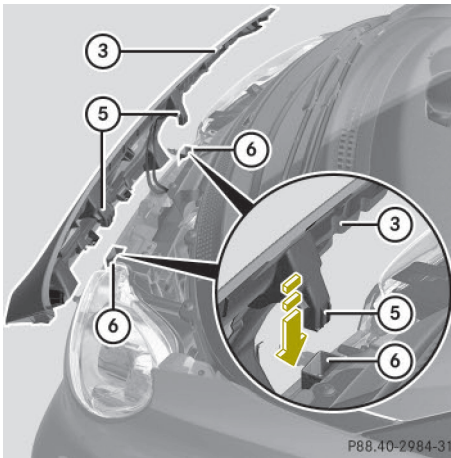

P88.40-2984-31

- ▶ Insert hooks (5) on the back of service flap (3) into openings (6).

**Remounting**

- ▶ Lift service flap (3) out of openings (6).

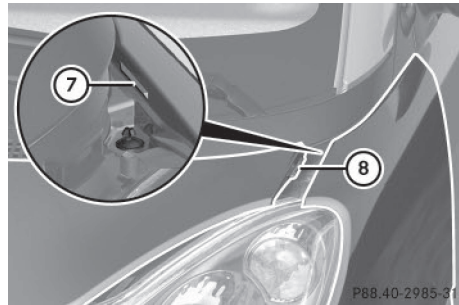

P88.40-2985-31

- ▶ Insert left and right links (8) of service flap (3) under links (7) on the fender.

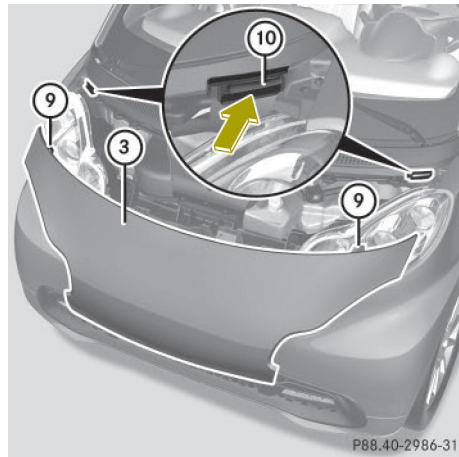

P88.40-2986-31

- ▶ Insert both tabs (9) on the back of service flap (3) completely into openings (10).

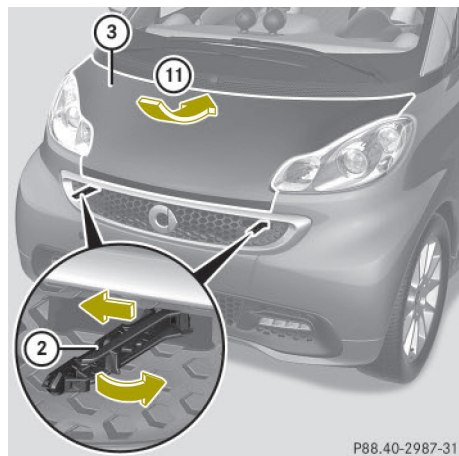

P88.40-2987-31

>> Operation.

- ▶ Push service flap ③ down in direction of arrow ⑪.
- ▶ First push both levers ② inward and then to the rear.



P88.40-2993-31

>> Operation.

- ▶ Press both levers ② into the radiator grille until they engage.

### Coolant

#### ⚠ WARNING

In order to avoid potentially serious burns:

- Use extreme caution when opening the service flap if there are any signs of steam or coolant leaking from the cooling system, or if the coolant temperature warning lamp  in the instrument cluster indicates that the coolant is overheated.
- Do not remove the pressure cap on coolant reservoir if coolant temperature is above 158°F (70°C). Allow engine to cool down before removing cap. The coolant reservoir contains hot fluid and is under pressure.
- Using a rag, slowly turn the cap approximately 1/2 turn to relieve excess pressure. If opened immediately, scalding hot fluid and steam will be blown out under pressure.

The engine coolant is a mixture of water and anticorrosion/antifreeze. To check the coolant level the vehicle must be parked on level ground and the engine must have cooled down. For more information, see "Coolants" (▷ page 223).

### Checking coolant level

- ▶ Remove the service flap and insert it on the front of the vehicle (▷ page 120).

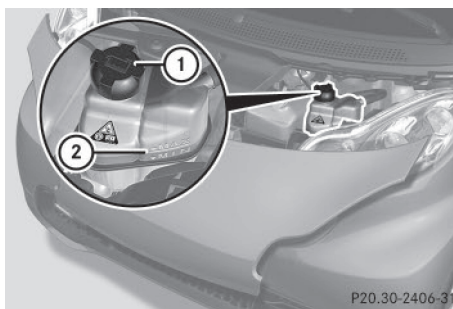

P20.30-2406-31

The coolant reservoir is located in the front compartment on the driver's side.

- ▶ Allow the radiator to cool down for at least 30 minutes.
- ▶ Using a rag, slowly turn pressure cap ① approximately 1/2 turn counterclockwise to release any excess pressure.
- ▶ Continue turning pressure cap ① counterclockwise and remove it.

The coolant level is correct if the level

- for cold coolant: reaches marking bar ② visible through the filling opening
- for warm coolant: is approximately 0.6 in (1.5 cm) higher
- ▶ If necessary, add coolant.

### Adding coolant

- ▶ Add coolant as required. The coolant level may not exceed the maximum filling level.
- ▶ Replace and tighten pressure cap ①.
- ▶ Remount the service flap and close it (▷ page 120).

### Windshield/rear window washer system

Both the windshield and the rear window<sup>14</sup> washer are supplied from the windshield washer reservoir.

The recommended minimum filling level is 1.06 US qt (1.0 l).

- ▶ Remove the service flap and insert it on the front of the vehicle (▷ page 120).

The windshield washer reservoir is located in the front compartment on the driver's side.

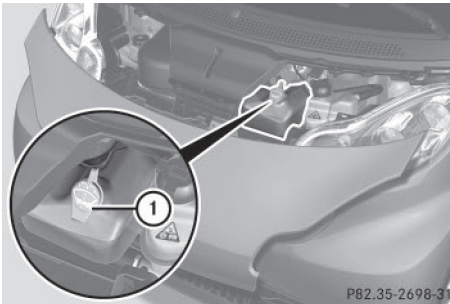

#### **⚠ WARNING**

Windshield washer concentrate is highly flammable. Fire, naked flames and smoking are prohibited when windshield washer concentrate is being handled.

- ▶ Use a windshield washer concentrate labeled for summer and water for temperatures above freezing point.
- ▶ Use a windshield washer concentrate labeled for winter and water for temperatures below freezing point.

- ❗ Always use a windshield washer concentrate labeled for winter where temperatures may fall below freezing point. Failure to do so could result in damage to the washer system/reservoir.

- ▶ Premix the windshield washer fluid in a suitable container. Observe mixing ratios depending on the outside temperature (▷ page 222).
- ▶ Use the tab to pull cap ① upwards.
- ▶ Refill the windshield washer reservoir.
- ▶ Push cap ① onto the windshield washer reservoir.
- ▶ Remount the service flap and close it (▷ page 120).

### Brake fluid

#### **⚠ WARNING**

During vehicle operation, the boiling point of the brake fluid is continuously reduced through the absorption of moisture from the atmosphere. Under extremely strenuous operating conditions, this moisture content can lead to the formation of bubbles in the system, thus reducing the system's efficiency.

Therefore, the brake fluid must be replaced regularly. Refer to your vehicle's Maintenance Booklet for replacement interval.

The brake fluid level in the brake fluid reservoir may be too low if the brake warning lamp in the instrument cluster comes on (▷ page 21) although the parking brake is released.

- ❗ If you find that the brake fluid in the brake fluid reservoir has fallen to the minimum mark or below, have the brake system checked for brake pad thickness and leaks immediately. Contact an authorized smart center immediately. Do

<sup>14</sup> Coupé only.

not add brake fluid as this will not solve the problem.

- ▶ Remove the service flap and insert it on the front of the vehicle (> page 120).

The brake fluid reservoir is located in the front compartment on the passenger side.

>> Operation.

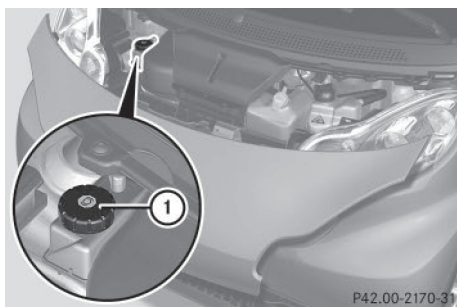

### Checking brake fluid level

- ▶ Perform a visual check of the brake fluid reservoir ①.

The brake fluid level is correct when it is between the minimum mark and the maximum mark.

- If the brake fluid level has fallen slightly below the minimum mark, drive to an authorized smart center.
  - If the brake fluid level has fallen significantly below the minimum mark, call Roadside Assistance or an authorized smart center.
- ▶ Remount the service flap and close it (> page 120).

### Tires and wheels

#### Safety notes

Contact an authorized smart center for information on tested and recommended rims and tires for summer and winter operation. They can also offer advice concerning tire service and purchase.

#### ⚠ WARNING

Replace rims or tires with the same designation, manufacturer and type as shown on the original part. For further information contact an authorized smart center. If incorrectly sized rims and tires are mounted, the wheel brakes or suspension components can be damaged. Also, the operating clearance of the wheels and the tires may no longer be correct.

#### ⚠ WARNING

Worn, old tires can cause accidents. If the tire tread is worn to minimum tread depth, or if the tires have sustained damage, replace them.

When replacing rims, only use genuine smart wheel bolts specified for the particular rim type. Failure to do so can result in the bolts loosening and possibly an accident.

Retreaded tires are not tested or recommended by smart, since previous damage cannot always be recognized on retreads. The operating safety of the vehicle cannot be assured when such tires are used.

#### ⚠ WARNING

If you feel a sudden significant vibration or ride disturbance, or you suspect that possible damage to your vehicle has occurred, you should turn on the hazard warning flashers, carefully slow down, and drive with caution to an area which is a safe distance from the road.

Inspect the tires and the vehicle underbody for possible damage. If the vehicle or tires appear unsafe, have the vehicle towed to the nearest authorized smart center or tire dealer for repairs.

#### ⚠ WARNING

Do not drive with a flat tire. A flat tire affects the ability to steer or brake the vehicle. You could lose control of the vehicle. Continued driving with a flat tire or

driving at high speed with a flat tire will cause excessive heat build-up and possibly a fire.

Modifications to the brake system and wheels and the use of brake dust rings are not permissible.

### Important guidelines

- Only use sets of tires and rims of the same type and make.
- Tires must be of the correct size for the rim.
- Break in new tires for approximately 60 miles (100 km) at moderate speeds.
- Regularly check the tires and rims for damage. Dented or bent rims can cause tire pressure loss and damage to the tire beads.
- If vehicle is heavily loaded, check tire inflation pressure and correct as required.
- Do not allow your tires to wear down too far. Adhesion properties on wet roads are sharply reduced at tread depths of less than  $\frac{1}{8}$  in (3 mm).

### Recommended tire inflation pressure

#### WARNING

Follow recommended tire inflation pressures.

Do not underinflate tires. Underinflated tires wear excessively and/or unevenly, adversely affect handling and fuel economy, and are more likely to fail from being overheated.

Do not overinflate tires. Overinflated tires can adversely affect handling and ride comfort, wear unevenly, increase stopping distance, and result in sudden deflation (blowout) because they are more likely to become punctured or damaged by road debris, potholes etc.

Do not overload the tires by exceeding the specified load limit as indicated on the Tire and Loading Information placard on the driver's door B-pillar. Overloading the tires can overheat them, possibly causing a blowout. Overloading the tires can also result in handling or steering problems, or brake failure.

Your vehicle is equipped with the Tire and Loading Information placard located on the driver's door B-pillar (> page 130).

The tire inflation pressure should be checked regularly. Only adjust the tire inflation pressure on cold tires. The tires can be considered cold if the vehicle has been parked for at least 3 hours or driven less than 1 mile (1.6 km). Depending on the ambient temperature, the driving speed and the tire load, the tire temperature changes. When the tire temperature changes by 18°F (10°C), the tire inflation pressure will change by approximately 10 kpa (0.1 bar, 1.5 psi). Keep this in mind when checking tire inflation pressure on warm tires and adjust the tire pressure only if the tire inflation pressure is too low for the current operating conditions. If you check the tire inflation pressure when the tires are warm, the reading will be higher than the cold reading. This is normal. Do not let air out to match the specified cold tire inflation pressure. Otherwise, the tire will be underinflated.

Follow recommended cold tire inflation pressures listed on Tire and Loading Information placard on the driver's door B-pillar.

Keeping the tires properly inflated provides the best handling, tread life and riding comfort.

In addition to the Tire and Loading Information placard on the driver's door B-pillar, also consult the tire inflation pressure label (if available) on the inside of the filler flap for any additional information pertaining to special driving situa-

tions. For more information, see “Important notes on tire inflation pressure” (▷ page 126).

**i** Data shown on Tire and Loading Information placard example are for illustration purposes only. Tire data are specific to each vehicle and may vary from data shown in the following illustration. Refer to Tire and Loading Information placard on vehicle for actual data specific to your vehicle.

>> Operation.

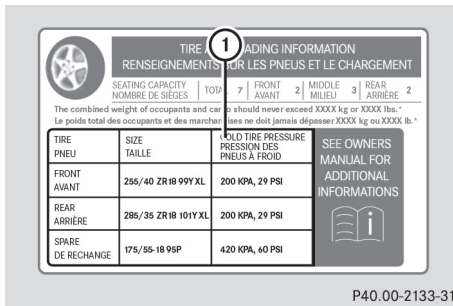

P40.00-2133-31

The Tire and Loading Information placard lists the recommended cold tire inflation pressures **1** for maximum loaded vehicle weight. The tire inflation pressures listed apply to the tires installed as original equipment.

### Important notes on tire inflation pressure

#### **! WARNING**

If the tire inflation pressure drops repeatedly, check the tires for punctures from foreign objects and/or whether air is leaking from the valves or from around the rim.

Tire temperature and tire inflation pressure are also increased while driving, depending on the driving speed and the tire load.

### Potential problems associated with underinflated and overinflated tires

#### Underinflated tires

##### **! WARNING**

Follow recommended tire inflation pressures.

Do not underinflate tires. Underinflated tires wear excessively and/or unevenly, adversely affect handling and fuel economy, and are more likely to fail from being overheated.

Underinflated tires can

- cause excessive and uneven tire wear
- adversely affect fuel economy
- lead to tire failure from being overheated
- adversely affect handling characteristics

#### Overinflated tires

##### **! WARNING**

Follow recommended tire inflation pressures.

Do not overinflate tires. Overinflated tires can adversely affect handling and ride comfort, wear unevenly, increase stopping distance, and result in sudden deflation (blowout) because they are more likely to become punctured or damaged by road debris, potholes etc.

Overinflated tires can

- adversely affect handling characteristics
- cause uneven tire wear
- be more prone to damage from road hazards
- adversely affect ride comfort
- increase stopping distance



## Checking tire inflation pressure

### Safety notes

#### **WARNING**

Follow recommended tire inflation pressures.

Do not underinflate tires. Underinflated tires wear excessively and/or unevenly, adversely affect handling and fuel economy, and are more likely to fail from being overheated.

Do not overinflate tires. Overinflated tires can adversely affect handling and ride comfort, wear unevenly, increase stopping distance, and result in sudden deflation (blowout) because they are more likely to become punctured or damaged by road debris, potholes etc.

Do not overload the tires by exceeding the specified load limit as indicated on the Tire and Loading Information placard on the driver's door B-pillar. Overloading the tires can overheat them, possibly causing a blowout. Overloading the tires can also result in handling or steering problems, or brake failure.

Check the tire inflation pressure at least once a month.

Check and adjust the tire inflation pressure when the tires are cold (▷ page 125).

### Checking tire inflation pressure manually

Follow the steps below to achieve correct tire inflation pressure:

- ▶ Remove the cap from the valve on one tire.
- ▶ Firmly press a tire gauge onto the valve.
- ▶ Read the tire inflation pressure on tire gauge and check against the recommended tire inflation pressure on the Tire and Loading Information placard on the driver's door B-pillar (▷ page 130). If necessary, add air to achieve the recommended tire inflation pressure.

- ▶ If you have overfilled the tire, release tire inflation pressure by pushing the metal stem of the valve with e.g. a tip of a pen. Then recheck the tire inflation pressure with the tire gauge.
- ▶ Install the valve cap.
- ▶ Repeat this procedure for each tire.

### Tire Pressure Monitoring System (TPMS)\*

Your vehicle may be equipped with a **Tire Pressure Monitoring System (TPMS)**.

It monitors the tire inflation pressure in all four tires. A warning is issued to alert you to a decrease in pressure in one or more of the tires.

The Tire Pressure Monitoring System (TPMS) is equipped with a combination low tire pressure/TPMS malfunction telltale in the instrument cluster. Depending on how the telltale illuminates, it indicates a low tire pressure condition or a malfunction in the TPMS system itself:

- If the telltale illuminates continuously, one or more of your tires is significantly underinflated. There is no malfunction in the TPMS.
- If the telltale flashes for 60 seconds and then stays illuminated, the TPMS system itself is not operating properly.

The TPMS only functions on wheels that are equipped with the proper electronic sensors.

#### **WARNING**

The TPMS does not indicate a warning for wrongly selected inflation pressures. Always adjust tire inflation pressure according to the Tire and Loading Information placard on the driver's door B-pillar.

The TPMS is not able to issue a warning due to a sudden dramatic loss of pressure (e.g. tire blowout caused by a foreign object). In this case bring the vehicle to a halt by

\* optional

carefully applying the brakes and avoiding abrupt steering maneuvers.

 **WARNING**

Each tire should be checked monthly when cold and inflated to the inflation pressure recommended by the vehicle manufacturer on the Tire and Loading Information placard. If your vehicle has tires of a different size than the size indicated on the Tire and Loading Information placard, you should determine the proper tire inflation pressure for those tires.

As an added safety feature, your vehicle has been equipped with a tire pressure monitoring system (TPMS) that illuminates a low tire pressure telltale when one or more of your tires is significantly underinflated. Accordingly, when the low tire pressure telltale illuminates, you should stop and check your tires as soon as possible, and inflate them to the proper pressure. Driving on a significantly underinflated tire causes the tire to overheat and can lead to tire failure.

Underinflation also reduces fuel efficiency and tire tread life, and may affect the vehicle's handling and stopping ability. Please note that the TPMS is not a substitute for proper tire maintenance, and it is the driver's responsibility to maintain correct tire pressure, even if underinflation has not reached the level to trigger illumination of the TPMS low tire pressure telltale.

Your vehicle has also been equipped with a TPMS malfunction indicator to indicate when the system is not operating properly. The TPMS malfunction indicator is combined with the low tire pressure telltale. When the system detects a malfunction, the telltale will flash for approximately 1 minute and then remain continuously illuminated.

This sequence will continue upon subsequent vehicle start-ups as long as the mal-

function exists. When the malfunction indicator is illuminated, the system may not be able to detect or signal low tire pressure as intended.

TPMS malfunctions may occur for a variety of reasons, including the installation of incompatible replacement or alternate tires or wheels on the vehicle that prevent the TPMS from functioning properly. Always check the TPMS malfunction telltale after replacing one or more tires or wheels on your vehicle to ensure that the replacement or alternate tires and wheels allow the TPMS to continue to function properly.

**i** If a condition causing the TPMS to malfunction develops, it may take up to 10 minutes for the system to signal a malfunction using the TPMS telltale flashing and illumination sequence.

The telltale extinguishes after a few minutes driving if the malfunction has been corrected.

**i** Operating radio transmission equipment (e.g. wireless headsets, two-way radios) in or near the vehicle could cause the TPMS to malfunction.

**i** USA only:

This device complies with Part 15 of the FCC Rules. Operation is subject to the following two conditions:

- This device may not cause harmful interference, and
- this device must accept any interference received, including interference that may cause undesired operation.

Any unauthorized modification to this device could void the user's authority to operate the equipment.

**i** Canada only:

This device complies with RSS-210 of Industry Canada. Operation is subject to the following two conditions:

- This device may not cause interference, and
- this device must accept any interference received, including interference that may cause undesired operation of the device.

Any unauthorized modification to this device could void the user's authority to operate the equipment.

### Restarting the TPMS

**⚠ WARNING**

It is the driver's responsibility to calibrate the TPMS on the recommended cold inflation pressure. Underinflated tires affect the ability to steer or brake and might cause you to lose control of the vehicle.

When you restart the TPMS, the system sets new reference values for each tire.

The TPMS must be restarted when you have adjusted the tire inflation pressure to a new level (e.g. because of different load or driving conditions). The TPMS is then recalibrated to the current tire inflation pressures.

- ▶ Using the Tire and Loading Information placard on the driver's door B-pillar (▷ page 130), make sure the tire inflation pressure of all four tires is correct.

- i** Restart the TPMS after adjusting the tire inflation pressure to the inflation pressure recommended for the vehicle operating condition. Tire pressure should only be adjusted on cold tires. Observe the recommended tire inflation pressure on the Tire and Loading Information placard on the driver's door B-pillar (▷ page 130).

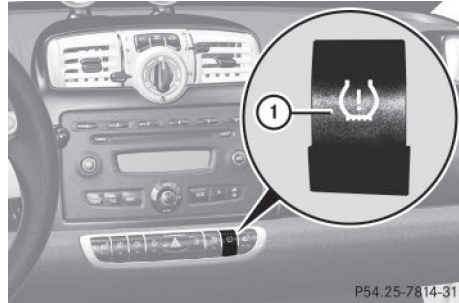

- ▶ Press Restarting TPMS button ①. The combination low tire pressure/TPMS malfunction telltale in the instrument cluster (▷ page 21) flashes for approximately 5 seconds and then goes out.

After driving a few minutes the system verifies that the current tire inflation pressures are within the system's specified range. Afterwards the current tire inflation pressures are accepted as reference pressures and then monitored.

### Maximum tire inflation pressure

**⚠ WARNING**

Never exceed the max. tire inflation pressure. Follow recommended tire inflation pressures.

Do not underinflate tires. Underinflated tires wear excessively and/or unevenly, adversely affect handling and fuel economy, and are more likely to fail from being overheated.

Do not overinflate tires. Overinflated tires can adversely affect handling and ride comfort, wear unevenly, increase stopping distance, and result in sudden deflation (blowout) because they are more likely to become punctured or damaged by road debris, potholes etc.



- i** For illustration purposes only. Actual data on tires are specific to each vehicle and may vary from data shown in above illustration.

This is the maximum permissible tire inflation pressure ① for the tire.

Always follow the recommended tire inflation pressure (> page 125) for proper tire inflation.

### Loading the vehicle

Two labels on your vehicle show how much weight it may properly carry.

- 1) The Tire and Loading Information placard can be found on the driver's door B-pillar. This placard tells you important information about the number of people that can be in the vehicle and the total weight that can be carried in the vehicle. It also contains information on the proper size and recommended tire inflation pressures for the original equipment tires on your vehicle.
- 2) The certification label, also found on the driver's door B-pillar, tells you about the gross weight capacity of your vehicle, called the Gross Vehicle Weight Rating (GVWR). The GVWR includes the weight of the vehicle, all occupants, fuel and cargo. The certification label also tells you about the front and rear axle weight capacity, called the Gross Axle Weight Rating

(GAWR). The GAWR is the total allowable weight that can be carried by a single axle (front or rear). Never exceed the GVWR or GAWR for either the front axle or rear axle.

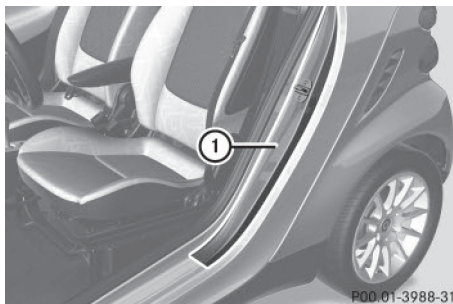

- ① Driver's door B-pillar

Following is a discussion on how to work with the information contained on the Tire and Loading Information placard with regards to loading your vehicle.

### Tire and Loading Information

#### **⚠ WARNING**

Do not overload the tires by exceeding the specified load limit as indicated on the Tire and Loading Information placard on the driver's door B-pillar. Overloading the tires can overheat them, possibly causing a blowout. Overloading the tires can also result in handling or steering problems, or brake failure.

#### Tire and Loading Information placard

- i** Data shown on Tire and Loading Information placard example are for illustration purposes only. Load limit data are specific to each vehicle and may vary from data shown in the following illustration. Refer to Tire and Loading Information placard on vehicle for actual data specific to your vehicle.

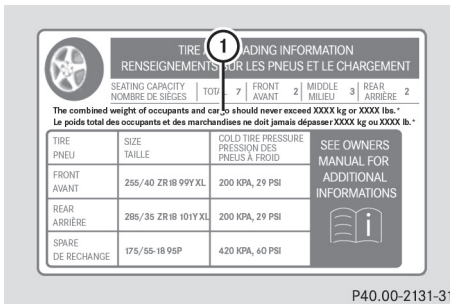

The Tire and Loading Information placard showing load limit information ① is located on the driver's door B-pillar (▷ page 130).

- ▶ Locate the statement "The combined weight of occupants and cargo should never exceed XXXX kg or XXXX lbs." on the Tire and Loading Information placard. The combined weight of all occupants and cargo/luggage should never exceed the weight referenced in that statement.

### Seating capacity

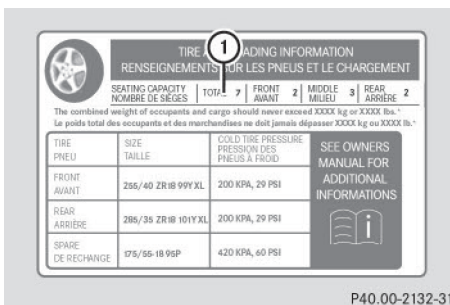

The seating capacity gives you important information on the number of occupants that can be in the vehicle. The Tire and Loading Information placard showing seating capacity ① is located on the driver's door B-pillar (▷ page 130).

- ① Data shown on Tire and Loading Information placard example are for illustration purposes only. Seating capacity data are specific to each vehicle and may vary from data shown in the following illustration. Refer to Tire and Loading

Information placard on vehicle for actual data specific to your vehicle.

### Steps for determining correct load limit

The following steps have been developed as required of all manufacturers under Title 49, Code of U.S. Federal Regulations, Part 575 pursuant to the "National Traffic and Motor Vehicle Safety Act of 1966".

- ▶ **Step 1:** Locate the statement "The combined weight of occupants and cargo should never exceed XXXX kg or XXXX lbs." on your vehicle's Tire and Loading Information placard.
- ▶ **Step 2:** Determine the combined weight of the driver and passenger that will be riding in your vehicle.
- ▶ **Step 3:** Subtract the combined weight of the driver and passenger from XXXX kilograms or XXXX lbs.
- ▶ **Step 4:** The resulting figure equals the available amount of cargo and luggage load capacity. For example, if the "XXXX" amount equals 540 lbs and there will be one 150 lbs passenger in your vehicle, the amount of available cargo and luggage load capacity is 390 lbs (540 lbs - 150 lbs = 390 lbs).
- ▶ **Step 5:** Determine the combined weight of luggage and cargo being loaded on the vehicle. That weight may not safely exceed the available cargo and luggage load capacity calculated in step 4.

- ① The maximum cargo compartment load is 110 lbs (50 kg).

The following table shows examples on how to calculate total and cargo load capacities with varying seating configurations and number and size of occupants. The following examples use a load limit of 540 lbs.

### This is for illustration purposes only.

Make sure you are using the actual load limit for your vehicle stated on the vehicle's Tire and Loading Information placard (▷ page 130).

The higher the weight of all occupants, the less cargo and luggage load capacity is available.



**>> Operation.**

Examples for steps 1 to 3

		Example 1	Example 2
Step 1	Combined weight limit of occupants and cargo from Tire and Loading Information placard	540 lbs	540 lbs
Step 2	Number of occupants (driver and passenger)	2	1
	Occupants weight	Occupant 1: 150 lbs Occupant 2: 180 lbs	Occupant 1: 150 lbs
	Combined weight of all occupants	330 lbs	150 lbs
Step 3	Available cargo weight (total load limit from Tire and Loading Information placard minus combined weight of all occupants)	540 lbs - 330 lbs = 210 lbs	540 lbs - 150 lbs = 390 lbs

>> Operation.

Certification label

Even after careful determination of the combined weight of all occupants and cargo as to not exceed the permissible load limit, you must make sure your vehicle never exceeds the Gross Vehicle Weight Rating (GVWR) and the Gross Axle Weight Rating (GAWR) for either the front or rear axle. You can obtain the GVWR and GAWR from the certification label. The certification label can be found on the driver's door B-pillar, see "Technical data" (▷ page 214).

Gross Vehicle Weight Rating (GVWR) means: The total weight of the vehicle, all occupants, and all cargo must never exceed the GVWR.

Gross Axle Weight Rating (GAWR) means: The total allowable weight that can be carried by a single axle (front or rear).

To assure that your vehicle does not exceed the maximum permissible weight limits (GVWR and GAWR for front and rear axle), have the loaded vehicle (including driver, passenger, and all cargo) weighed on a suitable commercial scale.

Maximum tire load

**⚠ WARNING**

Do not overload the tires by exceeding the specified load limit as indicated on the Tire and Loading Information placard on the driver's door B-pillar. Overloading the tires can overheat them, possibly causing a blowout. Overloading the tires can also result in handling or steering problems, or brake failure.

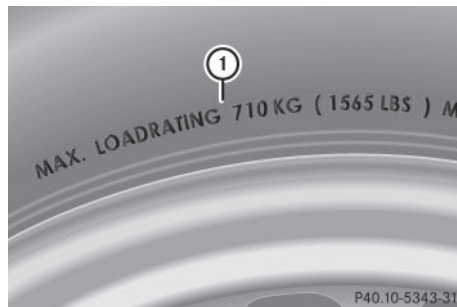

**i** For illustration purposes only. Actual data on tires are specific to each vehicle and may vary from data shown in above illustration.

The maximum tire load ① is the maximum weight the tires are designed to support.

For more information on tire load rating (▷ page 137).

For information on calculating total and cargo load capacities (▷ page 131).

### Direction of rotation

Unidirectional tires offer added advantages, such as better hydroplaning performance. To benefit, however, you must make sure the tires rotate in the direction specified.

An arrow on the sidewall indicates the intended direction of rotation (spinning) of the tire.

### Tire care and maintenance

#### WARNING

Regularly check the tires for damage. Damaged tires can cause tire inflation pressure loss. As a result, you could lose control of your vehicle.

Worn, old tires can cause accidents. If the tire tread is badly worn, or if the tires have sustained damage, replace them.

Check the tire inflation pressure at least once a month. For more information on checking tire inflation pressure, see “Recommended tire inflation pressure” (▷ page 125).

### Tire inspection

Every time you check the tire inflation pressure, you should also inspect your tires for the following

- excessive treadwear (▷ page 134)
- cord or fabric showing through the tire’s rubber
- bumps, bulges, cuts, cracks or splits in the tread or side of the tire

Replace the tire if you find any of the above conditions.

### Life of tire

#### WARNING

Tires should be replaced after 6 years, regardless of the remaining tread.

The service life of a tire is dependent upon varying factors including but not limited to

- driving style
- tire inflation pressure
- distance driven

### Tread depth

#### WARNING

Although the applicable federal motor vehicle safety laws consider a tire to be worn when the treadwear indicators (TWI) become visible at approximately  $\frac{1}{16}$  in (1.6 mm), we recommend that you do not allow your tires to wear down to that level. As tread depth approaches  $\frac{1}{8}$  in (3 mm), the adhesion properties on a wet road are sharply reduced.

Depending upon the weather and/or road surface (conditions), the tire traction varies widely.

Do not allow your tires to wear down too far. Adhesion properties on wet roads are sharply reduced at tread depths of less than  $\frac{1}{8}$  in (3 mm).

Treadwear indicators (TWI) are required by law. These indicators are located in six places on the tread circumference and become visible at a tread depth of approximately  $\frac{1}{16}$  in (1.6 mm), at which point the tire is considered worn and should be replaced.

Recommended minimum tire tread depth:

Summer tires  $\frac{1}{8}$  in (3 mm)

Winter tires  $\frac{1}{6}$  in (4 mm)



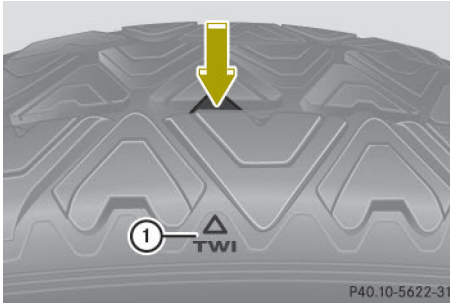

Treadwear indicator ① appears as a solid band across the tread.

### Storing tires

**!** Keep unmounted tires in a cool, dry place with as little exposure to light as possible. Protect tires from contact with oil, grease and fuels.

### Cleaning tires

**!** Never use a round nozzle to power wash tires. The intense jet of water can result in damage to the tire.

Always replace a damaged tire.

### Uniform Tire Quality Grading Standards

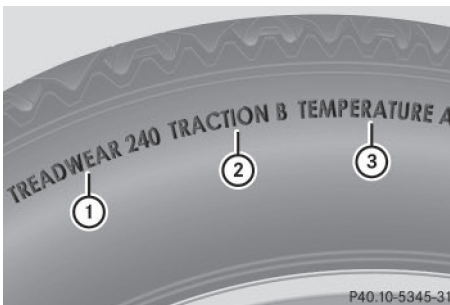

The Uniform Tire Quality Grading is a U.S. Government requirement designed to give drivers consistent and reliable information regarding tire performance. Tire manufacturers are required to grade tires based on three performance factors: tread-

wear ①, traction ②, and temperature resistance ③. Although not a Government of Canada requirement, all tires made for sale in North America have these grades branded on the sidewall.

**i** For illustration purposes only. Actual data on tires are specific to each vehicle and may vary from data shown in above illustration.

Quality grades can be found, where applicable, on the tire sidewall between tread shoulder and maximum section width. For example:

Treadwear	Traction	Temperature
200	AA	A

All passenger car tires must conform to federal safety requirements in addition to these grades.

### Treadwear

The treadwear grade is a comparative rating based on the wear rate of the tire when tested under controlled conditions on a specified U.S. government test course. For example, a tire graded 150 would wear one and one-half ( $1\frac{1}{2}$ ) times as well on the government course as a tire graded 100.

The relative performance of tires depends upon the actual conditions of their use, however, and may depart significantly from the norm due to variations in driving habits, service practices and differences in road characteristics and climate.

### Traction

#### **⚠ WARNING**

The traction grade assigned to this tire is based on straight-ahead braking traction tests, and does not include acceleration, cornering, hydroplaning, or peak traction characteristics.

The traction grades, from highest to lowest, are AA, A, B, and C. Those grades represent the tire's ability to stop on wet pavement as measured under controlled conditions on specified government test surfaces of asphalt and concrete. A tire marked C may have poor traction performance.

### Temperature

#### ⚠ WARNING

The temperature grade for this tire is established for a tire that is properly inflated and not overloaded. Excessive speed, underinflation, or excessive loading, either separately or in combination, can cause excessive heat build-up and possible tire failure.

The temperature grades are A (the highest), B, and C, representing the tire's resistance to the generation of heat and its ability to dissipate heat when tested under controlled conditions on a specified indoor laboratory test wheel. Sustained high temperature can cause the material of the tire to degenerate and reduce tire life, and excessive temperature can lead to sudden tire failure. The grade C corresponds to a level of performance which all passenger car tires must meet under the Federal Motor Vehicle Safety Standard No. 109. Grades B and A represent higher levels of performance on the laboratory test wheel than the minimum required by law.

### Rotating tires

#### ⚠ WARNING

Do not rotate front and rear wheels as they have different dimensions, e.g. rim size, wheel offset etc. Otherwise, the handling can be affected and you could endanger yourself and others.

Thoroughly clean the mounting face of the wheels and brake discs, i.e. the inner side of the wheels/tires each time the wheels/tires are changed. Check for and ensure proper tire inflation pressure.

#### ⚠ WARNING

Have the tightening torque checked after changing a wheel. Wheels could become loose if not tightened with a torque of 81 lb-ft (110 Nm).

Only use genuine smart wheel bolts specified for your vehicle's rims.

For information on wheel change, see "Flat tire" (> page 186).

### Tire labeling

Besides tire name (sales designation) and manufacturer name, a number of markings can be found on a tire.

Following are some explanations for the markings on your vehicle's tires:

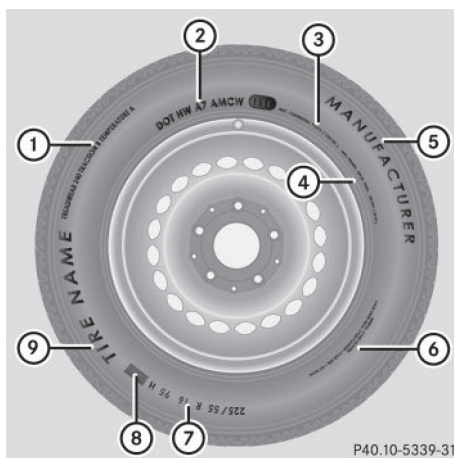

- ① Uniform Quality Grading Standards (> page 135)
- ② DOT, Tire Identification Number (TIN) (> page 139)
- ③ Maximum tire load (> page 133)
- ④ Maximum tire inflation pressure (> page 129)

- ⑤ Manufacturer
- ⑥ Tire ply material (▷ page 140)
- ⑦ Tire size designation, load and speed rating (▷ page 137)
- ⑧ Load identification (▷ page 139)
- ⑨ Tire name
- ❗ For illustration purposes only. Actual data on tires are specific to each vehicle and may vary from data shown in above illustration.  
For more information, see "Rims and tires" (▷ page 216).

### Tire size designation, load and speed rating

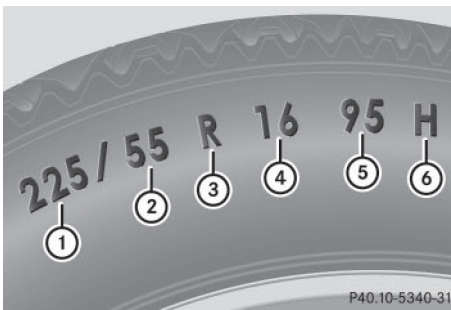

- ① Tire width
- ② Aspect ratio in %
- ③ Radial tire code
- ④ Rim diameter
- ⑤ Tire load rating
- ⑥ Tire speed rating
- ❗ For information purposes only. Actual data on tires are specific to each vehicle and may vary from data shown in above illustration.

#### General:

Depending on the design standards used, the tire size molded into the sidewall may have no letter or a letter preceding the tire size designation.

No letter preceding the size designation (as illustrated above): Passenger car tire based on European design standards.

Letter "P" preceding the size designation: Passenger car tire based on U.S. design standards.

Letter "LT" preceding the size designation: Light Truck tire based on U.S. design standards.

Letter "T" preceding the size designation: Temporary spare tires which are high pressure compact spares designed for temporary emergency use only.

#### Tire width

Tire width ① indicates the nominal tire width in mm.

#### Aspect ratio

Aspect ratio ② is the dimensional relationship between tire section height and section width and is expressed as a percentage. The aspect ratio is arrived at by dividing section height by section width.

#### Tire code

Tire code ③ indicates the tire construction type. The "R" stands for radial tire type. Letter "D" means diagonal or bias ply construction; letter "B" means belted-bias ply construction.

At the tire manufacturer's option, any tire with a speed capability above 149 mph (240 km/h) can include a "ZR" in the size designation (for example: 245/40 ZR 18). For additional information, see "Tire speed rating" (▷ page 138).

#### Rim diameter

Rim diameter ④ is the diameter of the bead seat, not the diameter of the rim edge. Rim diameter is indicated in inches (in).

#### Tire load rating

##### ⚠ WARNING

The tire load rating must always be at least half of the GAWR of your vehicle. Otherwise, tire failure may result and cause an accident and/or serious personal injury to you or others.

Always replace rims and tires with the same designation, manufacturer and type as shown on the original part.

 **WARNING**

Do not overload the tires by exceeding the specified load limit as indicated on the Tire and Loading Information placard on the driver's door B-pillar. Overloading the tires can overheat them, possibly causing a blowout. Overloading the tires can also result in handling or steering problems, or brake failure.

Tire load rating  is a numerical code associated with the maximum load a tire can support.

For example, a load rating of 91 corresponds to a maximum load of 1356 lbs (615 kg) the tire is designed to support. See also "Maximum tire load" (> page 133) where the maximum load associated with the load index is indicated in kilograms and lbs.

For additional information on tire load rating, see "Load identification" (> page 139).

### Tire speed rating

 **WARNING**

Even when permitted by law, never operate a vehicle at speeds greater than the maximum speed rating of the tires.

Exceeding the maximum speed for which tires are rated can lead to sudden tire failure, causing loss of vehicle control and possibly resulting in an accident and/or personal injury and possible death, for you and for others.



Regardless of the tire speed rating, local speed limits should be obeyed. Use prudent driving speeds appropriate to prevailing conditions.

Tire speed rating  indicates the approved maximum speed for the tire.

### Summer tires

Index	Speed rating
Q	up to 100 mph (160 km/h)
R	up to 106 mph (170 km/h)
S	up to 112 mph (180 km/h)
T	up to 118 mph (190 km/h)
H	up to 130 mph (210 km/h)
V	up to 149 mph (240 km/h)
W	up to 168 mph (270 km/h)
Y	up to 186 mph (300 km/h)
ZR...Y	above 186 mph (300 km/h)
ZR...(Y)	above 186 mph (300 km/h)
ZR	above 149 mph (240 km/h)

- At the tire manufacturer's option, any tire with a speed capability above 149 mph (240 km/h) can include a "ZR" in the size designation (for example: 245/40 ZR18). To determine the maximum speed capability of the tire, the service description for the tire must be referred to.

The service description is comprised of tire load rating  and tire speed rating .

If your tire includes "ZR" in the size designation and no service description is given, the tire manufacturer must be consulted for the maximum speed capability.

If a service description is given, the speed capability is limited by the speed symbol in the service description.

Example: 245/40 ZR18 97Y.

In this example, "97Y" is the service description. The letter "Y" designates the speed rating and the speed capabil-

ity of the tire is limited to 186 mph (300 km/h).

- Any tire with a speed capability above 186 mph (300 km/h) must include a “ZR” in the size designation AND the service description must be placed in parenthesis. Example: 275/40 ZR 18 (99Y). The “(Y)” speed rating in parenthesis designates the maximum speed capability of the tire as being above 186 mph (300 km/h). Consult the tire manufacturer for the actual maximum permissible speed of the tire.

All-season and winter tires

Index	Speed rating
Q M+S <sup>15</sup>	up to 100 mph (160 km/h)
T M+S <sup>15</sup>	up to 118 mph (190 km/h)
H M+S <sup>15</sup>	up to 130 mph (210 km/h)
V M+S <sup>15</sup>	up to 149 mph (240 km/h)

- i** Not all M+S rated tires provide special winter performance. Make sure the tires you use show M+S and the mountain/snowflake marking  on the tire sidewall. These tires meet specific snow traction performance requirements of the Rubber Manufacturers Association (RMA) and the Rubber Association of Canada (RAC) and have been designed specifically for use in snow conditions.

### Load identification



- i** For illustration purposes only. Actual data on tires are specific to each vehicle and may vary from data shown in above illustration.

In addition to the tire load rating, special load identification ① may be molded into the tire sidewall following the letter designating the tire speed rating ⑥ (> page 138).

No specification given: absence of any text (like in above example) indicates a standard load (SL) tire.

XL or Extra Load: designates an extra load (or reinforced) tire.

Light Load: designates a light load tire.

C, D, E: designates load range associated with the maximum load a tire can carry at a specified pressure.

### DOT, Tire Identification Number (TIN)

U.S. tire regulations require each new tire manufacturer or tire retreader to mold a TIN into or onto a sidewall of each tire produced.

>> Operation.

<sup>15</sup> or M+S  for winter tires.

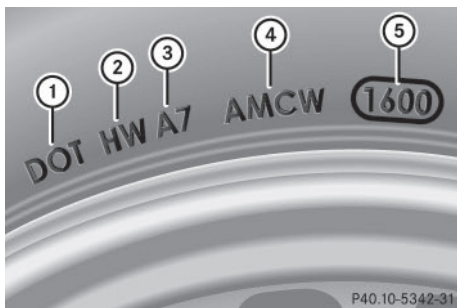

## >> Operation.

The TIN is a unique identifier which facilitates efforts by tire manufacturers to notify purchasers in recall situations or other safety matters concerning tires and gives purchasers the means to easily identify such tires.

The TIN is comprised of "Manufacturer's identification mark" ②, "Tire size" ③, "Tire type code" ④, and "Date of manufacture" ⑤.

**i** For illustration purposes only. Actual data on tires are specific to each vehicle and may vary from data shown in above illustration.

### DOT (Department of Transportation)

Tire branding symbol ① which denotes the tire meets requirements of the U.S. Department of Transportation.

### Manufacturer's identification mark

Manufacturer's identification mark ② denotes the tire manufacturer.

New tires have a mark with two symbols. Retreaded tires have a mark with four symbols. For more information on retreaded tires (▷ page 124).

### Tire size

Code ③ indicates the tire size.

### Tire type code

Tire type code ④ may, at the option of the manufacturer, be used as a descriptive code for identifying significant characteristics of the tire.

### Date of manufacture

Date of manufacture ⑤ identifies the week and year of manufacture.

The first two figures identify the week, starting with "01" to represent the first full week of the calendar year. The second two figures represent the year.

For example, "3202" represents the 32nd week of 2002.

### Tire ply material

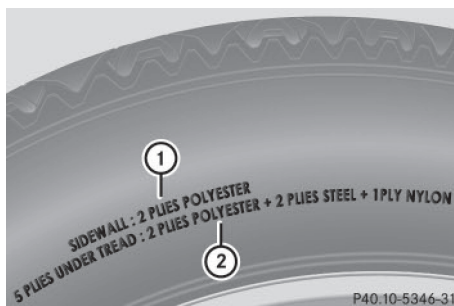

**i** For illustration purposes only. Actual data on tires are specific to each vehicle and may vary from data shown in above illustration.

This marking tells you about the type of cord and number of plies in the sidewall ① and under the tread ②.

### Tire and loading terminology

#### Accessory weight

The combined weight (in excess of those standard items which may be replaced) of automatic transmission, power steering, power brakes, power windows, power seats,

radio, and heater, to the extent that these items are available as factory-installed equipment (whether installed or not).

### **Air pressure**

---

The amount of air inside the tire pressing outward on each square inch of the tire. Air pressure is expressed in pounds per square inch (psi), or kilopascal (kPa) or bars.

### **Aspect ratio**

---

Dimensional relationship between tire section height and section width expressed in percentage.

### **Bar**

---

Another metric unit for air pressure. There are 14.5038 pounds per square inch (psi) to 1 bar; there are 100 kilopascals (kPa) to 1 bar.

### **Bead**

---

The tire bead contains steel wires wrapped by steel cords that hold the tire onto the rim.

### **Cold tire inflation pressure**

---

Tire inflation pressure when your vehicle has been sitting for at least 3 hours or driven no more than 1 mile (1.6 km).

### **Curb weight**

---

The weight of a motor vehicle with standard equipment including the maximum capacity of fuel, oil, and coolant, and, if so equipped, air conditioning and additional optional equipment, but without passengers and cargo.

### **DOT (Department of Transportation)**

---

A tire branding symbol which denotes the tire meets requirements of the U.S. Department of Transportation.

### **GAWR (Gross Axle Weight Rating)**

---

The GAWR is the maximum permissible axle weight. The gross vehicle weight on each axle must never exceed the GAWR for the front and rear axle indicated on the certification label located on the driver's door B-pillar.

### **GVW (Gross Vehicle Weight)**

---

The GVW comprises the weight of the vehicle including fuel, tools, installed accessories, passengers and cargo. The GVW must never exceed the GVWR indicated on the certification label located on the driver's door B-pillar.

### **GVWR (Gross Vehicle Weight Rating)**

---

This is the maximum permissible vehicle weight of the fully loaded vehicle (weight of the vehicle including all options, passengers, fuel, and cargo. It is indicated on certification label located on the driver's door B-pillar.

### **Kilopascal (kPa)**

---

The metric unit for air pressure. There are 6.9 kPa to 1 psi; another metric unit for air pressure is bars. There are 100 kilopascals (kPa) to 1 bar.

### **Maximum load rating**

---

The maximum load in kilograms and pounds that can be carried by the tire.

### **Maximum loaded vehicle weight**

---

The sum of curb weight, accessory weight, total load limit and production options weight.

### **Maximum permissible tire inflation pressure**

---

This number is the greatest amount of air pressure that should ever be put in the tire.

### **Normal occupant weight**

---

The number of occupants the vehicle is designed to seat, multiplied by 68 kilograms (150 lbs).

### **Occupant distribution**

---

The distribution of occupants in a vehicle at their designated seating positions.

### **Production options weight**

---

The combined weight of those installed regular production options weighing over 5 lbs (2.3 kilograms) in excess of those standard items which they replace, not previously considered in curb weight or accessory weight, including heavy duty brakes, ride levelers, roof rack, heavy duty battery, and special trim.

### **PSI (Pounds per square inch)**

---

A standard unit of measure for air pressure.

### **Recommended tire inflation pressure**

---

The recommended tire inflation pressure for normal driving conditions is listed on the Tire and Loading Information placard located on driver's door B-pillar and provides best handling, tread life and riding comfort.

### **Rim**

---

A metal support for a tire or a tire and tube assembly upon which the tire beads are seated.

### **Sidewall**

---

The portion of a tire between the tread and the bead.

### **TIN (Tire Identification Number)**

---

Unique identifier which facilitates efforts by tire manufacturers to notify purchasers in recall situations or other safety matters concerning tires and gives purchasers the means to easily identify such tires. The TIN is comprised of "Manufacturer's identification mark", "Tire size", "Tire type code" and "Date of manufacture".

### **Tire load rating**

---

Numerical code associated with the maximum load a tire can support.

### **Tire ply composition and material used**

---

This indicates the number of plies or the number of layers of rubber-coated fabric in the tire tread and sidewall. Tire manufacturers also must indicate the ply materials in the tire and sidewall, which include steel, nylon, polyester, and others.

### **Tire speed rating**

---

Part of tire designation; indicates the speed range for which a tire is approved.

### **Total load limit**

---

Rated cargo and luggage load plus 68 kilograms (150 lbs) times the vehicle's designated seating capacity.

### **Traction**

---

Force exerted by the vehicle on the road via the tires. The amount of grip provided.

### **Tread**

---

The portion of a tire that comes into contact with the road.



### Treadwear indicators

Narrow bands, sometimes called "wear bars" that show across the tread of a tire when only  $\frac{1}{16}$  in (1.6 mm) of tread remains.

### Uniform Tire Quality Grading Standards

A tire information system that provides consumers with ratings for a tire's traction, temperature and treadwear. Ratings are determined by tire manufacturers using U.S. government testing procedures. The ratings are molded into the sidewall of the tire.

### Vehicle maximum load on the tire

Load on an individual tire that is determined by distributing to each axle its share of the maximum loaded vehicle weight and dividing it by two.

## Winter driving

Before the onset of winter, have your vehicle winterized at an authorized smart center.

This service includes:

- Check of anticorrosion and antifreeze concentration.
- Addition of washer concentrate to the water of the windshield/rear window. Use a windshield washer concentrate labeled for winter which is formulated for temperatures below freezing point (▷ page 222).
- Battery test. Battery capacity drops with decreasing ambient temperature. A well charged battery helps to make sure the engine can be started, even at low ambient temperatures.
- Tire change.

\* optional

### Winter tires

#### WARNING

Winter tires with a tread depth of less than  $\frac{1}{6}$  in (4 mm) must be replaced. They are no longer suitable for winter operation.

Always use winter tires at temperatures below 45°F (7°C) and whenever wintry road conditions prevail. Not all M+S rated tires provide special winter performance. Make sure the tires you use show the mountain/snowflake marking  on the tire sidewall. These tires meet specific snow traction performance requirements of the Rubber Manufacturers Association (RMA) and the Rubber Association of Canada (RAC) and have been designed specifically for use in snow conditions. Use of winter tires is the only way to achieve the maximum effectiveness of the ABS and ESP® in winter operation.

For safe handling, make sure all mounted winter tires are of the same make and have the same tread design.

For information on winter tires for your vehicle model, see the "Technical data" section (▷ page 216).

Always observe the speed rating of the winter tires installed on your vehicle. If the maximum speed for which your tires are rated is below the speed rating of your vehicle, you must place a notice to this effect where it will be seen by the driver. Such notices are available at your tire dealer or any authorized smart center.

### Snow chains\*

- ! Remember that snow chains must always be compatible with the tire sizes of a vehicle. Snow chains that are approved by smart are only permitted for the following tire size:  
175/55 R15 on the rear axle.

For safety reasons, smart recommends that you only use snow chains that have been approved by smart.

Information on this is available from any smart center.

Please refer to the separate operating instructions for detailed information on mounting the snow chains.

Snow chains should only be driven on snow-covered roads at speeds not to exceed 30 mph (50 km/h). Remove chains as soon as possible when driving on roads without snow.

Please observe the following guidelines when using snow chains:

- Using snow chains is not permissible with all wheel/tire combinations (▷ page 216).
- Use snow chains in pairs and on rear wheels only. Follow the manufacturer's mounting instructions.
- Use of snow chains may be prohibited depending on location. Always check local and state laws before mounting snow chains.

#### WARNING

When mounting or removing snow chains, always park your vehicle on level ground, engage the parking brake, and turn off the engine. The vehicle could otherwise move and injure yourself or other road users.

#### WARNING

When mounting and removing snow chains, ensure that you and your vehicle are at a safe distance from moving traffic. Not doing so could endanger other road users or even lead to you being injured by the vehicles behind you.

#### WARNING

The vehicle's handling changes when driving with snow chains on any kind of road surface. This means that you should always

adapt your driving style to suit the current road and weather conditions.

- If snow chains that do not meet requirements are mounted, they may scrape against the body or axle components when the vehicle is in motion. This could result in damage to the rim/tire or vehicle.

## Driving instructions

### Drinking and driving

#### WARNING

Do not drink alcohol or take drugs and drive or allow anyone to drive who has been drinking alcohol or taking drugs. Even a small amount of alcohol or drugs can affect your reflexes, perceptions and judgment. The possibility of a serious or even fatal accident are greatly increased when you drink or take drugs and drive.

### Pedals

#### WARNING

Make sure absolutely no objects are obstructing the pedals' range of motion. Keep the driver's footwell clear of all obstacles. If there are any floor mats\* or carpets in the footwell, make sure the pedals still have sufficient clearance.

During sudden acceleration or braking maneuvers, the objects could get caught between or beneath the pedals and restrict your ability to brake or accelerate. This could lead to accidents and/or injury.

### Power assistance

#### WARNING

With the engine not running, there is no power assistance for the brake and steering\* systems. In this case, it is important

\* optional

to keep in mind that a considerably higher degree of effort is necessary to brake and steer the vehicle. Adapt your driving accordingly.

## Brakes

### WARNING

Make sure not to endanger any other road users when carrying out braking maneuvers.

Refer to the description of the hydraulic brake assistant (▷ page 47).

**!** Because the ESP® operates automatically, the engine must be turned off (ignition switched off) when the parking brake is being tested on a brake test dynamometer. Active braking action through the ESP® may otherwise seriously damage the brake system which is not covered by the smart Limited Warranty.

Brake pad wear or a leak in the brake system may be the reason for low brake fluid level in the brake fluid reservoir.

The brake fluid level in the brake fluid reservoir may be too low if the brake warning lamp in the instrument cluster comes on (▷ page 21) although the parking brake is released.

Have the brake system inspected immediately. Contact an authorized smart center. All checks and service work on the brake system should be carried out by qualified technicians only. Contact an authorized smart center.

Only install brake pads and use brake fluid recommended by smart.

## Inclines

**!** When driving down long and steep grades, relieve the load on the brakes by shifting into a lower gear to use the engine's braking power. This helps pre-

vent overheating of the brakes and reduces brake pad wear.

When using the engine's braking power, a drive wheel may not spin for an extended period of time, e.g. on slippery road surfaces. This may cause serious damage to the drive- train which is not covered by the smart Limited Warranty.

## High and low stresses

### WARNING

Resting your foot on the brake pedal will cause excessive and premature wear of the brake pads.

It can also result in the brakes overheating, thereby significantly reducing their effectiveness and your ability to stop the vehicle in sufficient time to avoid an accident.

After hard braking, it is advisable to drive on for some time, rather than immediately park, so that the air stream will cool down the brakes faster.

If your brake system is normally only subjected to moderate loads, you should occasionally test the effectiveness of the brakes by applying above-normal braking pressure at higher speeds. This will also enhance the grip of the brake pads.

### WARNING

Make sure not to endanger any other road users when carrying out these braking maneuvers.

## Wet road surface

### WARNING

After driving in heavy rain for some time without applying the brakes or through water deep enough to wet brake components, the first braking action may be somewhat reduced and increased pedal pressure may be necessary to obtain expected braking

effect. Maintain a safe distance from vehicles in front.

To help prevent brake disc corrosion after driving on wet road surfaces (particularly salted roads), it is advisable to brake the vehicle with considerable force prior to parking. The heat generated serves to dry the brakes.

 **WARNING**

Make sure not to endanger any other road users when carrying out these braking maneuvers.

### Limited braking effect on salted roads

Remember that the effect of the brakes can be limited on salted road surfaces. A layer of salt can form on brake discs and brake pads, considerably reducing the friction between the brake disc and the brake pad. The effect is most noticeable after long trips without braking, e.g. on the highway, and after the vehicle has been parked for several hours.

 **WARNING**

The accumulation of salt on brake discs and brake pads reduces braking effectiveness and increases the distance necessary to come to a complete standstill. This could potentially cause an accident and/or personal injury.

To avoid this risk, you should

- brake carefully every now and then on salted roads in order to remove any layer of salt on the brake disc and brake pad, but do so without endangering any other road users
- keep a good safe distance from the vehicle in front and drive carefully
- press the brake carefully at the end of the trip and again when beginning the next trip in order to remove any salt residues from the brake disc

### New brake pads

Only install brake pads recommended by smart.

 **WARNING**

If other than recommended brake pads are installed, or other than recommended brake fluid is used, the braking properties of the vehicle can be degraded to an extent that safe braking is substantially impaired. This could result in an accident.

 **WARNING**

New brake pads will not achieve their optimal braking effect until after several hundred miles (kilometers). This means that you must compensate for the reduced braking effect by pressing harder on the brake pedal and adapt your driving style accordingly. The same applies after brake pads or brake discs have been changed.

### Drive sensibly - save fuel

Fuel consumption, to a great extent, depends on driving habits and operating conditions.

To save fuel you should:

- Shift gears in a timely manner.
- Avoid frequent acceleration and deceleration.
- Keep tires at the recommended inflation pressures.
- Remove carriers\* when not in use.
- Remove unnecessary loads.
- Allow engine to warm up under low load use.
- Have all maintenance work performed at the intervals specified in the Maintenance Booklet and as required by the Maintenance System. Contact an authorized smart center.

Fuel consumption is also increased by driving in cold weather, in stop-and-go traffic, on short trips, and in hilly areas.

\* optional

### Catalytic converter

Your smart is equipped with monolithic-type catalytic converter, an important element in conjunction with the oxygen sensors to achieve substantial control of the pollutants in the exhaust emissions. Keep your vehicle in proper operating condition by following our recommended maintenance instructions as outlined in your Maintenance Booklet.

#### WARNING

The catalytic converter can become very hot. Coming into contact with the catalytic converter could result in burns.

Note the following:

- Do not remove the protective heat guards.
- Do not apply any underseal.
- As with any vehicle, do not idle, park, or operate this vehicle in areas where combustible materials such as grass, hay, or leaves can come into contact with the hot exhaust system, as these materials could be ignited and cause a vehicle fire.

**!** To prevent damage to the catalytic converter, only use premium unleaded gasoline in this vehicle.

Any noticeable irregularities in engine operation should be repaired promptly. Otherwise, excessive unburned fuel may reach the catalytic converter, causing it to overheat and potentially start a fire.

It is essential to observe the following points, as there is otherwise a danger of overheating and the catalytic converter may be damaged.

- Fill up only with premium unleaded gasoline. Even small quantities of leaded gasoline can damage the catalytic converter.
- Make sure you adhere to the prescribed service intervals.
- Never run the fuel tank empty.

- If the engine starts to misfire, bring the vehicle to an immediate standstill without endangering traffic.
- If the engine fails to start the first time, you should not try to start it any more than three times in succession.
- Do not try to start for more than four seconds at a time.

### Tires

#### WARNING

If you feel a sudden significant vibration or ride disturbance, or you suspect that possible damage to your vehicle has occurred, you should turn on the hazard warning flashers, carefully slow down, and drive with caution to an area which is a safe distance from the road.

Inspect the tires and the vehicle underbody for possible damage. If the vehicle or tires appear unsafe, have the vehicle towed to the nearest smart center or tire dealer for repairs.

Treadwear indicators (TWI) are required by law. These indicators are located in six places on the tread circumference and become visible at a tread depth of approximately  $\frac{1}{16}$  in (1.6 mm), at which point the tire is considered worn and should be replaced.

The treadwear indicator appears as a solid band across the tread.

#### WARNING

Although the applicable federal motor vehicle safety laws consider a tire to be worn when the treadwear indicators (TWI) become visible at approximately  $\frac{1}{16}$  in (1.6 mm), we recommend that you do not allow your tires to wear down to that level. As tread depth approaches  $\frac{1}{8}$  in (3 mm), the adhesion properties on a wet road are sharply reduced.

Depending upon the weather and/or road surface (conditions), the tire traction varies widely.

Specified tire inflation pressures must be maintained. This applies particularly if the tires are subject to high loads (e.g. high speeds, heavy loads, high ambient temperatures).

 **WARNING**

Do not drive with a flat tire. A flat tire will affect your ability to steer or brake and may cause you to lose control of the vehicle. Continued driving with a flat tire or driving at high speed with a flat tire will cause excessive heat build-up and possibly a fire.

For more information, see "Tires and wheels" (> page 124).

### Hydroplaning

Depending on the depth of the water layer on the road, hydroplaning may occur resulting in a loss of control, even at low speeds and with new tires. Reduce vehicle speed, avoid track grooves in the road and apply brakes cautiously when it is raining.

### Tire traction

The safe speed on a wet, snow covered or icy road is always lower than on a dry road. You should pay particular attention to the condition of the road whenever the outside temperatures are close to the freezing point.

 **WARNING**

If ice has formed on the road, tire traction will be substantially reduced. Under such weather conditions, drive, steer and brake with extreme caution.

smart recommends winter tires (> page 143) with a minimum tread depth of approx-

imately  $\frac{1}{6}$  in (4 mm) on all four wheels for the winter season to ensure normal balanced handling characteristics. On packed snow, they can reduce your stopping distance compared to summer tires.

Stopping distance, however, is still considerably greater than when the road is not covered with snow or ice. Exercise appropriate caution.

 Avoid spinning of a drive wheel for an extended period when driving off on slippery road surfaces. Otherwise, the drivetrain could be damaged, which is not covered by the smart Limited Warranty.

### Tire speed rating

Regardless of the tire speed rating, local speed limits should be obeyed. Use prudent driving speeds appropriate to prevailing conditions.

 **WARNING**

Even when permitted by law, never operate a vehicle at speeds greater than the maximum speed rating of the tires.

Exceeding the maximum speed for which tires are rated can lead to sudden tire failure, causing loss of vehicle control and possibly resulting in an accident and/or personal injury and possible death, for you and for others.

An electronic speed limiter prevents your vehicle from exceeding a speed of 90 mph (145 km/h).

The factory equipped tires on your vehicle may have a tire speed rating above the maximum speed permitted by the electronic speed limiter.

Make sure your tires have the required tire speed rating as specified for your vehicle in the "Technical data section" (> page 216), for example when purchasing new tires.

For information on how to identify the tire speed rating on a tire's sidewall, see "Tire size designation, load and speed rating" (▷ page 137).

If you are uncertain about the correct reading of the information given on a tire's sidewall, any authorized smart center will be glad to assist you.

- ❗ For information on speed ratings for winter tires, see "All-season and winter tires" (▷ page 138).

### Winter driving instructions

The most important rule for slippery or icy roads is to drive sensibly and to avoid abrupt acceleration, braking and steering maneuvers.

When the vehicle is in danger of skidding, move gear selector lever to neutral position **N**. Try to keep the vehicle under control by corrective steering action.

For information on driving with snow chains\*, see "Snow chains\*" (▷ page 143).

#### ⚠ WARNING

On slippery road surfaces, never downshift in order to obtain braking action. This could result in drive wheel slip and reduced vehicle control. Your vehicle's ABS will not prevent this type of loss of control.

Road salts and chemicals can adversely affect braking efficiency. Increased pedal force may become necessary to produce the normal braking effect.

Depressing the brake pedal periodically when traveling at length on salt-strewn roads can bring road-salt-impaired braking efficiency back to normal.

If the vehicle is parked after being driven on salt-treated roads, the braking efficiency should be tested as soon as possible after driving is resumed.

\* optional

#### ⚠ WARNING

Make sure not to endanger any other road users when carrying out these braking maneuvers.

#### ⚠ WARNING

If the vehicle becomes stuck in snow, make sure snow is kept clear of the exhaust pipe and from around the vehicle with the engine running. Otherwise, deadly carbon monoxide (CO) gases may enter vehicle interior resulting in unconsciousness and death. To assure sufficient fresh air ventilation, open a window slightly on the side of the vehicle not facing the wind.

#### ⚠ WARNING

The outside temperature display is not designed to serve as an ice-warning device and is therefore unsuitable for that purpose. Indicated temperatures just above the freezing point do not guarantee that the road surface is free of ice.

For more information, see "Winter driving" (▷ page 143).

### Standing water

- ❗ Do not drive through flooded areas or water of unknown depth. Before driving through water, determine its depth. Never accelerate before driving into water. The bow wave could force water into the engine and auxiliary equipment, thus damaging them.

If you must drive through standing water, drive slowly to prevent water from entering

- the front compartment
- the engine compartment
- the passenger compartment

Water in these areas could cause damage to electrical components or wiring of the engine or transmission, or could result in water being ingested by the engine through

the air intake, causing severe internal engine damage.

Any such damage is not covered by the smart Limited Warranty.

#### Passenger compartment

##### **WARNING**

Always fasten items being carried as securely as possible.

In an accident, during hard braking or sudden maneuvers, loose items thrown around inside the vehicle may injure vehicle occupants.

The cargo compartment is the preferred place to carry objects.

#### Control and operation of radio transmitters

##### Radio and telephone

##### **WARNING**

Please do not forget that your primary responsibility is to drive the vehicle safely. Only operate the radio or telephone <sup>16</sup> if road, weather and traffic conditions permit.

Bear in mind that at a speed of just 30 mph (approximately 50 km/h), your vehicle is covering a distance of 44 feet (approximately 14 m) every second.

##### Telephones and two-way radios

##### **WARNING**

Never operate radio transmitters equipped with a built-in or attached antenna (i.e. without being connected to an external antenna) from inside the vehicle while the engine is running. Doing so could lead to a malfunction of the vehicle's electronic system, possibly resulting in an accident and/or serious personal injury.

Radio transmitters, such as a mobile phone or a citizens band unit should only be used inside the vehicle if they are connected to an antenna that is installed on the outside of the vehicle.

Refer to the radio transmitter operation instructions regarding use of an external antenna.

#### Emission control

Certain engine systems serve to keep the toxic components of the exhaust gases within permissible legal limits.

These systems, of course, will function properly only when maintained strictly according to factory specifications.

Any adjustments to the engine should therefore be carried out only by qualified smart center authorized technicians.

Engine adjustments should not be altered in anyway. Moreover, the specified service jobs must be carried out regularly according to smart servicing requirements. For details refer to the Maintenance Booklet.

##### **WARNING**

Inhalation of exhaust gas is hazardous to your health. All exhaust gas contains carbon monoxide (CO), and inhaling it can cause unconsciousness and lead to death.

Do not run the engine in confined areas (such as a garage) which are not properly ventilated. If you think that exhaust gas fumes are entering the vehicle while driving, have the cause determined and corrected immediately. If you must drive under these conditions, drive only with at least one window fully open at all times.

#### Coolant temperature

During severe operating conditions and stop-and-go city traffic, the coolant temperature may rise.

<sup>16</sup> Observe all legal requirements.



**!** Excessive coolant temperature causes the red coolant temperature warning lamp  in the instrument cluster to come on.

The engine should not be operated with the red coolant temperature warning lamp  illuminated. Doing so may cause serious engine damage which is not covered by the smart Limited Warranty.

For more information on coolant temperature warning lamp (> page 170).

#### **WARNING**

Driving when your engine is overheated can cause some fluids which may have leaked into the engine compartment to catch fire. You could be seriously burned.

Steam from an overheated engine can cause serious burns which can occur just by opening the engine hood. Stay away from the engine if you see or hear steam coming from it.

Stop the vehicle in a safe location away from other traffic. Turn off the engine, get out of the vehicle and do not stand near the vehicle until the engine has cooled down.

#### **Driving abroad**

Abroad, there is an extensive smart service network at your disposal. If you plan to drive into areas which are not listed in the index of your smart center directory, you should request pertinent information from an authorized smart center.

#### **Symmetrical low beams**

**i** If you drive in countries where vehicles drive on the other side of the road than the country in which the vehicle is registered, you must have the headlamps modified for symmetrical low beams.

Relevant information can be obtained at any authorized smart center.

#### **Vehicle care**

##### **Care tips**

Regular and proper care will help to maintain the value of your vehicle. The best way to protect your vehicle from harmful environmental influences is to wash it and use protective treatments regularly.

smart recommends that you care for the paintwork at least twice a year (e.g. in the spring and autumn).

#### **WARNING**

Many cleaning products can be hazardous. Some are poisonous, others are flammable. Always follow the instructions on the particular container. Always open your vehicle's doors or windows when cleaning the inside.

Never use fluids or solvents that are not designed for cleaning your vehicle.

Always lock away cleaning products and keep them out of reach of children.

**!** Follow the care tips. Wash your vehicle preferably by hand.

While in operation or even while parked, your vehicle is subjected to varying external influences, which left unchecked can attack the paint as well as the vehicle underbody and lead to permanent damage. Such damage is caused not only by extreme and varying climatic conditions, but also by:

- Air pollution
- Road salt
- Tar
- Gravel and stone chipping

To avoid paint damage, you should immediately remove:

- Insects
- Bird droppings
- Tree sap, etc.
- Grease and oil
- Brake fluid
- Coolant
- Fuel
- Tar spots

**!** Failure to remove such dirt immediately can cause damage to the paint or the soft top fabric\*. Environmental influences are not covered by the smart Limited Warranty.

Frequent washing reduces and/or eliminates the aggressiveness and potency of the above adverse influences.

More frequent washings are necessary to deal with unfavorable conditions:

- near the ocean
- in industrial areas (smoke, exhaust emissions)
- during winter operation

You should check your vehicle from time to time for stone chipping or other damage. Any damage should be repaired as soon as possible to prevent corrosion.

In doing so, do not neglect the underbody of the vehicle. A prerequisite for a thorough check is a washing of the underbody followed by a thorough inspection. Damaged areas need to be re-undercoated.

Your vehicle has been treated at the factory with a wax-base rustproofing in the body cavities which will last for the lifetime of the vehicle. Post-production treatment is neither necessary nor recommended by smart because of the possibility of incompatibility between materials used in the production process and others applied later.

We have selected vehicle-care products and compiled recommendations which are specially matched to our vehicles and which always reflect the latest technology. You can obtain smart approved vehicle-care products at an authorized smart center.

Scratches, corrosive deposits, corrosion or damage due to negligent or incorrect care cannot always be removed or repaired with the vehicle-care products recommended here. In such cases it is best to seek aid at an authorized smart center.

The following topics deal with the cleaning and care of your vehicle and give important "how-to" information as well as references to smart approved vehicle-care products.

### Vehicle care

Contact an authorized smart center for recommended and approved care products.

**i** Advice on caring for the soft top system, see (> page 155).

#### WARNING

After washing the vehicle, the brakes may still be wet and thus their functionality impaired. Therefore, when you start off, brake lightly several times without endangering traffic.

**Selecting the right cleaning agent**

**!** To avoid damage to interior equipment and materials: Never rub roughly or use cleaning spirits on the cloth upholstery, never use strong agents, stain remover etc. on the leather upholstery. Never scour or use solvent on plastic parts. Never use strong and aggressive agents on windows, do not touch the inside of the windows with hard objects such as an ice scraper or ring, doing so may damage the windows.

Interior	Special considerations	Light soiling	Heavy soiling
Cloth upholstery	Use a clean, lint-free cloth	Light soap suds	Stain remover (test on an inconspicuous place first)
Plastic parts	Use a color-fast cloth	Damp, clean cloth, cockpit spray	Damp, clean cloth, cockpit spray
Leather upholstery	Use a clean, color-fast cloth	Clean cloth with lukewarm water, leather care product	Leather care product
Windows		Damp, clean cloth, microfiber cloth, glass cleaner	Microfiber cloth, glass cleaner

>> Operation.

**!** To avoid damage to exterior surfaces never do the following: Use aggressive paint cleaner, machine polish, abrasive cleanser, acidic, highly alkaline agents, abrasive sponges, high-pressure or hot water cleaning equipment.

Exterior	Special considerations	Lightly soiled Hand-/Automatic car washes	Heavily soiled Hand-/Automatic car washes
tridion safety cell, black	Powder coated single-coat paint finish	Car shampoo concentrate, insect remover for insect remains, polish	Car shampoo concentrate, hard wax, insect remover for insect remains, polish
tridion safety cell, silver	Powder coated single-coat paint finish and clearcoat		
Highly polished plastic parts (body panels)	Body panels with base coat and clearcoat or clearcoat only		

Exterior	Special considerations	Lightly soiled Hand-/Automatic car washes	Heavily soiled Hand-/Automatic car washes
Wheels and wheel covers	Two-layer metallic paint (high-gloss)	Car shampoo concentrate, rim care	Car shampoo concentrate, rim care
Retractable soft top	PAC fabric	Car shampoo concentrate, soft top cleaner, impregnation spray	Car shampoo concentrate, soft top cleaner, impregnation spray

## >> Operation.

### Removing insects

Remove insect remains before you start to wash the vehicle.

- ▶ Spray insect remover on.
- ▶ Allow insect remover to work in briefly.
- ▶ Rub in gently with a soft cloth or sponge.
- ▶ Rinse with plenty of water.
- ▶ Treat the cleaned surface with hard wax.

### Removing tar

Remove any tar marks before washing the vehicle.

- ▶ Apply tar remover with a soft cloth.
- ▶ Allow tar remover to work in briefly.
- ▶ Rub in gently.
- ▶ Rinse with plenty of water.
- ▶ Treat the cleaned surface with hard wax.

### Vehicle washing

In the winter, thoroughly remove all traces of road salt as soon as possible.

When washing the vehicle underbody, do not forget to clean the inner sides of the wheels.

### Washing your vehicle by hand

- ▶ Wash the vehicle using car shampoo concentrate and a sponge.
- ▶ Rinse with clean water.
- ▶ Towel dry the vehicle.

**!** Do not wash the vehicle in direct sunlight. The body panel surfaces and paint finish may be damaged.

### Washing your vehicle in an automatic car wash

**i** When running your vehicle through an automatic car wash, water droplets can run down the inside of the side windows.

Unscrew your vehicle's antenna before driving into an automatic car wash.

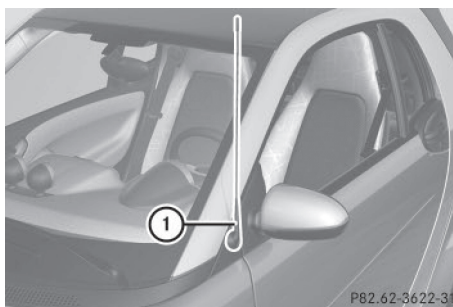

- ▶ **Removing:** Unscrew antenna ① counter-clockwise.
- ▶ **Fitting:** Screw antenna ① in clockwise.

### Power washer

#### **!** WARNING

Do not use a round nozzle (dirt grinders) to powerwash your vehicle, in particular the tires. You could otherwise damage the tires and cause an accident.

**!** Do not aim directly at

- electrical parts
- electrical connectors
- seals
- other rubber parts

The distance should be at least 3.9 in (10 cm) and the water temperature must not exceed 140°F (60°C). Follow the instructions provided by the power washer manufacturer on maintaining a distance between the vehicle and the nozzle of the power washer.

Always keep the jet of water moving across the surface.

### Wheel cover\*

- ▶ Wash the wheel cover with shampoo and a soft brush or in the car wash.

### Decorative foils

**!** Decorative foils are permanently adhered to the painted parts of the vehicle and cannot be removed.

**!** Do not expose the foils to solvents, gasoline or diesel.

**i** When cleaning with a power washer, note the following guideline values:

- Water temperature max. 176°F (80°C)
- Minimum distance 11.8 in (30 cm)
- Jet of water strike at a right angle

### Paintwork care

The frequency with which you care for your paintwork is dependent on

- how much the vehicle is used
- where you normally park the vehicle (e.g. in a garage or under a tree)
- the season
- weather and environmental influences

\* optional

### Rectifying paintwork damage

You can use a touch-up paint pen to repair minimal stone chip damage and scratches.

Recommended touch-up paint pens can be obtained in a smart center.

**i** For any major paintwork damage, please contact a smart center.

Exterior	Repair options
Plastic parts (body panels) with clearcoat	Clearcoat touch-up paint pen
Body panels with base coat and clearcoat	recommended touch-up paint pen set in the relevant color
tridion safety cell	recommended touch-up paint pen set in the relevant color

### Soft top system (cabriolet only)

Regular care will protect the retractable soft top and the rear soft top against external influences, helping to preserve its value. Use only an approved soft top cleaner when removing dirt from the soft top.

**!** Never clean the soft top using a power washer, as water could get into the inside of the vehicle.

### Cleaning the soft top fabric

**!** Only clean the retractable soft top and the rear soft top when they are closed.

### Dry cleaning

- ▶ Brush the soft top fabric with a soft brush, always working in the same direction, i.e. from front to back.

>> Operation.

**Wet cleaning**

smart recommends that you use an approved car shampoo concentrate and soft top cleaner.

- ▶ “Dry clean” the vehicle first.
- ▶ Wash the soft top off using a soft brush or sponge and plenty of lukewarm water.
- ▶ Then rinse thoroughly with clear water.

**i** If you have the vehicle cleaned in a car wash, you may find that some water gets into the interior.

>> Operation.



Where will I find ...	158
Display messages .....	158
What to do if ...	162
Unlocking/locking manually .....	176
Replacing transmitter battery .....	177
Replacing bulbs .....	178
Replacing wiper blades .....	184
Flat tire .....	186
Wheel change .....	194
Battery .....	196
Jump starting .....	199
Towing .....	202
Fuses .....	205

**>> Practical hints.**

### Where will I find ...

#### Tire repair kit

The tire repair kit is located in the passenger footwell under the carpet.

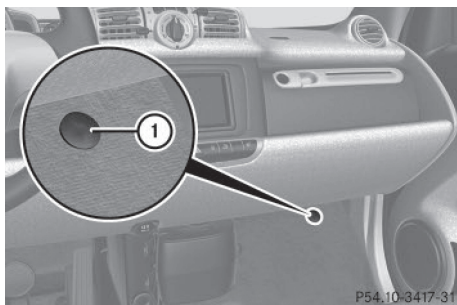

P54.10.3417-31

- ▶ Insert a suitable object such as a coin into the slot of carpet holder ①.
- ▶ Turn carpet holder ① counterclockwise.
- ▶ Lift the carpet.



P40.10.5917-31

#### ② Tire repair kit

The following is included:

- Tire sealant container
- Electric air pump with filler hose
- Sticker
- Operating instructions label (on the inside of the tire repair kit lid)

**i** The tire sealant container is located below the tire repair kit.

#### **⚠ WARNING**

The tire repair kit is a limited repair device. In case of a breakdown caused by a flat tire, read through the section flat tire

carefully. When using the tire repair kit follow the instructions in this section. Failure to follow these instructions can result in severe injury or death.

### Display messages



The following display messages appear in the multifunction display (▷ page 86).

You can confirm certain display messages on vehicles with control system\*.

- ▶ **Confirming messages:** Press the OK button on the control lever briefly (▷ page 93).

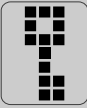

**Vehicles without control system**

Display messages	Possible causes/consequences and ► Solutions
	<p>The electronic immobilizer is not working.</p> <ul style="list-style-type: none"> <li>► Have the system checked at an authorized smart center.</li> </ul>
	<p>There is a malfunction in the shifting system.</p> <ul style="list-style-type: none"> <li>► Have the system checked at an authorized smart center.</li> </ul>
	<p>The transmission is taugt-in (▷ page 85).</p> <ul style="list-style-type: none"> <li>► Have the system checked at an authorized smart center.</li> </ul>

**Vehicles with control system\***

Display messages	Possible causes/consequences and ► Solutions
 <p>Switch Engine Off</p>	<p>The coolant is too hot.</p> <ul style="list-style-type: none"> <li>► Stop the vehicle immediately as soon as it is safe to do so.</li> <li>► Turn off the engine immediately.</li> <li>► Engage the parking brake.</li> <li>► Make sure the air supply for the radiator is uninterrupted.</li> <li>► Only start the engine again after the display message disappears. You could otherwise damage the engine.</li> </ul>

 **WARNING**

Driving when your engine is overheated can cause some fluids which may have leaked into the engine compartment to catch fire. You could be seriously burned.





Steam from an overheated engine can cause serious burns which can occur just by opening the engine hood. Stay away from the engine if you see or hear steam coming from it.

Stop the vehicle in a safe location away from other traffic. Turn off the engine, get out of the vehicle and do not stand near the vehicle until the engine has cooled down.

**!** Among other possible causes, the poly-V-belt could be broken. Do not continue to drive. Otherwise, the engine will overheat due to an inoperative water pump which may result in damage to the engine.





»» Practical hints.

\* optional

Display messages	Possible causes/consequences and ► Solutions
 Switch Engine Off	The engine oil level is too low. The engine could be damaged. <ul style="list-style-type: none"> <li>► Stop the vehicle as soon as it is safe to do so.</li> <li>► Turn off the engine.</li> <li>► Engage the parking brake.</li> <li>► Check the engine oil level (▷ page 118) and add engine oil as required (▷ page 119).</li> </ul>
 Release Parking Brake	You are driving with the parking brake engaged. <ul style="list-style-type: none"> <li>► Release the parking brake.</li> </ul>
 Shift to N or P to Start	You have attempted to start the engine while the automatic transmission was in reverse gear <b>R</b> or drive position <b>D</b> . Shift the automatic transmission into park position <b>P</b> or neutral position <b>N</b> .
 Apply Brakes to Start	You have attempted to start the engine without depressing the brake pedal. Depress the brake pedal to start the engine.

Display messages	Possible causes/consequences and ► Solutions
 Charge Battery	The battery is not being charged. Possible causes: <ul style="list-style-type: none"> <li>• alternator malfunctioning</li> <li>• broken poly-V-belt</li> </ul> <ul style="list-style-type: none"> <li>► Stop the vehicle immediately as soon as it is safe to do so.</li> <li>► Turn off the engine immediately.</li> <li>► Engage the parking brake.</li> <li>► Check the poly-V-belt.</li> <li>► <b>If poly-V-belt is broken:</b> Do not continue to drive. Contact an authorized smart center.</li> <li>► <b>If poly-V-belt is intact:</b> Have the vehicle checked at an authorized smart center immediately.</li> </ul>

**!** Among other possible causes, the poly-V-belt could be broken. Do not continue to drive. Otherwise, the engine will overheat due to an inoperative water pump which may result in damage to the engine.

Display messages	Possible causes/consequences and ► Solutions
 Reserve Fuel	The fuel level has dropped below the reserve mark. ► Refuel at the next gas station.
 Driver's Door Ajar	The driver's door is open. ► Close the driver's door.
 Door Ajar	The passenger door is open. ► Close the passenger door.
 Tailgate Open	A tailgate or the rear soft top <sup>17</sup> is open. ► Close the tailgates or the rear soft.

Display messages	Possible causes/consequences and ► Solutions
 Check Tire Pressure	The tire inflation pressure in at least one tire is significantly below the reference value. ► Carefully bring the vehicle to a halt, avoiding abrupt steering and braking maneuvers. ► Check and adjust tire inflation pressure as required (▷ page 127). ► If necessary, change the wheel (▷ page 194).

 **WARNING**

Each tire should be checked monthly when cold and inflated to the inflation pressure recommended by the vehicle manufacturer on the Tire and Loading Information placard. If your vehicle has tires of a different size than the size indicated on the Tire and Loading Information placard, you should determine the proper tire inflation pressure for those tires.

As an added safety feature, your vehicle has been equipped with a tire pressure monitoring system (TPMS) that illuminates a low tire pressure telltale when one or more of your tires is significantly underinflated.

Accordingly, when the low tire pressure telltale illuminates, you should stop and check your tires as soon as possible, and inflate them to the proper pressure. Driving on a significantly underinflated tire causes the tire to overheat and can lead to tire failure.

Underinflation also reduces fuel efficiency and tire tread life, and may affect the vehicle's handling and stopping ability. Please note that the TPMS is not a substitute for proper tire maintenance, and it is the driver's responsibility to maintain correct tire pressure, even if underinflation has not reached the level to trigger illumination of the TPMS low tire pressure telltale.

Your vehicle has also been equipped with a TPMS malfunction indicator to indicate when the system is not operating properly. The TPMS malfunction indicator is combined with the low

<sup>17</sup> cabriolet only.

>> Practical hints.

tire pressure telltale. When the system detects a malfunction, the telltale will flash for approximately 1 minute and then remain continuously illuminated.

This sequence will continue upon subsequent vehicle start-ups as long as the malfunction exists. When the malfunction indicator is illuminated, the system may not be able to detect or signal low tire pressure as intended.

TPMS malfunctions may occur for a variety of reasons, including the installation of incompatible replacement or alternate tires or wheels on the vehicle that prevent the TPMS from functioning properly. Always check the TPMS malfunction telltale after replacing one or more tires or wheels on your vehicle to ensure that the replacement or alternate tires and wheels allow the TPMS to continue to function properly.

>> Practical hints.

Display messages	Possible causes/consequences and ► Solutions
 <p><b>Danger: Ice</b> (Canada only)</p>	<p>The outside temperature is below 3°C. The road may be icy.</p> <ul style="list-style-type: none"> <li>► Adjust your driving style to the prevailing road and weather conditions.</li> <li>► <b>Confirming message:</b> Press the OK button on the control lever briefly (▷ page 93).</li> </ul>

 **WARNING**

The display message **Danger: Ice** is not designed as an ice-warning device and is therefore unsuitable for that purpose.

Indicated temperatures just above the freezing point do not guarantee that the road surface is free of ice. The road may still be icy, especially in wooded areas or on bridges. Your vehicle could start to skid if you do not adjust your driving style accordingly.

Therefore, always adjust your driving style to the prevailing road and weather conditions.





## What to do if ...

### Warning and indicator lamps in the instrument cluster

#### General information

If any of the following lamps in the instrument cluster fails to come on during the bulb self-check when switching on ignition (▷ page 57), have the respective bulb checked and replaced if necessary.

**Brake**

Problem	Possible causes/consequences and ► Solutions
<p> (USA only)   (Canada only)</p> <p>The ABS indicator lamp illuminates while the engine is running.</p>	<p>There is a malfunction in the ABS system.</p> <ul style="list-style-type: none"> <li>► Have the ABS system checked at an authorized smart center immediately.</li> </ul>
<p> (USA only)   (Canada only)</p> <p>The ABS indicator lamp illuminates together with the brake warning lamp while the engine is running.</p>	<p>The ABS system fails.</p> <ul style="list-style-type: none"> <li>► Stop the vehicle immediately in a safe location.</li> <li>► Do <b>not</b> continue to drive.</li> <li>► Turn off the engine.</li> <li>► Engage the parking brake when leaving the vehicle.</li> <li>► Contact Roadside Assistance or an authorized smart center.</li> </ul>





 **WARNING**

When the ABS system is malfunctioning, the wheels may lock during hard braking, reducing steering capability and extending the braking distance.

When the ABS is switched off due to a malfunction, the ESP® is also switched off. The basic driving and braking functions are still available.

The risk of your vehicle skidding is then increased in certain situations. You should therefore always adapt your speed and driving style to the prevailing road and weather conditions.

>> Practical hints.

Problem	Possible causes/consequences and ► Solutions
 (USA only)  (Canada only) The brake warning lamp illuminates while the engine is running.	You are driving with the parking brake engaged. ► Release the parking brake.  The brake circuit fails or the brake fluid level in the brake fluid reservoir is too low. ► Stop the vehicle immediately in a safe location. ► Do <b>not</b> continue to drive. ► Turn off the engine. ► Do not add brake fluid as this will not solve the problem. ► Engage the parking brake when leaving the vehicle. ► Contact Roadside Assistance or an authorized smart center.
 (USA only)  (Canada only) The brake warning lamp illuminates together with the ABS indicator lamp while the engine is running.	The ABS system has failed. ► Stop the vehicle immediately in a safe location. ► Do <b>not</b> continue to drive. ► Turn off the engine. ► Engage the parking brake when leaving the vehicle. ► Contact Roadside Assistance or an authorized smart center.



 **WARNING**

Driving with the brake warning lamp illuminated can result in an accident. Have your brake system checked immediately if the brake warning lamp stays on.



Do not add brake fluid before checking the brake system.

- !** If you find that the brake fluid in the brake fluid reservoir has fallen to the minimum mark or below, have the brake system checked for brake pad thickness and leaks immediately. Contact an authorized smart center immediately. Do not add brake fluid as this will not solve the problem.

## Safety systems

Problem	Possible causes/consequences and ► Solutions
 The seat belt telltale illuminates constantly for a maximum of 6 seconds after starting the engine.	Regardless of whether the seat belt is fastened or not, the seat belt telltale always comes on and remains lit for 6 seconds after starting the engine. <ul style="list-style-type: none"> <li>► Fasten your seat belts.</li> </ul>
 The seat belt telltale illuminates constantly. An additional warning chime sounds for a maximum of 6 seconds after starting the engine.	The driver's seat belt is unfastened. <ul style="list-style-type: none"> <li>► Fasten your seat belts.</li> </ul>
 The seat belt telltale flashes with increasing frequency of a warning chime for a maximum of 60 seconds.	The vehicle speed once exceeds 15 mph (25 km/h), and both the driver's and passenger seat belt are unfastened. <ul style="list-style-type: none"> <li>► Fasten your seat belts.</li> </ul> If the driver's or the passenger seat belt remains unfastened after 60 seconds, the warning chime stops sounding. The seat belt telltale stops flashing but continues to be illuminated. The seat belt telltale will only go out if both the driver's and the passenger seat belt (with the passenger seat occupied) are fastened, or the vehicle is standing still and a door is opened.

>> Practical hints.

Problem	Possible causes/consequences and ► Solutions
 Scenario 1: The SRS indicator lamp illuminates when the ignition is switched on and goes out after a maximum of 4 seconds.	The subsequent self check of the safety systems detected no malfunction. The supplemental restraint system is operational.
 Scenario 2: The SRS indicator lamp illuminates when the ignition is switched on and goes out after a maximum of 4 seconds for approximately 1 second, then it comes on again and stays on.	There is a malfunction in the supplemental restraint systems. The air bags or Emergency Tensioning Devices could deploy unexpectedly or fail to deploy in an accident. <ul style="list-style-type: none"> <li>► Do not sit on the passenger seat; this applies particularly to children.</li> <li>► Have the system checked at an authorized smart center.</li> </ul>

 **WARNING**

If the SRS indicator lamp does not come on when you switch on the ignition or does not go out again after a few seconds once the engine is running or comes on again, the supplemental restraint systems are malfunctioning.



In the event that a malfunction of the SRS is indicated as described in scenario 2, the SRS may not be operational. For your safety, we strongly recommend that you contact an authorized smart center immediately to have the system checked; A malfunctioning SRS system may not deploy when needed in an accident resulting in serious or fatal injury, or it might deploy unexpectedly and unnecessarily which could result in an accident and/or injury to you or to others.

**!** If the SRS indicator lamp comes on while driving, have the system checked at an authorized smart center immediately.

It is possible that the air bag and the emergency tensioning device could be activated unintentionally or will not function in the event of an accident.

**i** Information on the operating principle of the air bags can be found in the "Safety" section (► page 33).





Problem	Possible causes/consequences and ► Solutions
 The ESP® warning lamp flashes while driving.	The ESP® has engaged because of detected traction loss in at least one tire. <ul style="list-style-type: none"> <li>▶ When driving off, apply as little throttle as possible.</li> <li>▶ While driving, ease up on the accelerator pedal.</li> <li>▶ Adapt your speed and driving to the prevailing road and weather conditions.</li> </ul>
 The ESP® warning lamp illuminates continuously while the engine is running.	The ESP® is not operational due to a system failure. <ul style="list-style-type: none"> <li>▶ Have the system checked at an authorized smart center.</li> </ul> The ESP® is not available. <ul style="list-style-type: none"> <li>▶ Have the system checked at an authorized smart center.</li> </ul>

 **WARNING**

When the ESP® warning lamp is illuminated continuously, the ESP® is not available or not operational due to a system failure.

Adapt your speed and driving to the prevailing road conditions and the non-operating status of the ESP®.

-  It may be possible to clear a system failure by restarting the engine.
  - ▶ Restart the engine.
    - If the warning lamp still does not go out, have the system checked at an authorized smart center immediately.
-  More information on the ESP® can be found in the “Safety” section (▷ page 46).

Problem	Possible causes/consequences and ► Solutions
 The yellow EPS* warning lamp illuminates while the engine is running.	The Electronic Power Steering (EPS)* is not available. <ul style="list-style-type: none"> <li>▶ Have the EPS* checked at an authorized smart center immediately.</li> </ul>

 **WARNING**

When the EPS\* is not available a higher degree of effort is necessary to steer the vehicle. Have the system checked at an authorized smart center.

**>> Practical hints.**



\* optional







## Vehicle

Problem	Possible causes/consequences and ► Solutions
 The battery indicator lamp illuminates while driving or does not go out after the engine is started.	<p>The alternator is malfunctioning. The battery is no longer charged.</p> <ul style="list-style-type: none"> <li>► Stop the vehicle immediately in a safe location.</li> <li>► Do <b>not</b> continue to drive.</li> <li>► Turn off the engine.</li> <li>► Engage the parking brake when leaving the vehicle.</li> <li>► Contact Roadside Assistance or an authorized smart center.</li> </ul> <p>The poly-V-belt is broken. The battery is no longer charged.</p> <ul style="list-style-type: none"> <li>► Stop the vehicle immediately in a safe location.</li> <li>► Do <b>not</b> continue to drive.</li> <li>► Turn off the engine.</li> <li>► Engage the parking brake when leaving the vehicle.</li> <li>► Contact Roadside Assistance or an authorized smart center.</li> </ul>

&gt;&gt; Practical hints.

**!** Among other possible causes, the poly-V-belt could be broken. Do not continue to drive. Otherwise, the engine will overheat due to an inoperative water pump which may result in damage to the engine.

Problem	Possible causes/consequences and ► Solutions
  The main service symbol illuminates together with the flashing care service symbol after the engine is started.  In addition, the transmission position indicator flashes.	<p>The gearbox is malfunctioning.</p> <ul style="list-style-type: none"> <li>► Contact Roadside Assistance or an authorized smart center.</li> </ul>

Problem	Possible causes/consequences and ► Solutions
 The high-beam headlamp indicator lamp does not illuminate when the high-beam headlamps are switched on or when using the high-beam flasher.	The high-beam headlamp indicator lamp has failed. <ul style="list-style-type: none"> <li>► Have the high-beam headlamp indicator lamp checked at an authorized smart center.</li> </ul>
 The low-beam headlamp indicator lamp does not illuminate when the low-beam headlamps are switched on.	The low-beam headlamp indicator lamp has failed. <ul style="list-style-type: none"> <li>► Have the low-beam headlamp indicator lamp checked at an authorized smart center.</li> </ul>
  The turn signal indicator lamp(s) do(es) not illuminate when the ignition is switched on and the corresponding turn signal is switched on or the hazard warning flasher is switched on.	The turn signal indicator lamp(s) has (have) failed. <ul style="list-style-type: none"> <li>► Have the turn signal indicator lamp(s) checked at an authorized smart center.</li> </ul>
  The turn signal indicator lamp(s) flashes at double frequency.	One of the turn signals is malfunctioning. <ul style="list-style-type: none"> <li>► Replace the bulb as soon as possible (► page 179).</li> <li>or</li> <li>► Have the turn signal checked at an authorized smart center as soon as possible.</li> </ul>
 The fuel cap indicator lamp comes on when the engine is running.	The fuel cap may not be closed properly or the fuel system may be leaky. <ul style="list-style-type: none"> <li>► Check the fuel cap (► page 116).</li> <li>► <b>If it is not closed properly:</b> Close the fuel cap.</li> <li>► <b>If it is closed properly:</b> Have the fuel system checked at an authorized smart center.</li> </ul>

## Engine

Problem	Possible causes/consequences and ► Solutions
 The red coolant temperature warning lamp illuminates while the engine is running.	<p>The coolant is too hot.</p> <ul style="list-style-type: none"> <li>► Stop the vehicle immediately in a safe location.</li> <li>► Do <b>not</b> continue to drive.</li> <li>► Turn off the engine.</li> <li>► Engage the parking brake when leaving the vehicle.</li> <li>► Contact Roadside Assistance or an authorized smart center.</li> </ul> <p>The coolant level has fallen below the marking bar on the coolant reservoir (▷ page 122).</p> <ul style="list-style-type: none"> <li>► Add coolant as required.</li> <li>► Have the coolant system checked for leaks at an authorized smart center.</li> </ul>

 **WARNING**

Driving when your engine is overheated can cause some fluids which may have leaked into the engine compartment to catch fire. You could be seriously burned.



Steam from an overheated engine can cause serious burns which can occur just by opening the engine hood. Stay away from the engine if you see or hear steam coming from it.

Stop the vehicle in a safe location away from other traffic. Turn off the engine, get out of the vehicle and do not stand near the vehicle until the engine has cooled down.

**!** Among other possible causes, the poly-V-belt could be broken. Do not continue to drive. Otherwise, the engine will overheat due to an inoperative water pump which may result in damage to the engine.



Problem	Possible causes/consequences and ► Solutions
 The engine malfunction indicator lamp illuminates while driving.	<p>There is a malfunction in the system.</p> <ul style="list-style-type: none"> <li>► Have the vehicle checked at an authorized smart center immediately.</li> </ul>

**i** Some states may by law require you to visit a workshop as soon as the engine malfunction indicator lamp comes on. Check local requirements.

Problem	Possible causes/consequences and ► Solutions
 The engine oil pressure indicator lamp illuminates while driving.	<p>The engine oil pressure is low.</p> <ul style="list-style-type: none"> <li>► Stop the vehicle immediately in a safe location.</li> <li>► Do <b>not</b> continue to drive.</li> <li>► Turn off the engine.</li> <li>► Engage the parking brake when leaving the vehicle.</li> <li>► Contact Roadside Assistance or an authorized smart center.</li> </ul>
 The engine oil pressure indicator lamp goes out before the engine starts.	<p>The engine oil pressure indicator lamp has failed.</p> <ul style="list-style-type: none"> <li>► Check the engine oil level.</li> <li>► Have the system checked at an authorized smart center.</li> </ul>

**!** The engine oil pressure indicator lamp should not be ignored. Extended driving with the engine oil pressure indicator lamp illuminated could result in serious engine damage that is not covered by the smart Limited Warranty.

#### Tire Pressure Monitoring System (TPMS)\*

Problem	Possible causes/consequences and ► Solutions
 The yellow combination low tire pressure/TPMS malfunction telltale illuminates continuously.	<p>The TPMS detects a loss of pressure in at least one tire.</p> <ul style="list-style-type: none"> <li>► Carefully bring the vehicle to a halt, avoiding abrupt steering and braking maneuvers. Observe the traffic situation around you.</li> <li>► Check and correct tire inflation pressure as required (&gt; page 126).</li> </ul> <p>If the tire inflation pressure in the respective tire(s) has (have) been corrected, the combination low tire pressure/TPMS malfunction telltale goes out after a few minutes of driving. See also "Restarting the TPMS" (&gt; page 129).</p>
 The combination low tire pressure/TPMS malfunction telltale flashes 60 seconds and then stays illuminated.	<p>There is a malfunction in the TPMS.</p> <ul style="list-style-type: none"> <li>► Have the TPMS checked at an authorized smart center.</li> </ul> <p>After the malfunction has been remedied the combination low tire pressure/TPMS malfunction telltale goes out after a few minutes of driving.</p>

**>> Practical hints.**

\* optional

 **WARNING**

Each tire should be checked monthly when cold and inflated to the inflation pressure recommended by the vehicle manufacturer on the Tire and Loading Information placard. If your vehicle has tires of a different size than the size indicated on the Tire and Loading Information placard, you should determine the proper tire inflation pressure for those tires.

As an added safety feature, your vehicle has been equipped with a tire pressure monitoring system (TPMS) that illuminates a low tire pressure telltale when one or more of your tires is significantly underinflated.

Accordingly, when the low tire pressure telltale illuminates, you should stop and check your tires as soon as possible, and inflate them to the proper pressure. Driving on a significantly underinflated tire causes the tire to overheat and can lead to tire failure.



Underinflation also reduces fuel efficiency and tire tread life, and may affect the vehicle's handling and stopping ability. Please note that the TPMS is not a substitute for proper tire maintenance, and it is the driver's responsibility to maintain correct tire pressure, even if underinflation has not reached the level to trigger illumination of the TPMS low tire pressure telltale.

Your vehicle has also been equipped with a TPMS malfunction indicator to indicate when the system is not operating properly. The TPMS malfunction indicator is combined with the low tire pressure telltale. When the system detects a malfunction, the telltale will flash for approximately 1 minute and then remain continuously illuminated.

This sequence will continue upon subsequent vehicle start-ups as long as the malfunction exists. When the malfunction indicator is illuminated, the system may not be able to detect or signal low tire pressure as intended.

TPMS malfunctions may occur for a variety of reasons, including the installation of incompatible replacement or alternate tires or wheels on the vehicle that prevent the TPMS from functioning properly. Always check the TPMS malfunction telltale after replacing one or more tires or wheels on your vehicle to ensure that the replacement or alternate tires and wheels allow the TPMS to continue to function properly.

### Warning and indicator lamps in the overhead control panel

Problem	Possible causes/consequences and ► Solutions
 <b>PASS AIR BAG OFF</b> The passenger front air bag off indicator lamp illuminates and remains illuminated with the weight of a typical adult or someone larger than a small individual on the passenger seat.	There is a malfunction in the system. ► Have the system checked at an authorized smart center.
 <b>PASS AIR BAG OFF</b> The passenger front air bag off indicator lamp does not illuminate or remains out with the weight of a typical 12-month-old child in a standard child restraint or less on the passenger seat	There is a malfunction in the system. ► Have the system checked at an authorized smart center.

#### **WARNING**

If the  **PASS AIR BAG OFF** indicator lamp illuminates and remains illuminated with the weight of a typical adult or someone larger than a small individual on the passenger seat, do not have any passenger use the passenger seat until the system has been repaired.

#### **WARNING**

If the  **PASS AIR BAG OFF** indicator lamp does not illuminate or remains out with the weight of a typical 12-month-old child in a standard child restraint or less on the passenger seat, do not transport a child on the passenger seat until the system has been repaired.

>> Practical hints.



Engine	
Problem	Possible causes/consequences and ► Solutions
The engine does not start.	<ul style="list-style-type: none"> <li>► Check if               <ul style="list-style-type: none"> <li>• the gear selector lever is in park position <b>P</b></li> <li>• the brake pedal has been depressed</li> <li>• the transmission position indicator is on <b>P</b> or <b>N</b></li> </ul> </li> </ul>
The engine does not start within 4 seconds.	<ul style="list-style-type: none"> <li>► Wait for a few seconds.</li> <li>► Repeat the starting procedure.</li> </ul> <p>Remember that extended starting attempts can drain the vehicle battery.</p>
The engine does not start after several starting attempts.	<ul style="list-style-type: none"> <li>► Engage the parking brake when leaving the vehicle.</li> <li>► Contact Roadside Assistance or an authorized smart center.</li> </ul>

>> Practical hints.

Loss of key	
Problem	Possible causes/consequences and ► Solutions
You lose a key.	<ul style="list-style-type: none"> <li>► Have the key deactivated at an authorized smart center.</li> <li>► Report the loss of the key to your car insurance company immediately.</li> <li>► If necessary, have the mechanical lock replaced.</li> </ul> <p>Your authorized smart center will be glad to supply you with a replacement following an identity check.</p>



## Acoustic warning signals

Problem	Possible causes/consequences and ► Solutions
Once the anti-theft warning system* has been armed, a visual and audible alarm is triggered.	<p>The alarm is triggered when</p> <ul style="list-style-type: none"> <li>• someone opens a door or the tailgate</li> <li>• the driver's door is unlocked with the key (▷ page 176)</li> <li>• the vehicle's interior is entered</li> <li>• there is motion inside the vehicle</li> <li>• the vehicle is raised</li> </ul> <p>To cancel the alarm:</p> <ul style="list-style-type: none"> <li>► Insert the key in the starter switch.</li> <li>► Turn the key to starter switch position <b>1</b>.</li> </ul> <p>or</p> <ul style="list-style-type: none"> <li>► Press button  or  on the key.</li> </ul>
A warning signal sounds.	<p>The door is opened while a gear is engaged with the engine running and neither the brake nor accelerator pedals are depressed.</p> <ul style="list-style-type: none"> <li>► Close the driver's and passenger door.</li> <li>► Move the gear selector lever to park position <b>P</b>.</li> </ul> <p>or</p> <ul style="list-style-type: none"> <li>► Turn off the engine.</li> </ul> <p>You open the driver's door with the key in starter switch position <b>0</b> to remind you not to leave the key in the vehicle.</p> <ul style="list-style-type: none"> <li>► Close the driver's door.</li> </ul> <p>or</p> <ul style="list-style-type: none"> <li>► Remove the key from the starter switch.</li> </ul>
A warning signal sounds.	<p>The seat belts are not fastened when the engine is started. For details, see seat belt telltale (▷ page 165).</p> <ul style="list-style-type: none"> <li>► Fasten your seat belts.</li> </ul>

**>> Practical hints.**

\* optional

Problem	Possible causes/consequences and ► Solutions
A warning signal sounds when parking.	<p>You have not engaged the parking brake before releasing the brake pedal, turning off the engine, and switching off the ignition.</p> <ul style="list-style-type: none"> <li>► Switch on the ignition to deactivate the acoustic warning.</li> <li>► Engage the parking brake.</li> <li>► Make sure the gear selector lever is in park position <b>P</b>.</li> <li>► Turn the key to starter switch position <b>0</b>.</li> <li>► Remove the key from the starter switch.</li> </ul> <p>For safety, it is important that you perform the parking procedure as described (▷ page 79).</p>
You can hear a continuous noise from the front axle when braking.	<p>The vehicle is equipped with a mechanical/acoustic brake pad indicator.</p> <ul style="list-style-type: none"> <li>► Have the brake pads checked at an authorized smart center.</li> </ul>

### Unlocking/locking manually

#### Unlocking the vehicle

You can unlock the driver's door and the fuel filler flap by unlocking the driver's door using the key. The lock cylinder is fitted with a cap.

- Press button  on the key.  
The anti-theft warning system\* is disarmed.

- i** If the transmitter battery in the key is discharged, the anti-theft warning system\* can no longer be disarmed with button  on the key.

For replacing the transmitter battery (▷ page 177).

Unlocking the vehicle with the key and opening a door or the tailgate will trigger the anti-theft warning system\* (▷ page 48).

To cancel the alarm:

- Insert the key in the starter switch.
- Turn the key to starter switch position **1**.

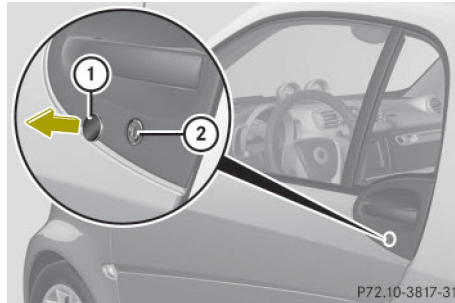

P72.10-3817-31

- Remove cap **1** from lock cylinder **2**.
- Unlock the driver's door.  
The driver's door and the fuel filler flap are unlocked.

- i** To unlock the vehicle centrally press the central unlocking switch in the upper center console (▷ page 26).

#### Locking the vehicle

If you can no longer lock the vehicle using the remote control and you do not have a spare transmitter battery at hand, please proceed as follows:

\* optional

- ▶ Open the driver's door.
- ▶ Press the central locking switch (> page 54).  
The indicator lamp on the central locking switch comes on, when the starter switch is in position **1**.  
The indicator lamp on the central locking switch flashes, when the starter switch is in position **0**.
- ▶ Remove the key from the starter switch, take it with you, and close all doors. The vehicle is now locked and the anti-theft warning system\* is armed.

### Closing the rear soft top

If the rear soft top does not lock properly after being closed, proceed as follows:

- ▶ Stop the vehicle in a safe location.
- ▶ Engage the parking brake.
- ▶ Make sure the key is in starter switch position **1**.
- ▶ Fold up the rear soft top completely. The rear soft top stops in the unlocked position.
- ▶ Within one minute, press and hold symbol  on the retractable soft top switch for 15 seconds twice. The rear soft top closes the locking hooks.
- ▶ Close the retractable soft top completely.
- ▶ Have the rear soft top checked at an authorized smart center.

### Replacing transmitter battery

#### Notes

The remote control's transmitter battery is almost spent when the turn signals flash rapidly nine times in a row when locking the vehicle.

\* optional

**i** If you do not replace the transmitter battery, after about 100 more times you will no longer be able to lock or unlock the vehicle using the remote control.

- ▶ Replace the transmitter battery.

or

- ▶ Have the transmitter battery replaced at an authorized smart center.

#### **WARNING**

Batteries contain poisonous and corrosive substances. Therefore keep the batteries out of reach of children.

If a battery is swallowed, seek medical help immediately.

Batteries contain materials that can harm the environment if disposed of improperly. Recycling of batteries is the preferred method of disposal. Many states/provinces require sellers of batteries to accept old batteries for recycling.

### Replacing battery

Replacement battery: CR 2016 button cell

- !** Replace the remote control's transmitter battery every two years at the latest. Otherwise there is a danger of leakage. The remote control could be damaged.

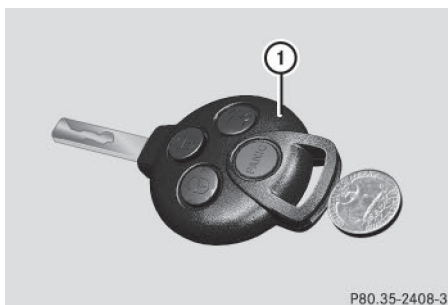

P80.35-2408-31

>>> Practical hints.

- ▶ Insert a suitable object such as a coin into the slot at the eyelet of the key housing.
- ▶ Carefully turn the coin until key housing top half ① is unlatched.
- ▶ Open key housing top half ① to the side.

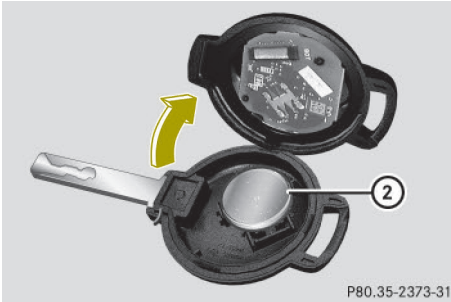

- ▶ Remove transmitter battery ② from the board.

**!** Check the polarity when inserting the new transmitter battery. You could otherwise damage parts of the electrical system. When inserting the batteries, make sure they are clean and free of lint.

- ▶ Insert the new transmitter battery.
- ▶ Press both halves of the key housing together again.
- ▶ Check the operation of the remote control.

## Replacing bulbs

### About replacing bulbs

Safe vehicle operation depends on proper exterior lighting and signaling. It is therefore essential that all bulbs and lamp assemblies are in good working order at all times.

Correct headlamp adjustment is extremely important. Have headlamps checked and readjusted at regular intervals and when a bulb has been replaced. Contact an authorized smart center for headlamp adjustment.

### **⚠ WARNING**

Bulbs and bulb sockets can be very hot. Allow the lamp to cool down before changing a bulb. Otherwise you could be burned if you touch them.

Keep bulbs out of the reach of children.

Halogen lamps contain pressurized gas. A bulb can explode if you:

- touch or move it when hot
- drop the bulb
- scratch the bulb

Wear eye and hand protection.

- i** If the headlamps or front fog lamps\* are fogged up on the inside as a result of high humidity, driving the vehicle a distance with the lights on should clear up the fogging.

Notes on bulb replacement:

- Only use bulbs of the same type and with the specified watt rating.
- Switch the lights off before replacing a bulb to prevent short circuits.
- Always use a clean lint-free cloth when handling bulbs.
- Your hands should be dry and free of oil and grease.
- Avoid touching the glass of the bulb with bare fingers.
- If the newly installed bulb does not come on, contact an authorized smart center.
- Have the bulbs for the front fog lamps\* and the LED daytime running lamps\* replaced at an authorized smart center.

\* optional

Overview bulbs

Front lamps

Headlamp

Type

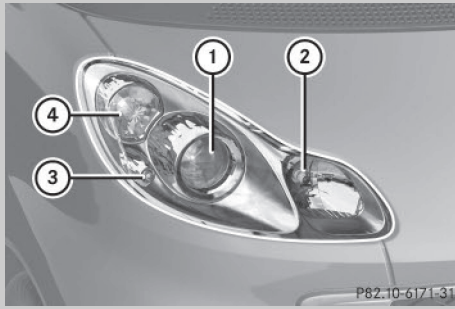

- ① Low-beam headlamp  
H7 (55 W)
- ② High-beam headlamp  
H7 (55 W)
- ③ Parking and side marker lamp  
WY 5 W
- ④ Turn signal lamp  
2357 A

Front fog lamp\*

Type

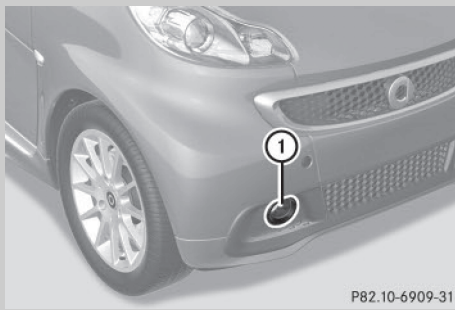

- ① Front fog lamp  
H 11

Side turn signal lamp

Type

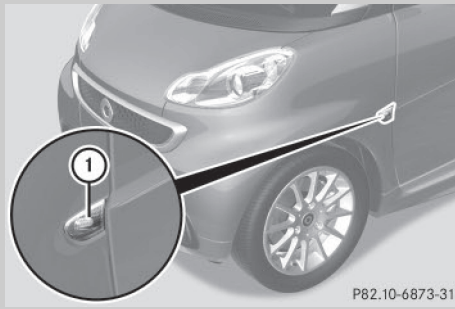

- ① Side turn signal lamp  
WY 5 W

>> Practical hints.

\* optional

Rear lamps	
Tail lamp unit	Type
<p>P82.10-6394-31</p>	<ul style="list-style-type: none"> <li>① Brake lamp/tail lamp/turn signal lamp/side marker lamp 12 V 21/5 W</li> <li>② Reflector -</li> <li>③ Backup lamp 12 V 21 W</li> </ul>
License plate lamps	Type
<p>P82.10-6874-31</p>	<ul style="list-style-type: none"> <li>① License plate lamps C 5 W</li> </ul>
High-mounted brake lamp	Type
<p>P82.10-6182-31</p>	<ul style="list-style-type: none"> <li>① High-mounted brake lamp W 16 W</li> </ul>

### Replacing bulbs for front lamps

Before you start to replace a bulb for a front lamp, do the following first:

- ▶ Turn the exterior lamp switch to position **0** (▷ page 64).
- ▶ Switch off the ignition.
- ▶ Open the service flap (▷ page 120).

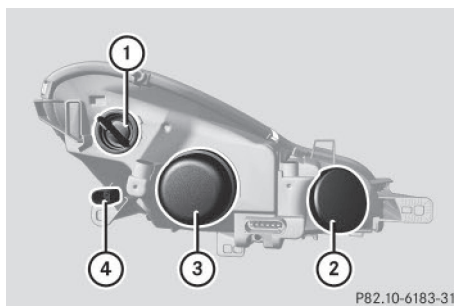

Left headlamp, (right headlamp in reverse)

### Parking and side marker lamp bulb

▶ **Removing:**

Driver's side: Turn bulb socket ④ toward the outside.

Passenger side: Turn bulb socket ④ toward the outside.

- ▶ Pull bulb socket ④ out of the headlamp housing.
- ▶ Pull the bulb out of bulb socket ④.

▶ **Installing:** Insert the new bulb into bulb socket ④.

▶ Insert bulb socket ④ into the headlamp housing.

▶ Driver side: Turn bulb socket ④ toward the inside.

Passenger side: Turn bulb socket ④ toward the inside.

### Low-beam headlamp bulb

▶ **Removing:** Take off low-beam headlamp cover ③.

▶ Detach the electrical connector.

▶ Bend the retainer spring end down and forward until it unclips. Fold the retainer spring back.

▶ Pull the bulb out of the headlamp housing.

▶ **Installing:** Insert the new bulb into the headlamp housing.

▶ Fold the retainer spring forward.

▶ Bend the retainer spring end forward then up and back to clip in.

▶ Attach the electrical connector.

▶ Reinstall low-beam headlamp cover ③.

### High-beam headlamp bulb

▶ **Removing:** Take off high-beam headlamp cover ②.

▶ Detach the electrical connector.

▶ Tilt the bulb socket down and pull it out.

▶ Pull the bulb out of the bulb socket.

▶ **Installing:** Insert the new bulb into the bulb socket.

▶ Fit the bulb so that the retaining lug of the base plate is pointing up.

▶ Press the bulb into the bulb socket until it is fully engaged.

▶ Attach the electrical connector.

▶ Reinstall high-beam headlamp cover ②.

### Front turn signal lamp bulb

▶ **Removing:** Turn bulb socket ① counterclockwise by a quarter of turn and pull it out of the headlamp housing.

▶ Press gently onto the bulb and turn it counterclockwise.

▶ Pull the bulb out of bulb socket ①.

▶ **Installing:** Insert the new bulb into bulb socket ①.

▶ Press gently onto the bulb and turn it clockwise.

▶ Insert bulb socket ① into the headlamp housing.

>> Practical hints.

The arrow on bulb socket ① must be in line with the line on the headlamp housing.

- ▶ Turn bulb socket ① clockwise by a quarter of turn.

### Side turn signal lamp bulb

- ▶ **Removing:** Open the door on the corresponding side.

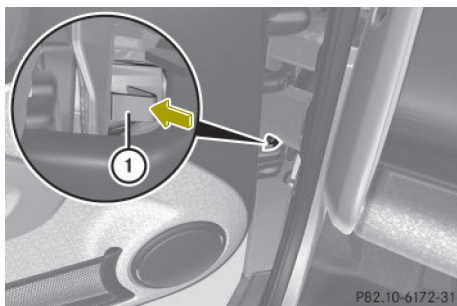

>> Practical hints.

- ▶ Press on retaining lug ① in the direction of the arrow until the side turn signal lamp housing disengages.
- ▶ Close the door.
- ▶ Use a suitable tool to loosen the side turn signal lamp housing from the fender.
- ▶ Turn the bulb socket counterclockwise and pull it out of the side turn signal lamp housing.
- ▶ Pull the bulb out of the bulb socket.
- ▶ **Installing:** Insert the new bulb into the bulb socket.
- ▶ Insert the bulb socket into the side turn signal lamp housing and turn the bulb socket clockwise.
- ▶ Fit the side turn signal lamp housing onto the fender.
- ▶ Press gently onto the side turn signal lamp housing.

The side turn signal lamp housing must audibly engage.

### Replacing bulbs for rear lamps

Before you start to replace a bulb for a rear lamp, do the following first:

- ▶ Turn exterior lamp switch to position **0** (> page 64).
- ▶ Switch off the ignition.

### Tail lamp unit

#### ▶ **Removing:**

- Coupé: Open the upper tailgate.
- ▶ Open the lower tailgate.
- ▶ Cabriolet: Open the rear soft top (> page 73).
- ▶ Remove the side cover in the cargo compartment on the corresponding side.
- ▶ Fold the damping material forward, if necessary.

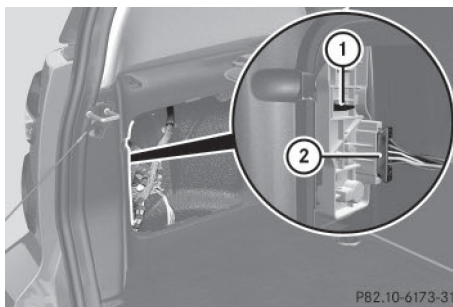

Left bulb carrier illustrated as example

① Retaining tab

② Electrical connector

- ▶ Press retaining tab ① in the center of the bulb carrier upwards.
- ▶ Pull the bulb carrier out of the tail lamp housing.



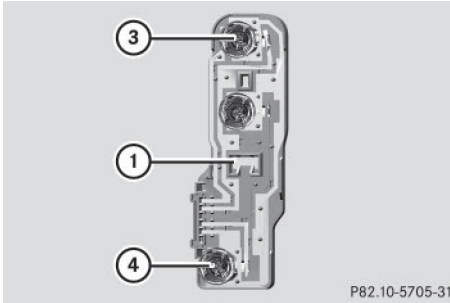

Left bulb carrier with bulb sockets (right bulb carrier in reverse)

- ① Retaining tab
- ③ Brake, tail, turn signal and side marker lamp bulb
- ④ Backup lamp bulb
- ▶ Depending on which bulb needs to be replaced, press gently onto bulb ③ or ④ and turn it counterclockwise.
- ▶ Pull the bulb out of the bulb socket.
- ▶ **Installing:** Insert the new bulb into the bulb socket.
- ▶ Press gently onto the bulb and turn it clockwise until it engages.
- ▶ Insert the bulb carrier into the tail lamp housing.
- ▶ Press gently onto the bulb carrier. Let retaining tab ① engage.
- ▶ Fold the damping material backward, if necessary.
- ▶ Reinstall the side cover in the cargo compartment.

### High-mounted brake lamp

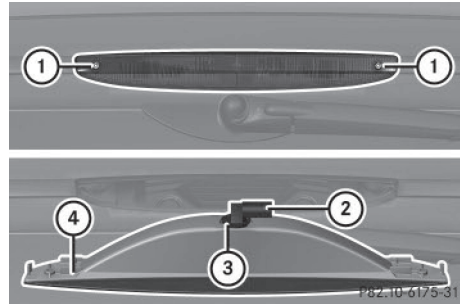

- ▶ **Removing:** Unscrew retaining screws ①.
- ▶ Remove high-mounted brake lamp ④.
- ▶ Detach electrical connector ② from bulb socket ③.
- ▶ Turn the bulb counterclockwise and pull it out of its socket.
- ▶ **Installing:** Install in the reverse order.

### License plate lamps

#### WARNING

High outside temperature, stop-and-go traffic, driving on long uphill grades, or driving at high engine speed may increase the temperature in the engine compartment. Therefore the area around the air slots in the rear apron may be hot. Let the engine cool off before touching this area to prevent burns.

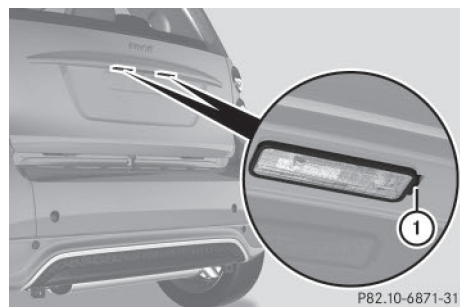

>> Practical hints.

- ▶ Use a suitable tool to loosen the corresponding license plate lamp unit at jacking point ①.
- ▶ Carefully unclip the license plate lamp unit.

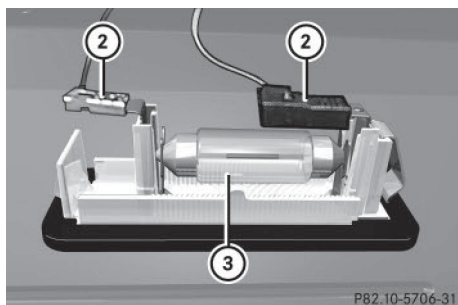

- ▶ Detach electrical connectors ②.
- ▶ Remove bulb ③.
- ▶ Insert the new bulb.
- ▶ Attach electrical connectors ②.
- ▶ Fit the license plate lamp unit on the right and press gently on the left. The license plate lamp unit must audibly engage.

### Replacing interior lighting lamps

A 12 V/10 W bulb is required.

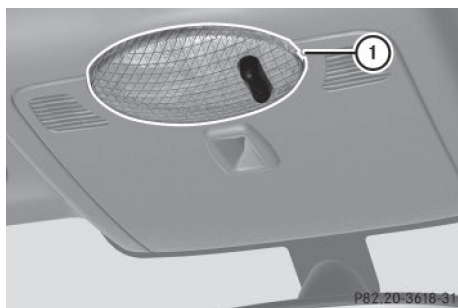

- ▶ **Removing:** Use a flat object to pry the lamp lens ① off from the passenger side.

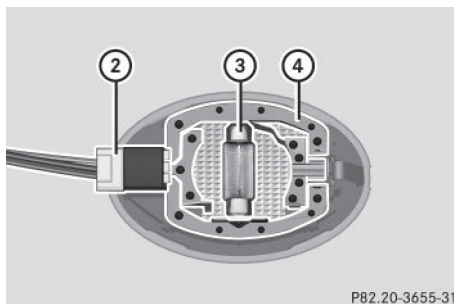

- ▶ Detach electrical connector ② from the interior lamp.
- ▶ Remove bulb ③ from mount ④.
- ▶ **Installing:** Insert the new bulb.
- ▶ Attach electrical connector ② to the interior lamp.
- ▶ Fit the lamp lens on the left in the opening and press gently on the right. The lamp lens must audibly engage.

### Replacing wiper blades

#### About replacing wiper blades

#### ⚠ WARNING

For safety reasons, switch off the wipers and remove the key from the starter switch before replacing a wiper blade. The windshield wipers could otherwise be set in motion and cause injury.

#### ⚠ WARNING

Wiper blades are components that are subject to wear and tear. Replace the wiper blades at least twice a year, preferably in the spring and fall. Otherwise the windows will not be properly wiped. As a result, you may not be able to observe surrounding traffic conditions and could cause an accident.

- ▶ **!** Hold on to the wiper when folding the wiper arm back. If released, the force of the impact from the windshield wiper

tioning spring could crack the windshield.

Do not allow the wiper arms to contact the windshield glass without a wiper blade inserted.

We recommend that you have this work carried out at an authorized smart center.

To ensure proper visibility

- it is vital that you have wiper blades that are in perfect shape
- clean the wiper blades regularly with a cleaning agent
- remove any tough dirt stains with a sponge or brush

### Windshield wiper blades

**!** Do not pull on the wiper blade inserts. They could tear.

### Removing

- ▶ Remove the key from the starter switch.

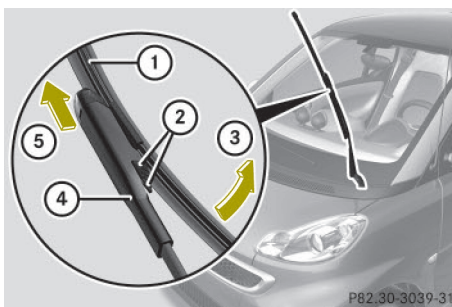

- ▶ Fold wiper arm (4) away from the windshield until it snaps into place.
- ▶ Press on retaining springs (2) on both sides of wiper blade (1).
- ▶ Fold wiper blade (1) away from wiper arm (4) in direction of arrow (3).
- ▶ Detach wiper blade (1) in direction of arrow (5).

### Installing

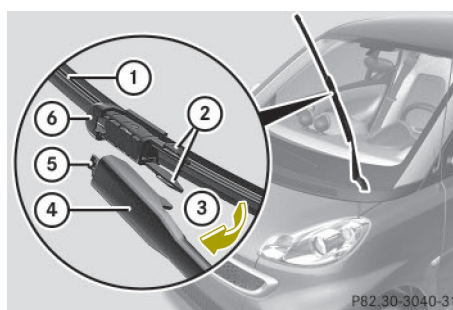

- ▶ With guide tab (5) sliding into opening (6), attach new wiper blade (1) onto the wiper arm.
- ▶ Fold wiper blade (1) towards the wiper arm in direction of arrow (3). Retaining springs (2) must audibly engage in attachment (4).
- ▶ Check whether wiper blade (1) is securely fastened.
- ▶ Fold the wiper arm backward to rest on the windshield. Make sure to hold on to the wiper when folding it back.

**!** Make sure the wiper blades are properly installed. Improperly installed wiper blades may cause windshield damage.

### Rear window wiper blade

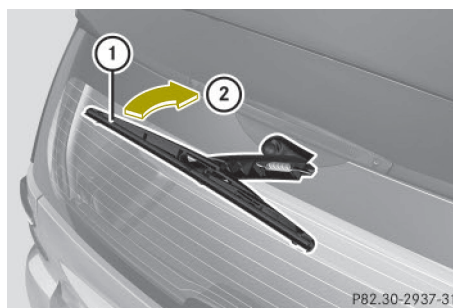

>> Practical hints.

- ▶ **Removing:** Fold the wiper arm away from the rear window until you feel it engage.
- ▶ Fold wiper blade ① away from the wiper arm in direction of arrow ② until it disengages from its mounting.
- ▶ Detach wiper blade ①.
- ▶ **Installing:** Push the new wiper blade onto the wiper arm until you feel it engage.
- ▶ Fold the wiper blade into a position parallel to the wiper arm.
- ▶ Fold the wiper arm backward to rest on the rear window.  
Make sure to hold on to the wiper when folding the wiper arm back.

**!** Make sure the wiper blade is properly installed. An improperly installed wiper blade may cause rear window damage.

#### Adjusting the washer jet nozzles

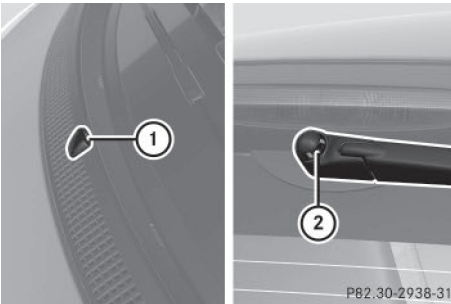

- ① Front washer jet nozzles
- ② Rear washer jet nozzles

- ▶ **Adjusting:** Use a needle to move washer jet nozzles ① or ② left, right, up, or down.
- i** Check the setting of the washer jet nozzles at regular intervals. The washer jet nozzles are correctly set when the water jet hits the windshield or the rear window approximately in the center.

## Flat tire

### Preparing the vehicle

Upon experiencing any type of problem with the vehicle's tires, switch on the hazard warning flasher, carefully slow down and exit the roadway in a cautious manner.

- ▶ Park the vehicle at a safe distance from moving traffic on a hard, flat surface when possible.
- ▶ Make sure the tire valve of the damaged tire is located below the horizontal axle of the wheel hub.
- ▶ Engage the parking brake.
- ▶ Turn the steering wheel so that the front wheels are in a straight ahead position.
- ▶ Move the gear selector lever to park position **P**.
- ▶ Turn off the engine.
- ▶ Remove the key from the starter switch and take the key with you.
- i** Open door only when conditions are safe to do so.
- ▶ Have any passenger exit the vehicle at a safe distance from the roadway.

### Using the tire repair kit

**!** Depending on the type of damage on the tire, the tire sealant could damage the sensor of the Tire Pressure Monitoring System (TPMS)\*. Such damage is not covered by the smart Limited Warranty.

When having the damaged tire replaced, also have the TPMS sensors\* checked for proper function. When the sensor is damaged, the TPMS\* will not function properly. The sensor must then be replaced at an authorized smart center as soon as possible.

- i** Depending on production date of your vehicle, it will be equipped with version 1 or version 2 of the tire repair kit. Please make sure to refer to the descrip-

\* optional

tion of the tire repair kit in your vehicle before sealing a tire.

The tire repair kit can be used to seal punctures of up to approximately 0.16 in (4 mm) on the tire tread.

The tire repair kit enables you to drive on the sealed tire to the nearest authorized smart center.

- ▶ You should have the sealed tire replaced at an authorized smart center.

#### **WARNING**

Take care not to allow the contents of the tire sealant to come in contact with hair, eyes or clothing. The tire sealant is harmful if inhaled, swallowed or absorbed through the skin - causes skin, eye and respiratory irritation. Wear gloves while using this product if they are available.

Any contact with eyes or skin should be flushed immediately with plenty of water.

If clothing comes in contact with the tire sealant, change clothing as soon as possible.

In case of allergic reaction or rash, consult a physician immediately.

#### **Notes**

- Small tire punctures, particularly those in the tread, can be sealed with the tire sealant.
- The tire sealant can be used in ambient temperatures from  $-4^{\circ}\text{F}$  ( $-20^{\circ}\text{C}$ ) to  $104^{\circ}\text{F}$  ( $+40^{\circ}\text{C}$ ).
- Do not remove any foreign objects such as nails or screws that have penetrated the tire.
- Do not use the tire sealant if the tire has been damaged by being driven when insufficiently inflated (e.g. bumps, cuts, cracks etc. on the tire).
- Allow escaped tire sealant to dry, then peel it off.

- Immediately wash all painted surfaces that came into contact with the tire sealant using a damp cloth.
- Avoid skin and eye contact with the tire sealant.
- Do not swallow the tire sealant.
- Allow the tire sealant that is inside the damaged tire to dry and dispose of together with the tire.
- Do not use the tire sealant after the expiration date has elapsed (see top of container).  
Instead, have it replaced at an authorized smart center.

#### **WARNING**

The tire sealant is a limited repair device. The tire sealant cannot be used for cuts or punctures larger than approximately 0.16 in (4 mm) and tire damage caused by driving with extremely low tire inflation pressure, or on a flat tire, or a damaged wheel.

Do not drive the vehicle under such circumstances.

If you are unsure of the condition of the tire or have any question whatsoever about its suitability for driving contact the nearest smart center for assistance or call Roadside Assistance.

#### **WARNING**

Please review the instructions below for using the tire repair kit. If you are not confident that you can competently follow the instructions for using this kit, do not use the kit, but instead call for Roadside Assistance.

#### **WARNING**

Keep the tire sealant out of reach of children. If swallowed, rinse mouth immediately with plenty of water and drink plenty of water.

Do not induce vomiting!

Consult a physician immediately.

Keep away from open flame, heat source or sparks. Do not smoke.

### Sealing a tire (Version 1)

- ▶ Take the tire repair kit from the passenger footwell (▷ page 158).
- ▶ Open the tire repair kit lid.

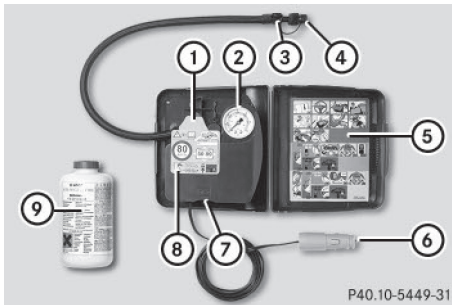

P40.10-5449-31

- >> Practical hints.
- ① Flange lid
  - ② Pressure gauge
  - ③ Vent screw
  - ④ Filler hose with stopper
  - ⑤ Operating instructions label
  - ⑥ Electrical plug
  - ⑦ Electric air pump switch
  - ⑧ Sticker
  - ⑨ Tire sealant container
- ▶ Remove sticker ⑧ from the tire repair kit.
  - ▶ Attach sticker ⑧ where it will be easily seen by the driver on the instrument cluster.
  - ▶ Unwind electrical plug ⑥ and filler hose ④.

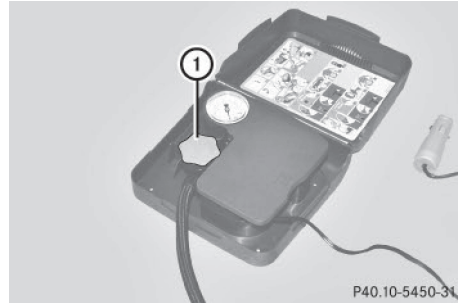

P40.10-5450-31

- ▶ Unscrew flange lid ①.
- ▶ Unscrew the lid of tire sealant container ⑨. Make sure not to damage the aluminum seal.

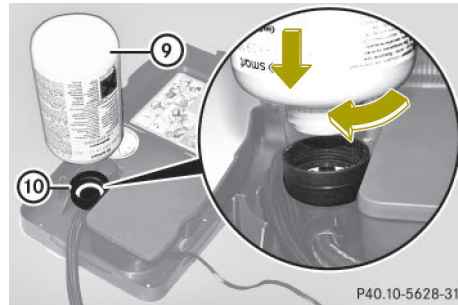

P40.10-5628-31

- ▶ Screw tire sealant container ⑨ onto flange ⑩.
- Make sure the container is threaded correctly onto the flange. This punctures the aluminum seal of the tire sealant container.
- ▶ Unscrew the valve cap from the tire valve of the damaged tire.
  - ▶ Close vent screw ③.
  - ▶ Pull off the stopper of filler hose ④.

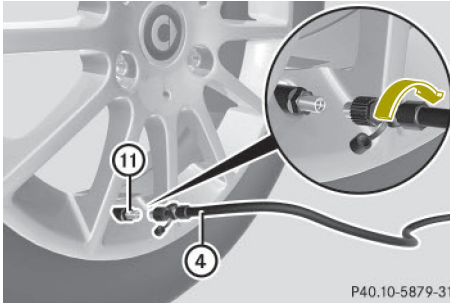

P40.10-5879-31

- ▶ Screw the end of filler hose (4) onto tire valve (11).
  - ▶ Insert electrical plug (6) into the auxiliary power outlet (▷ page 114).
  - ▶ Insert the key in the starter switch and turn it to position 1.
- i** The vehicle's battery is drained by use of the electric air pump. You should therefore keep the engine running – in the open air – while inflating the tire.

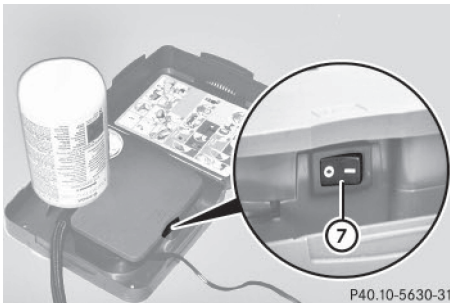

P40.10-5630-31

- ▶ Press **I** on electric air pump switch (7). The electric air pump is switched on and inflates the tire.
- i** First, the sealant is pumped into the tire. The pressure may briefly increase to a high value. This is normal and not an indication of a malfunction. Do not switch off the electric air pump.
- ▶ Let the electric air pump inflate the tire for a maximum of ten minutes. Pressure gauge (2) must display at least 180 kPa (1.8 bar, 26 psi).

**!** Do not operate the electric air pump longer than ten minutes without interruption. Otherwise it may overheat. You may operate the electrical air pump again after it has cooled off.

- ▶ If a tire inflation pressure of at least 180 kPa (1.8 bar, 26 psi) is not attained, turn off the electric air pump by pressing **0** on electric air pump switch (7).
- ▶ Unscrew the end of filler hose (4) from tire valve (11).
- ▶ After clearing the area around the vehicle of people and obstacles, drive vehicle back or forth very slowly approximately 30 ft (10 m). This serves to better distribute the tire sealant material inside the tire.
- ▶ Screw the end of filler hose (4) onto tire valve (11).
- ▶ Inflate the tire again.

**⚠ WARNING**

If a tire inflation pressure of 180 kPa (1.8 bar, 26 psi) is not attained, the tire is too severely damaged for the tire sealant to provide a reliable tire repair. In this case, the tire sealant cannot properly seal the tire. Do not drive the vehicle. Contact the nearest smart center for assistance or call Roadside Assistance.

- ▶ After attaining a tire inflation pressure of at least 180 kPa (1.8 bar, 26 psi), press **0** on electric air pump switch (7). The electric air pump is switched off.
- ▶ Turn the key in the starter switch to position **0**.
- ▶ Unscrew the end of filler hose (4) from tire valve (11).
- ▶ Plug filler hose with the stopper.
- ▶ Tire sealant container (9) remains screwed onto flange (10).

- ▶ Place the tire repair kit securely in the vehicle.
- ▶ Drive off immediately.  
The tire sealant will distribute itself evenly inside the tire.

 **WARNING**

Do not exceed vehicle speed of 50 mph (80 km/h). A tire sealant repair is not designed to operate at higher speeds.

The sticker must be attached on the instrument cluster where it will be easily seen by the driver.

Vehicle handling characteristics of a tire sealant repaired tire may change. Adapt your driving accordingly.

- ▶ After driving for about 1.8 miles (3 km) or ten minutes, stop and exit the vehicle taking all of the appropriate safety precautions.
- ▶ Take the tire repair kit from the vehicle.
- ▶ Screw the end of filler hose ④ onto tire valve ⑪.
- ▶ Check the tire inflation pressure using pressure gauge ②.

 **WARNING**

If tire inflation pressure has fallen below 130 kPa (1.3 bar, 19 psi) do not continue to drive the vehicle.

Park your vehicle safely away from the roadway and contact the nearest smart center or call Roadside Assistance.

Have the damaged tire replaced.

- ▶ If the tire inflation pressure is at least 130 kPa (1.3 bar, 19 psi), inflate or deflate the tire to correct tire inflation pressure (see Tire and Loading Information placard located on the driver's door B-pillar).
  - To increase the tire inflation pressure: Switch on the electric air pump.
  - To decrease the tire inflation pressure: Open vent screw ③. Recheck the

tire inflation pressure with the electric air pump's pressure gauge.

- ▶ After checking the tire inflation pressure, unscrew the end of filler hose ④ from tire valve ⑪.
- ▶ Screw the valve cap onto the tire valve.
- ▶ Plug filler hose with the stopper.
- ▶ Place the tire repair kit securely in the vehicle.

- ❗ The manufacturer is unable to guarantee that all tire punctures can be repaired with the tire repair kit, in particular cuts or perforations larger than approximately 0.16 in (4 mm) or away from the tire's tread. The manufacturer is not liable for damage sustained through improper use of the tire repair kit.

 **WARNING**

Follow recommended tire inflation pressures.

Do not underinflate tires. Underinflated tires wear excessively and/or unevenly, adversely affect handling and fuel economy, and are more likely to fail from being overheated.

Do not overinflate tires. Overinflated tires can adversely affect handling and ride comfort, wear unevenly, increase stopping distance, and result in sudden deflation (blowout) because they are more likely to become punctured or damaged by road debris, potholes etc.

Do not overload the tires by exceeding the specified load limit as indicated on the Tire and Loading Information placard on the driver's door B-pillar. Overloading the tires can overheat them, possibly causing a blowout. Overloading the tires can also result in handling or steering problems, or brake failure.



- ▶ Drive to the nearest authorized smart center, to have the damaged tire replaced.
- ▶ Contact an authorized smart center as soon as possible to obtain a new filler hose and a new tire sealant container.
- ▶ Bring used tire sealant materials to an authorized smart center for proper disposal.
- ▶ Replace your tire sealant container every 4 years. Replacement containers are available at any authorized smart center.

#### **WARNING**

After changing a tire, contact a smart center to make sure the bolts holding the wheel to the car are tight enough. Otherwise, the wheels could come off. Each bolt should be tightened to a torque of 81 lb-ft (110 Nm).

#### Sealing a tire (Version 2)

- ▶ Take the tire repair kit from the passenger footwell (> page 158).

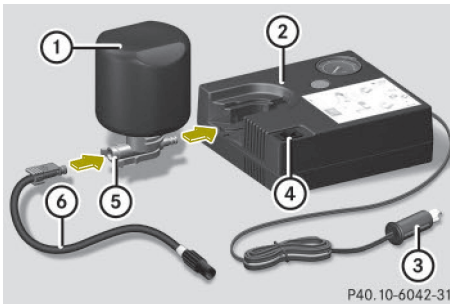

- ▶ Take electrical plug ③ and filler hose ⑥ from the bottom of the electric air pump housing.
- ▶ Engage the yellow plug of filler hose ⑥ in the opening in yellow closure cap ⑤.

- ▶ With the O-ring seals towards the electric air pump housing, insert yellow closure cap ⑤ into fixture ②.
- ▶ Push tire sealant container ① into fixture ② until both hooks of yellow closure cap ⑤ engage.

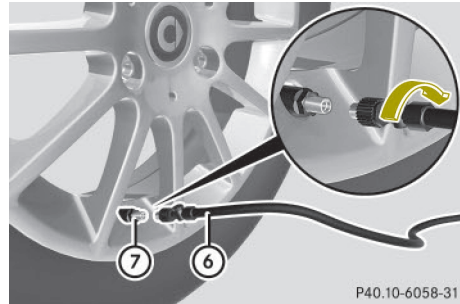

- ▶ Unscrew the valve cap from tire valve ⑦ of the damaged tire.
- ▶ Screw the end of filler hose ⑥ onto tire valve ⑦.
- ▶ Insert electrical plug ③ into the auxiliary power outlet (> page 114).
- ▶ Insert the key in the starter switch and turn it to position 1.

**i** The vehicle's battery is drained by use of the electric air pump. You should therefore keep the engine running – in the open air – while inflating the tire.

- ▶ Press **ON** on electric air pump switch ④. The electric air pump is switched on and inflates the tire.

**i** First, the sealant is pumped into the tire. The pressure may briefly increase to a high value. This is normal and not an indication of a malfunction. Do not switch off the electric air pump.

- ▶ Let the electric air pump inflate the tire for a maximum of ten minutes.

The pressure gauge must display at least 200 kpa (2.0 bar, 29 psi).

- ▶ **!** Do not operate the electric air pump longer than ten minutes without interruption. Otherwise it may overheat.

You may operate the electrical air pump again after it has cooled off.

- ▶ If a tire inflation pressure of at least 200 kPa (2.0 bar, 29 psi) is not attained, turn off the electric air pump by pressing **OFF** on electric air pump switch ④.
- ▶ Unscrew the end of filler hose ④ from tire valve ⑦.
- ▶ After clearing the area around the vehicle of people and obstacles, drive vehicle back or forth very slowly approximately 30 ft (10 m).

This serves to better distribute the tire sealant material inside the tire.

- ▶ Screw the end of filler hose ④ onto tire valve ⑦.
- ▶ Inflate the tire again.

#### ⚠ WARNING

If a tire inflation pressure of 200 kPa (2.0 bar, 29 psi) is not attained, the tire is too severely damaged for the tire sealant to provide a reliable tire repair.

In this case, the tire sealant cannot properly seal the tire.

Do not drive the vehicle.

Contact the nearest smart center for assistance or call Roadside Assistance.

- ▶ After attaining a tire inflation pressure of at least 200 kPa (2.0 bar, 29 psi), press **OFF** on electric air pump switch ④. The electric air pump is switched off.
- ▶ Turn the key in the starter switch to position **0**.
- ▶ Unscrew the end of filler hose ④ from tire valve ⑦.
- ▶ Place the tire repair kit securely in the vehicle.
- ▶ Drive off immediately. The tire sealant will distribute itself evenly inside the tire.

#### ⚠ WARNING

Do not exceed vehicle speed of 50 mph (80 km/h). A tire sealant repair is not designed to operate at higher speeds.

The sticker must be attached on the instrument cluster where it will be easily seen by the driver.

Vehicle handling characteristics of a tire sealant repaired tire may change. Adapt your driving accordingly.

- ▶ After driving for about 1.8 miles (3 km) or ten minutes, stop and exit the vehicle taking all of the appropriate safety precautions.
- ▶ Take the tire repair kit from the vehicle.
- ▶ Screw the end of filler hose ④ onto tire valve ⑦.

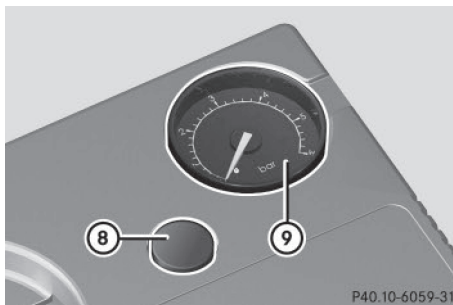

P40.10-6059-31

- ▶ Check the tire inflation pressure using pressure gauge ⑨.

#### ⚠ WARNING

If tire inflation pressure has fallen below 130 kPa (1.3 bar, 19 psi) do not continue to drive the vehicle.

Park your vehicle safely away from the roadway and contact the nearest smart center or call Roadside Assistance.

Have the damaged tire replaced.

- ▶ If the tire inflation pressure is at least 130 kPa (1.3 bar, 19 psi), inflate or deflate the tire to correct tire inflation pressure (see Tire and Loading Information

placard located on the driver's door B-pillar).

- To increase the tire inflation pressure: Switch on the electric air pump.
  - To decrease the tire inflation pressure: Press deflate button (8). Recheck the tire inflation pressure with the electric air pump's pressure gauge (9).
- ▶ When the tire inflation pressure is correct, unscrew the end of filler hose (4) from tire valve (7).
- ▶ Screw the valve cap onto the tire valve.

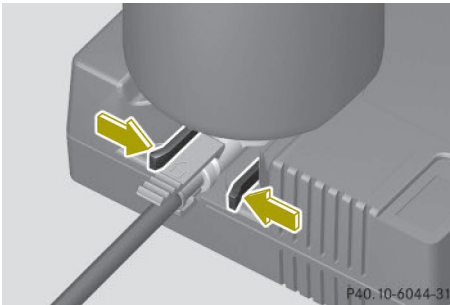

- ▶ To detach tire sealant container (1) from the electric air pump, press both latches.
- ▶ Pull tire sealant container (1) out of fixture (2). Filler hose (4) remains on tire sealant container (1).
- ▶ Place the tire repair kit securely in the vehicle.

**!** The manufacturer is unable to guarantee that all tire punctures can be repaired with the tire repair kit, in particular cuts or perforations larger than approximately 0.16 in (4 mm) or away from the tire's tread. The manufacturer is not liable for damage sustained through improper use of the tire repair kit.

**⚠ WARNING**

Follow recommended tire inflation pressures.

Do not underinflate tires. Underinflated tires wear excessively and/or unevenly, adversely affect handling and fuel economy, and are more likely to fail from being overheated.

Do not overinflate tires. Overinflated tires can adversely affect handling and ride comfort, wear unevenly, increase stopping distance, and result in sudden deflation (blowout) because they are more likely to become punctured or damaged by road debris, potholes etc.

Do not overload the tires by exceeding the specified load limit as indicated on the Tire and Loading Information placard on the driver's door B-pillar. Overloading the tires can overheat them, possibly causing a blowout. Overloading the tires can also result in handling or steering problems, or brake failure.

- ▶ Drive to the nearest authorized smart center, to have the damaged tire replaced.
- ▶ Contact an authorized smart center as soon as possible to obtain a new filler hose and a new tire sealant container.
- ▶ Bring used tire sealant materials to an authorized smart center for proper disposal.
- ▶ Replace your tire sealant container every 4 years. Replacement containers are available at any authorized smart center.

**⚠ WARNING**

After changing a tire, contact a smart center to make sure the bolts holding the wheel to the car are tight enough. Otherwise, the wheels could come off. Each bolt should be tightened to a torque of 81 lb-ft (110 Nm).

## Wheel change

### Preparing the vehicle

- ▶ Park the vehicle on a hard, flat surface when possible.
- ▶ Turn on the hazard warning flasher.
- ▶ Turn the steering wheel so that the front wheels are in a straight-ahead position.
- ▶ Engage the parking brake.
- ▶ Move the gear selector lever to park position **P**.
- ▶ Turn off the engine.
- ▶ Have any passenger exit the vehicle at a safe distance from the roadway.

### Removing the wheel

#### **WARNING**

When jacking up the vehicle, only use a suitable jack. Observe the manufacturer's safety instructions.

The jack must be designed for jacking up this vehicle at the jack take-up brackets built into both sides of the vehicle.

The jack is intended only for lifting the vehicle briefly for wheel changes. It is not suited for performing maintenance work under the vehicle. To help avoid personal injury, use the jack only to lift the vehicle during a wheel change.

Never get beneath the vehicle while it is supported by the jack. Keep hands and feet away from the area under the lifted vehicle. Always lower the vehicle onto sufficient capacity jackstands before working under the vehicle.

Always firmly engage the parking brake and block the wheels with wheel chocks or other sizeable objects before raising the vehicle with the jack. Do not release the parking brake while the vehicle is raised.

Make sure the ground on which the vehicle is standing and where you place the jack is

solid, level and not slippery. If necessary, use a large underlay. On slippery surfaces, such as tiled floors, you should use a non-slip underlay, for example a rubber mat.

Do not use wooden blocks or similar objects to support the jack. Otherwise the jack may not be able to achieve its load-bearing capacity if it is not at its full height.

The jack must always be vertical when in use. Always try to use the jack on level surface. If you do not position the jack correctly, the vehicle can fall off the jack and seriously or fatally injure you or others.

Never start the engine when the vehicle is raised.

Also observe the notes on the jack.

- ▶ Make sure to have a suitable jack<sup>18</sup>, wheel wrench<sup>18</sup> and wheel chock<sup>18</sup>.  
Contact an authorized smart center for information on which jack and wheel wrench are required.
- ▶ Prepare the vehicle as described (▷ page 194).
- ▶ Make sure the surface is level.

Prevent the vehicle from rolling away by blocking wheels with wheel chocks or other sizeable objects:

- ▶ Place one wheel chock or other sizeable object in front of and another wheel chock or other sizeable object behind the wheel that is diagonally opposite to the wheel being changed.

<sup>18</sup> Not included and not available as factory equipment.

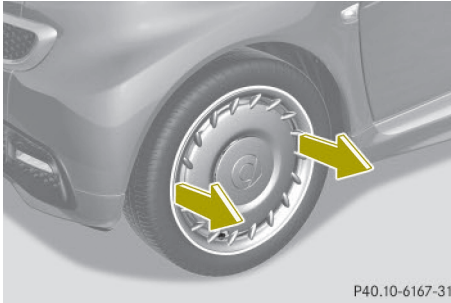

P40.10-6167-31

Steel rim with wheel cover

- ▶ **Vehicles with wheel cover on steel rim:** Pull the wheel cover off of the rim. If necessary, use a suitable tool to pry the wheel cover off.
- ▶ On wheel to be changed, loosen but do not yet remove the wheel bolts (approximately one full turn with wheel wrench).

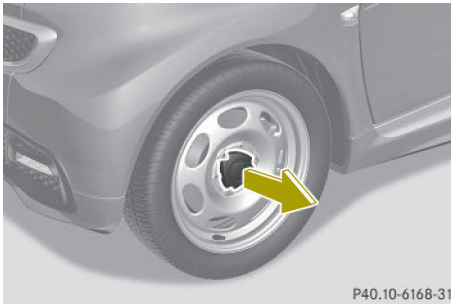

P40.10-6168-31

Steel rim with wheel trim cap

- ▶ **Vehicles with wheel trim cap on steel rim:** On wheel to be changed, loosen but do not yet remove the wheel bolts (approximately one full turn with wheel wrench).
- ▶ Take the wheel trim cap off.

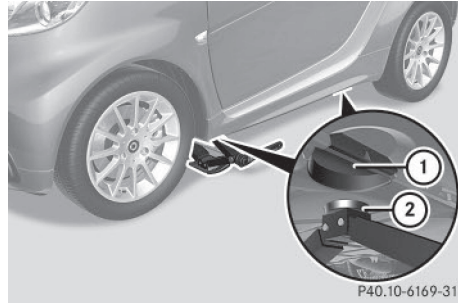

P40.10-6169-31

- ▶ Position jack (2) under take-up bracket (1) so that it is always vertical as seen from the side, even if the vehicle is parked on an incline. The take-up brackets are identified by the embossed recesses in the area of the door sills.

❗ Only position the jack on the designated take-up brackets. Otherwise, the vehicle could be damaged.

- ▶ Jack up the vehicle until the wheel is a maximum of 1.2 in (3 cm) from the ground.
- ▶ Unscrew and remove the wheel bolts.

❗ Do not place wheel bolts in sand or dirt. This could result in damage to the wheel bolts and wheel hub threads.

- ▶ Remove the wheel.

### Mounting the wheel

**⚠ WARNING**

Always replace wheel bolts that are damaged or rusted.

Never apply oil or grease to wheel bolts. Damaged wheel hub threads should be repaired immediately. Do not continue to drive under these circumstances! Contact an authorized smart center or call Roadside Assistance.

Incorrect wheel bolts or improperly tightened wheel bolts can cause the wheel to

»» Practical hints.

come off. This could cause an accident. Be sure to use the correct wheel bolts.

#### WARNING

Only use genuine smart wheel bolts. Other wheel bolts may come loose.

Do not tighten the wheel bolts when the vehicle is raised. Otherwise the vehicle could fall off the jack.

- ▶ Clean contact surfaces of wheel and wheel hub.

- ! To avoid paint damage, place wheel flat against hub and hold it there while installing first wheel bolt.

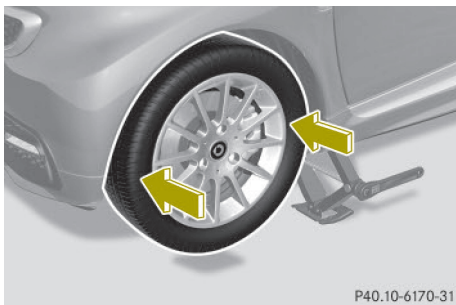

- ▶ Guide the wheel onto the wheel hub and push it on.
- ▶ Insert two wheel bolts and tighten them slightly.
- ▶ **Vehicles with wheel trim cap on steel rim:** Attach the wheel trim cap so that it is held by the two wheel bolts.
- ▶ Install last wheel bolt and tighten it slightly.
- ▶ Lower the vehicle until the vehicle is resting fully on its own weight.
- ▶ Remove the jack.
- ▶ Tighten the wheel bolts. Observe a tightening torque of 80 lb-ft (110 Nm).

#### WARNING

Have the tightening torque checked after changing a wheel. The wheels could come

loose if they are not tightened to a torque of 80 lb-ft (110 Nm).

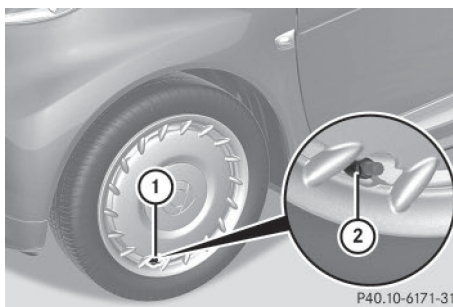

Steel rim with wheel cover

- ▶ **Vehicles with wheel cover on steel rim:** Position wheel cover aperture ① so valve ② fits through.
- ▶ Push the wheel cover evenly onto the wheel rim with both hands.
- ▶ Check that the wheel cover is fixed securely to the wheel rim.

- i The Tire Pressure Monitoring System (TPMS)\* only functions on wheels that are equipped with the proper electronic sensors (> page 127).

## Battery

### About the battery

Your vehicle's battery is located in the passenger footwell below the footrest (> page 198).

The battery should always be sufficiently charged in order to achieve its rated service life. Refer to the Scheduled Maintenance Guide (USA only) or the Service booklet (Canada only) for battery maintenance intervals.

If you use your vehicle mostly for short-distance trips, you will need to have the battery charge checked more frequently.

When replacing the battery, always use batteries approved by smart.

Battery: 12 V and 42 Ah

\* optional

If you do not intend to operate your vehicle for an extended period of time, consult an authorized smart center about steps you need to observe.

 **WARNING**

Observe all safety instructions and precautions when handling automotive batteries.



Risk of explosion.



Fire, open flames and smoking are prohibited when handling batteries. Avoid creating sparks.



Battery acid is caustic. Do not allow it to come into contact with skin, eyes or clothing.

Wear suitable protective clothing, especially gloves, apron and face-guard.



Wear eye protection.

Rinse any acid spills immediately with clear water. Contact a physician if necessary.



Keep children away.



Follow the instructions in this Operator's Manual.

Batteries contain materials that can harm the environment if disposed of improperly. Recycling of batteries is the preferred method of disposal. Many states require sellers of batteries to accept old batteries for recycling.

 **WARNING**

Failure to follow these instructions can result in severe injury or death.

Observe all safety instructions and precautions when handling automotive batteries.

Never lean over batteries while connecting, you might get injured.

Battery fluid contains sulfuric acid. Do not allow this fluid to come in contact with eyes, skin or clothing. In case it does, immediately flush affected area with water and seek medical help if necessary.

A battery will also produce hydrogen gas, which is flammable and explosive. Keep flames or sparks away from battery, avoid improper connection of jumper cables, smoking, etc.

 **WARNING**

Do not place any metal objects on a battery. You could otherwise cause a short circuit and the battery's highly flammable chemicals could ignite.

Never allow any metal object to contact both battery terminals or the positive terminal and the vehicle body at the same time. This might short circuit the battery and ignite the highly flammable and explosive hydrogen gas generated by the battery, causing serious personal injury.

 **WARNING**

Keep flames or sparks away from battery, avoid improper connection of jumper cables, smoking, etc.

- When disconnecting the battery, always disconnect the negative terminal first, followed by positive terminal.
- When connecting the battery, always connect the positive terminal first, followed by the negative terminal.
- Do not loosen or disconnect the battery terminal clips while the engine is running or the key is in the starter switch.

❗ Never loosen or detach battery terminal clamps while the engine is running or the key is in the starter switch. Otherwise the alternator and other electronic components could be severely damaged.

Have the battery checked regularly at an authorized smart center.

Refer to Maintenance Booklet for maintenance intervals or contact an authorized smart center for further information.

❗ Never invert the terminal connections!

**Disconnecting, removing, charging, reinstalling and reconnecting the battery**

### Disconnecting the battery

**i** If the battery is disconnected or discharged

- the key will not turn in the starter switch
- the automatic transmission will remain in park position **P**

For more information see "Jump starting" (> page 199).

- ▶ Engage the parking brake.
- ▶ Move the gear selector lever to park position **P**.
- ▶ Turn off all electrical accessories.
- ▶ Turn off the engine.
- ▶ Open the passenger door.
- ▶ Move the passenger seat to the rear as far as possible.
- ▶ Unscrew the carpet holder in the passenger footwell (> page 158).
- ▶ Lift the carpet.

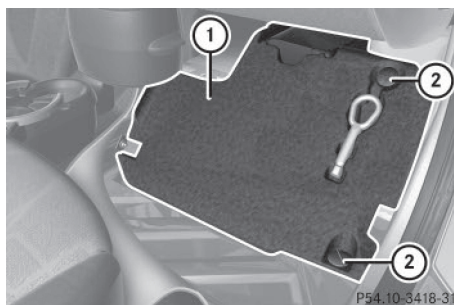

- ▶ Unscrew fastening screw (2) counter-clockwise.
- ▶ Pull footrest (1) sideways out of the vehicle.
- ▶ Read and observe safety instructions and precautions (> page 196).

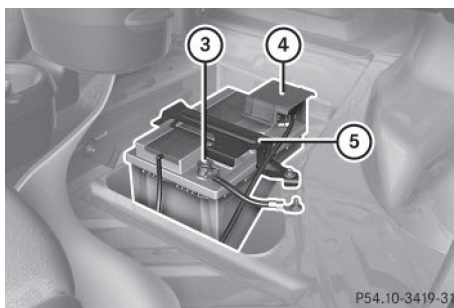

- ❗ Always disconnect the battery in the order described below. Otherwise the vehicle's electronics can be damaged.
- ▶ Disconnect the battery negative lead from negative terminal (3).  
Make sure the negative lead does not come into contact with the positive lead.
- ▶ Remove cover (4) from the positive terminal.
- ▶ Disconnect the battery positive lead.

### Removing the battery

- ▶ Unscrew battery mount (5).
- ▶ Remove the battery support and bracket.
- ▶ Pull out the ventilation hose from the battery (depending on battery arrange-



ment in your vehicle model, the ventilation hose is located either on the left or right side of the battery).

- ▶ Remove the battery.

### Charging the battery

#### WARNING

Avoid creating sparks when charging the battery as escaping gases are flammable. Keep open flames away from the battery and do not smoke.

Do not touch the battery terminal with metal objects and do not remove the battery charger's terminal clamps until the battery charger has been switched off and no further gas is being discharged by the batteries.

Only charge the battery in a well ventilated area.

There is a risk of acid burns during the charging procedure due to the gases which escape from the battery. Do not lean over the battery when it is being charged.

#### WARNING

Never charge a battery while still installed in the vehicle. Gases may escape during charging and cause explosions that may result in paint damage, corrosion or personal injury.

- ▶ Charge battery in accordance with the instructions of the battery charger manufacturer.

**!** Only use chargers of a correct and suitable voltage.

**!** Never attempt to recharge a frozen battery. Have the battery checked at a smart center. The battery housing could be damaged.

### Reinstalling the battery

- ▶ Reinstall the charged battery. Follow the previously described steps in reverse order.

**!** The battery, its filler caps and the ventilation hose must always be securely installed when the vehicle is in operation.

### Reconnecting the battery

**!** Always connect the battery in the order described below. Otherwise the vehicle's electronics can be damaged.

- ▶ Turn off all electrical accessories.
- ▶ Remove the key from the starter switch.

**!** Never invert the terminal connections!

- ▶ Connect the battery positive lead and fasten cover ④ (▷ page 198).
- ▶ Connect battery negative lead ③ (▷ page 198).

**i** After battery power (e.g. due to reconnection) was interrupted, you will have to set the clock (▷ page 88).

**i** Have the battery's charge status and acid level checked at the start of the cold season at a smart center.

>> Practical hints.

### Jump starting

#### Notes

#### WARNING

Failure to follow these directions will cause damage to the electronic components, and can lead to a battery explosion and severe injury or death.

Never lean over batteries while connecting or jump starting, you might get injured.

Battery fluid contains sulfuric acid. Do not allow this fluid to come in contact with eyes, skin or clothing. In case it does,

immediately flush affected area with water, and seek medical help if necessary.

A battery will also produce hydrogen gas, which is flammable and very explosive. Keep flames or sparks away from battery, avoid improper connection of jumper cables, smoking, etc.

Attempting to jump start a frozen battery can result in it exploding, causing personal injury.

Read all instructions before proceeding.

### >> Practical hints.

**!** Do not tow-start vehicle. You could otherwise seriously damage the transmission which is not covered by the smart Limited Warranty.

**!** Avoid repeated and lengthy starting attempts.

Do not attempt to start the engine using a battery quick charge unit.

If the engine does not run after several unsuccessful starting attempts, have it checked at the nearest authorized smart center.

Excessive unburned fuel generated by repeated failed starting attempts may damage the catalytic converter and may present a fire risk.

Make sure the jumper cables do not have loose or missing insulation.

Make sure the cable clamps do not touch any other metal part while the other end is still attached to a battery.

If the battery is discharged, the engine can be started with jumper cables and the fully charged battery of another vehicle or an equivalent starter pack. Observe the following:

- Access to the battery is not possible on all vehicles. If you cannot access the battery in your vehicle provide jump

start power by an external battery or starter pack.

- Jump starting should only be performed when the engine and catalytic converter are cold.
- Do not start the engine if the battery is frozen. Let the battery thaw out first.
- Only jump start from batteries with the same voltage rating (12 V). Jump starting with a more powerful battery could damage the vehicle's electrical system. Such damage will not be covered by the smart Limited Warranty.
- Only use jumper cables with sufficient cross-section and insulated terminal clamps.
- Always make sure the jumper cables are not on or near pulleys, fans or other parts that move when an engine is started or running.
- Should the battery be drained completely, let the donating power source charge the vehicle for several minutes before reattempting the starting process.

#### **WARNING**

Keep flames or sparks away from battery. Do not smoke.

Observe all safety instructions and precautions when handling automotive batteries.

### Jump start assistance

Your vehicle's battery is located in the passenger footwell below the footrest (▷ page 198).

For jump starting, use the terminals of the battery, keeping the leads connected.

- ▶ Make sure the two vehicles do not touch.
- ▶ Switch off all electrical consumers.
- ▶ Engage the parking brake.
- ▶ Move the gear selector lever to park position **P**.
- ▶ Turn off the engine.
- ▶ Get access to the battery in the passenger footwell (▷ page 198).
- ▶ Remove the positive terminal cover.

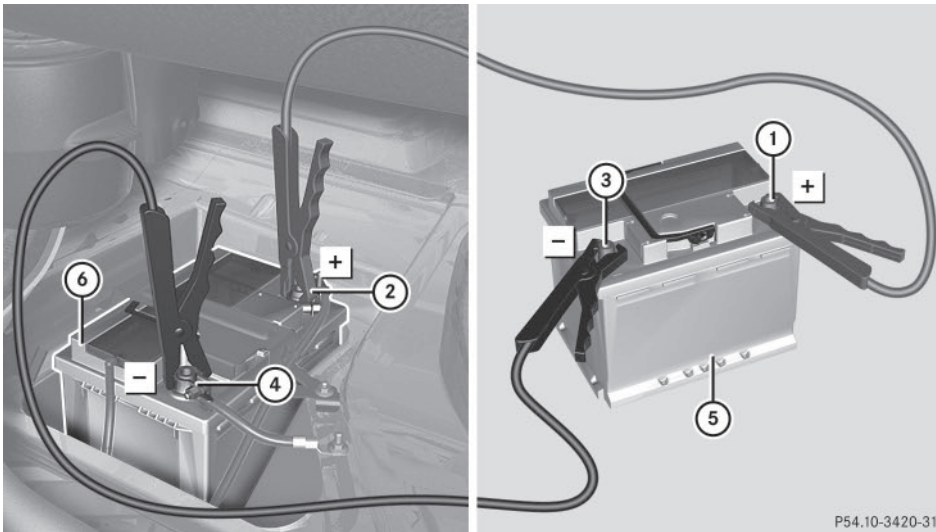

Position ⑤ represents the charged battery of another vehicle or an equivalent starter pack.

**!** Never invert the terminal connections!

- ▶ Connect positive terminal ① of charged battery ⑤ with positive terminal ② of discharged battery ⑥ with a jumper cable. Clamp the jumper cable to positive terminal ① of charged battery ⑤ first.
- ▶ Start the engine of the vehicle with charged battery ⑤ and run at idle speed.
- ▶ Connect negative terminal ③ of charged battery ⑤ with negative terminal ④ of discharged battery ⑥ with a jumper cable. Clamp the jumper cable to negative terminal ③ of charged battery ⑤ first.
- ▶ Start the engine of the vehicle with discharged battery ⑥ and run at idle speed. You can now switch on the electrical consumers. Do not switch on the headlamps under any circumstances.

>> Practical hints.

P54.10-3420-31

- ▶ Remove the jumper cables from negative terminals ③ and ④ first.
- ▶ Remove the jumper cables from positive terminals ① and ②.  
You can now switch on the headlamps.
- ▶ Remount the positive terminal cover.
- ▶ Have the battery checked at the nearest authorized smart center.

## Towing

### About towing

This section offers information on towing methods for breakdown situations, emergency towing, and flat towing smart vehicles.

### Recommended towing method - Breakdown situation

**!** To prevent damage during transport, do not tie down the vehicle by its chassis or suspension parts – use only wheel straps to position and hold down the vehicle.

Improper tie down on a flatbed carrier truck or trailer can damage suspension parts and body panels.

smart recommends that the vehicle be transported with all wheels off the ground using a flatbed carrier truck or appropriate wheel lift/dolly equipment.

- ▶ Switch off the tow-away protection\* and interior motion sensor\* (> page 49).

### Emergency towing

When circumstances do not permit the recommended towing method, the vehicle may be towed with all wheels on the ground using a strap or tow bar connected to another vehicle. Only tow the vehicle as far as necessary to have the vehicle moved to a safe location where the recommended towing method can be employed.

### WARNING

If circumstances require towing the vehicle with all wheels on the ground, always tow with a tow bar if:

- the engine will not run
- there is a malfunction in the brake system
- there is a malfunction in the power supply or in the vehicle's electrical system

A tow bar is necessary to adequately control the towed vehicle.

Prior to towing the vehicle with all wheels on the ground, make sure the gear selector lever is in neutral position **N** and the ignition is switched off.

### WARNING

With the engine not running, there is no power assistance for the brake and steering\* systems. In this case, it is important to keep in mind that a considerably higher degree of effort is necessary to brake and steer the vehicle. Adapt your driving accordingly.

**!** Do not tow the vehicle with the front axle raised. Doing so may cause serious damage to the brake system which is not covered by the smart Limited Warranty.

**!** Before towing the vehicle observe the following instructions:

- Do not tow with sling-type equipment attached to suspension parts. This may cause damage to the radiator and other supports if towing on a bumpy road.
- Towing the vehicle should only be done using the properly installed towing

\* optional

eye bolt. Never attach a tow cable, tow rope, or tow rod to the vehicle chassis, frame, or suspension parts.

**!** Make sure the ignition is switched off while towing the vehicle. Doing otherwise may result in

- the ESP® being activated. Active braking action through the ESP® may seriously damage the brake system which is not covered by the smart Limited Warranty.
- a discharged battery.

**!** Make sure the gear selector lever is in neutral position **N** while towing the vehicle. Doing otherwise may result in significant drive train damage.

**!** Towing the vehicle with a luggage rack\* mounted is not permissible. The vehicle must not be towed by the luggage rack\*.

**i** If the battery is disconnected or discharged, the gear selector lever will remain locked in park position **P**. Contact an authorized smart center for assistance or call Roadside Assistance.

### Towing eye bolt

The towing eye bolt is located in the passenger footwell under the carpet.

- ▶ Unscrew the carpet holder in the passenger footwell (> page 158).
- ▶ Lift the carpet.

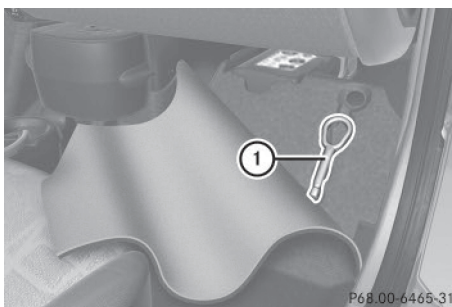

- ▶ Take out towing eye bolt ①.

\* optional

### Installing towing eye bolt

Depending of whether you are towing a vehicle or being towed, the towing eye bolt can be screwed into threaded holes which are located behind covers on the front and rear bumper.



Front cover

#### **!** WARNING

High outside temperature, stop-and-go traffic, driving on long uphill grades, or driving at high engine speed may increase the temperature in the engine compartment. Therefore the area around the air slots in the rear apron may be hot. Let the engine cool off before touching this area to prevent burns.

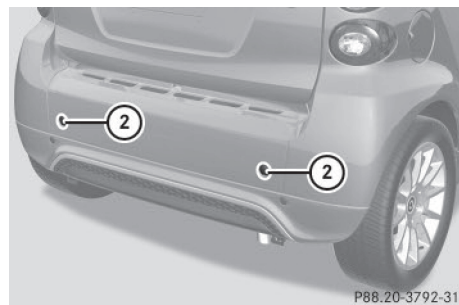

Rear covers

- ▶ Remove respective cover ① or ② using a suitable object to reveal the threaded hole for the towing eye bolt.
- ▶ Screw towing eye bolt in clockwise to its stop and tighten with a suitable object.

>> Practical hints.

### **WARNING**

For safety reasons, recovery or lashing down of the vehicle by means of the towing eye is not allowed. Failure to observe this could result in the towing eye being ripped out of its mounting and people being injured.

### Towing the vehicle

- ▶ Engage the parking brake.
- ▶ Connect the strap or tow bar to the towing eye.
- ▶ Switch on the ignition.
- ▶ Depress the brake pedal and keep it pressed.
- ▶ Move the gear selector lever to neutral position **N**.
- ▶ Release the brake pedal.
- ▶ **i** With the gear selector lever in neutral position **N**, the key cannot be turned fully to starter switch position **0**. Therefore turn the key in the starter switch as far left as it will go when switching off the ignition.
- ▶ Switch off the ignition.
- ▶ Leave the key in the starter switch.
- ▶ Switch on the hazard warning flasher.
- ▶ Release the parking brake.

### Flat towing

Flat towing is when all wheels of the vehicle are on the ground during the tow.

For vehicles that will be flat towed over long distances observe the following recommendations:

- ▶ **Preparing the vehicle:** Contact an authorized smart center for information on recommended tow bar equipment and installing a matching on/off switch on the battery terminal.
- ▶ **Before towing:** Make sure the ignition is switched on.

- ▶ Engage the parking brake.
- ▶ Depress the brake pedal and keep it pressed.
- ▶ Move the gear selector lever to neutral position **N**.
- ▶ Release the brake pedal.
- ▶ **i** With the gear selector lever in neutral position **N**, the key cannot be turned fully to starter switch position **0**. Therefore turn the key in the starter switch as far left as it will go when switching off the ignition.
- ▶ Switch off the ignition.
- ▶ Leave the key in the starter switch.
- ▶ Wait approximately 30 seconds until the multifunction display in the instrument cluster is completely blank.
- ▶ Turn the battery off using the previously installed battery switch.
- ▶ Release the parking brake.
- ▶ **During towing:** Make sure the gear selector lever remains in neutral position **N** with the ignition switched off.
- ▶ **After towing:** Engage the parking brake.
- ▶ Turn the battery on using the previously installed battery switch.
- ▶ Move the gear selector lever to park position **P**.
- ▶ Remove the key from the starter switch.
- ▶ Lock the doors.

⚠ Do not flat tow the vehicle with the front axle raised. Doing so may cause serious damage to the brake system which is not covered by the smart Limited Warranty.

⚠ Failure to follow the recommendations for flat towing can cause damage to your vehicle:

- Not following the battery disconnect procedure in the proper sequence may

result in data loss in the vehicle's control units.

- Not disconnecting the battery and leaving the key in starter switch position **1** (ignition on) may result in
  - the vehicle locking. The vehicle will lock if the wheels are turning at vehicle speeds of approximately 8 mph (14 km/h) or more.
  - the ESP® being activated. Active braking action through the ESP® may seriously damage the brake system which is not covered by the smart Limited Warranty.
- Not moving the gear selector lever to neutral position **N** may result in significant transmission damage.
- in a discharged battery.

## Fuses

The electrical fuses in your vehicle serve to switch off malfunctioning power circuits.

If a fuse is blown, the components and systems secured by that fuse will stop operating.

### WARNING

Only use fuses approved by smart with the specified amperage for the system in question and do not attempt to repair or bridge a blown fuse this may cause an overload leading to a fire, and/or cause damage to electrical components and/or systems. Contact a smart center if you encounter any electrical problems.

- ❗ A blown fuse must be replaced by an appropriate spare fuse (recognizable by its color or the fuse rating given on the fuse) of the amperage recommended in the fuse chart. Any smart center will be glad to advise you on this subject.

If a newly inserted fuse blows again, have the cause determined and rectified at an authorized smart center.

Before replacing fuses:

- Engage the parking brake.
- Make sure the gear selector lever is in park position **P**.
- Turn off all electrical accessories.
- Turn off the engine.
- Remove the key from the starter switch.

## Replacing a fuse

The fuse box is located on the driver's side below the dashboard.

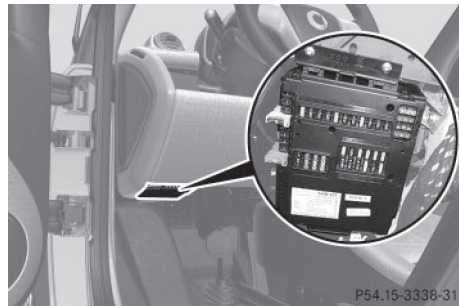

- ▶ From the fuse chart (▷ page 207), determine which fuse belongs to the malfunctioning accessory or component.
- ▶ Remove the respective fuse.
- ▶ Replace the defective fuse with a new one of the same amperage.

>> Practical hints.

## Fuse box

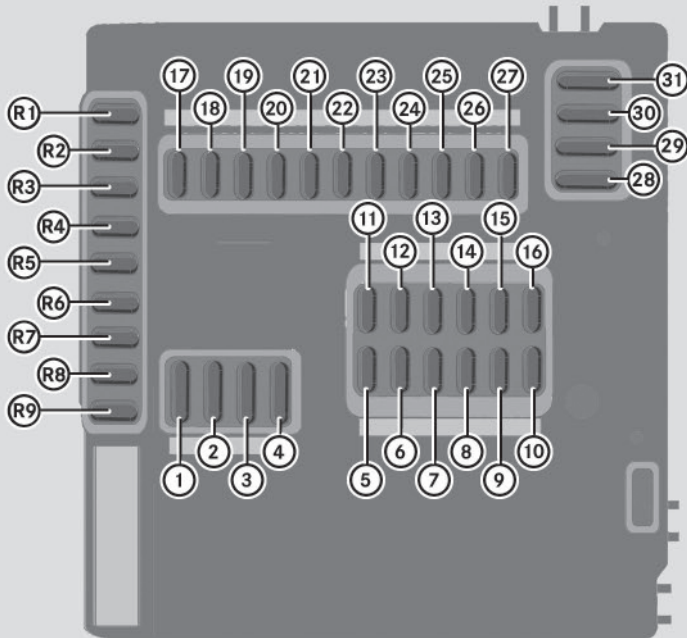

P54.15-3349-31

Front side

① - ⑩ Fuse

Ⓡ① - Ⓡ⑨ Backup fuse slots

&gt;&gt; Practical hints.



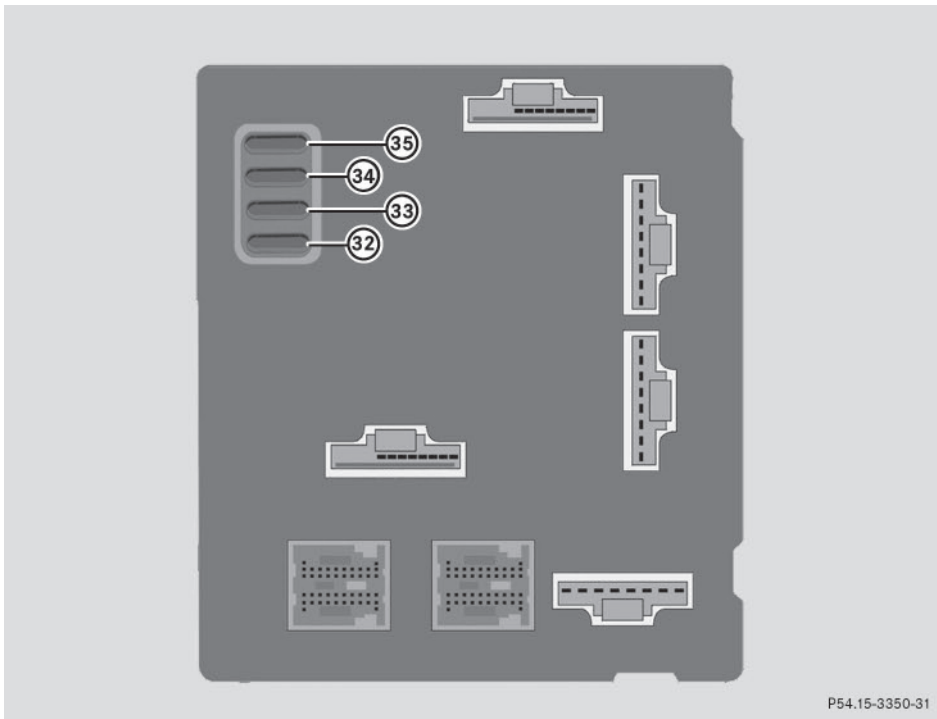

Rear side

③② - ③⑤ Fuse

>> Practical hints.

#### Fuse chart

No.	Accessory/Component	Amperage	Color
①	Engine	25 A	Neutral
②	Windshield wipers	25 A	Neutral
③	Power window (left and right)	20 A	Yellow
④	Passenger compartment blower (HVAC)	25 A	Neutral
⑤	Front fog lamps, LED daytime running lamps	10 A	Red
⑥	Right parking lamp, right tail lamp, license plate lamps	7.5 A	Brown
⑦	Left parking lamp, left tail lamp	7.5 A	Brown
⑧	Engine, tank ventilation	25 A	Neutral
⑨	Engine	7.5 A	Brown

&gt;&gt; Practical hints.

No.	Accessory/Component	Amperage	Color
⑩	Engine, transmission, shifter	15 A	Blue
⑪	ESP® control unit	25 A	Neutral
⑫	Exterior lamp switch, turn signal lamp switch, cockpit switch module, on-board diagnostics socket, transmission control unit, exterior rear view mirror heating, anti-theft warning system, rain-light sensor, auxiliary instruments, central locking system, instrument cluster, Tire Pressure Monitoring System (TPMS), brake and turn signal lamps (left and right)	10 A	Red
⑬	—	—	—
⑭	Air conditioning compressor	15 A	Blue
⑮	Audio, subwoofer, sound system, soft top (cabriolet only), interior light	15 A	Blue
⑯	Fuel pump with fuel level sensor	15 A	Blue
⑰	Rear window wiper (coupé only)	15 A	Blue
⑱	ESP® control unit, EPS control unit, restraint system	10 A	Red
⑲	Engine control unit, transmission control unit, Tire Pressure Monitoring System (TPMS), on-board diagnostics socket	7.5 A	Brown
⑳	Air conditioning system, exterior rear view mirror adjustment, washer pump, audio, seat heating, wiper switch, soft top switch (cabriolet only)	10 A	Red
㉑	Auxiliary power outlet	15 A	Blue
㉒	Left low-beam headlamp	7.5 A	Brown
㉓	Right low-beam headlamp	7.5 A	Brown
㉔	Backup lamp	15 A	Blue
㉕	Right high-beam headlamp	7.5 A	Brown
㉖	Left high-beam headlamp	7.5 A	Brown
㉗	Engine	7.5 A	Brown
㉘	Rear window defroster	40 A	Orange

No.	Accessory/Component	Amperage	Color
②9	Soft top (cabriolet only)	30 A	Green
③0	Transmission control unit, radiator cooling fan	40 A	Orange
③1	Horn, central locking system	20 A	Yellow
③2	—	—	—
③3	Starter switch (ignition)	50 A	Red
③4	ESP® control unit	40 A	Orange
③5	EPS control unit	30 A	Green
Ⓡ1	Exterior rear view mirror heating	7.5 A	Brown
Ⓡ2	Brake lamps	7.5 A	Brown
Ⓡ3	—	—	—
Ⓡ4	—	—	—
Ⓡ5	Windshield unit car2go	10 A	Red
Ⓡ6	—	—	—
Ⓡ7	Interior lighting	5 A	Light brown
Ⓡ8	Surround sound system	20 A	Yellow
Ⓡ9	Seat heating control unit	25 A	Neutral

>> Practical hints.





Parts service .....	212
Warranty coverage .....	212
Engine electronics .....	212
Identification labels .....	213
Vehicle specification (model pure) .....	215
Vehicle specification (model passion) .	215
Vehicle specification (model BRABUS) .	216
Rims and tires .....	216
Service fluids and capacities .....	218

**>> Technical data.**

### Parts service

The "Technical data" section provides the necessary technical data for your vehicle. Genuine smart Parts are subjected to stringent quality inspections. Each part has been specifically developed, manufactured or selected for and adapted to smart vehicles.

Therefore, Genuine smart Parts should be installed.

**!** The use of non-genuine smart parts and accessories not authorized by smart could damage the vehicle, which is not covered by the smart Limited Warranty, or could compromise the vehicle's durability or safety.

### Warranty coverage

Your vehicle is covered under the terms of the warranties printed in the smart USA Warranty booklet (USA only) or the Warranty booklet (Canada only).

Your authorized smart center will exchange or repair any defective parts originally installed on the vehicle in accordance with the terms of the following warranties:

- smart USA Limited Warranty (USA only)
- New Vehicle Limited Warranty (Canada only)
- Emission System Warranty
- Emission Performance Warranty
- Corrosion Warranty
- California, Connecticut, Maine, Massachusetts, New York, Pennsylvania, Rhode Island, and Vermont Emission Control System Warranty
- smartmove Assistance (Canada only)
- State Warranty Enforcement Laws (Lemon Laws, USA only)

Replacement parts and accessories are covered by the smart Parts and Accessories

warranties, copies of which are available at any authorized smart center.

### Loss of Warranty booklet

Should you lose your smart USA Warranty booklet (USA only) or the Warranty booklet (Canada only), have an authorized smart center arrange for a replacement. It will be mailed to you.

## Engine electronics

### Work on engine electronics

#### WARNING

Always have maintenance work on engine electronics and components performed by a qualified specialist, e.g. at a smart center. In particular, work relevant to safety or on safety related systems must be carried out at a qualified specialist workshop.

**!** Always have maintenance work on the engine electronics and components, such as control modules, sensors and connecting cables, performed by a qualified specialist who has the necessary knowledge and tools to carry out the work required, e.g. at a smart center. Otherwise there is a danger that vehicle components may wear more rapidly, which may void the vehicle's warranty.

### Retrofitting electrical and electronic devices

Electrical and electronic devices can endanger vehicle operating safety.

**!** Damage or consequential damage due to retrofitting a device in the vehicle is not covered by smart's warranty.

If you install telephones or radio transmitters in the vehicle you must have such retrofits approved. smart approves the installation of telephones and radio devi-

ces if the work is done professionally and the device is connected to a low-reflection exterior antenna.

The transmitting power of the telephone or radio must not exceed the following maximum values.

Frequency range (band)	Maximum transmitting power (Watts)
Short wave (<50 MHz)	100
2 m wavelength	50
0.7 m wavelength	35
0.25 m wavelength	10

**⚠ WARNING**

Radio transmitters can interfere with the vehicle's electronic system, endanger the operating safety of the vehicle and thus your own safety, if

- there is no external antenna
- the external antenna is not low-reflection
- the external antenna is incorrectly installed

Excessive electromagnetic radiation can damage your health and that of others. Using an external antenna addresses and considers the concerns currently being discussed in scientific circles about the health hazards possibly posed by electromagnetic fields.

Because of this, have the external antenna installed exclusively at a qualified specialist workshop which has the necessary specialist knowledge and tools to carry out the work required, e.g. at a smart center. In particular, work relevant to safety or on safety-related systems must be carried out at a qualified specialist workshop.

**On-board Diagnostics Socket (OBD)**

The on-board diagnostics socket is located inside the vehicle on the right side of the left footwell.

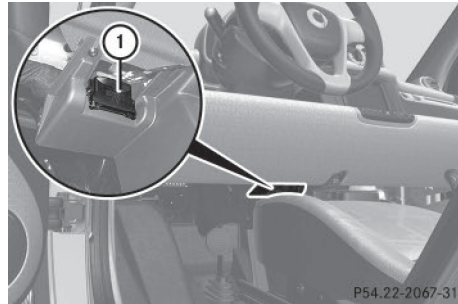

① On-board diagnostics socket

**Identification labels**

**Signs and labels**

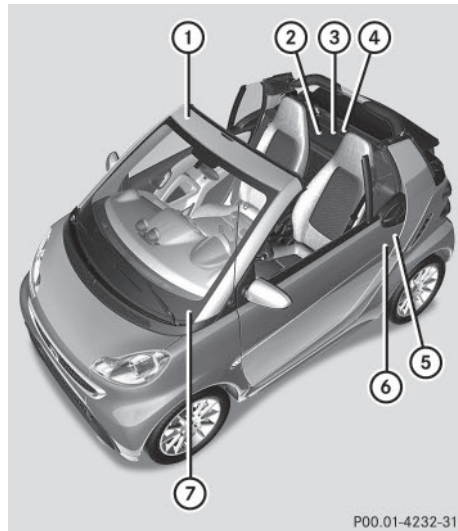

- ① Air bag information signs (sun visor)
- ② VIN (engine compartment)
- ③ Emission control information label, includes both federal and California certification exhaust emission standards (engine compartment)

>> Technical data.

- ④ Heat warning label (engine compartment)
- ⑤ Certification label (driver's door B-pillar)
- ⑥ Tire and loading information placard (driver's door B-pillar)
- ⑦ VIN (lower edge of windshield)

### Certification label

- ▶ Open the driver's door.

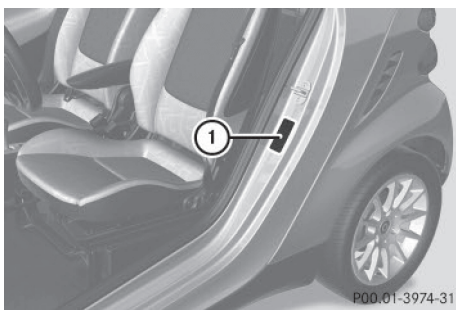

- ① Certification label (on driver's door B-pillar)

**i** Data shown on the example certification label are for illustration purpose only. These data are specific to each vehicle and may vary from data shown in the illustration. Refer to certification label on vehicle for actual data specific to your vehicle.

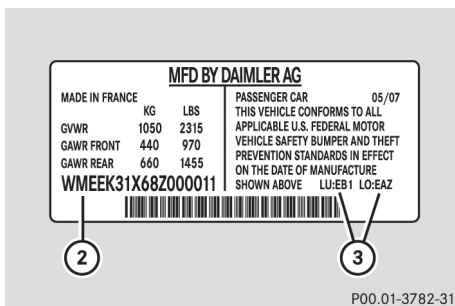

- Example certification label (U.S. vehicles)
- ② Vehicle Identification Number (VIN)
  - ③ Paintwork code

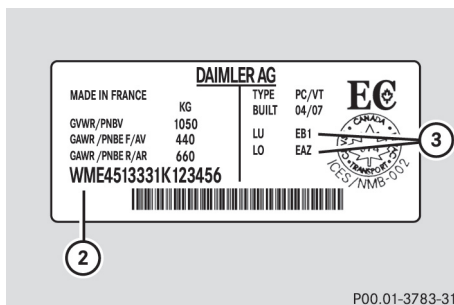

Example certification label (Canada vehicles)

- ② Vehicle Identification Number (VIN)
- ③ Paintwork code

### Vehicle Identification Number (VIN)

The Vehicle Identification Number (VIN) can be found in the following locations:

- on the certification label on the driver's door B-pillar (▷ page 214)
- on the rear right on the cargo compartment floor (▷ page 214)
- in the lower edge of the windshield (▷ page 213)

- ▶ Open the cargo compartment.
- ▶ Fold back the carpet.

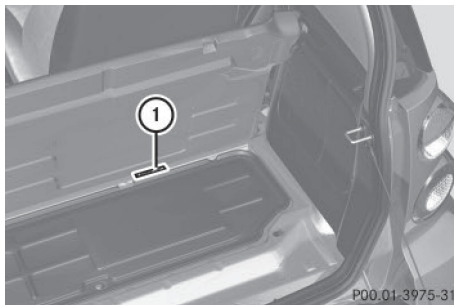

- ① VIN (on the cargo compartment floor)

### Engine number

The engine number is engraved into the engine block. For more information, contact any authorized smart center.



**i** When ordering parts, please specify vehicle identification and engine number.

**Vehicle specification (model pure)**

The quoted data apply only to the standard vehicle. Contact an authorized smart center for the corresponding data of all special bodies and special equipment.

Main dimensions (model pure)	
Overall vehicle length	106.1 in (2695 mm)
Overall vehicle width <sup>19</sup>	69.0 in (1752 mm)
Overall vehicle height	61.2 in (1555 mm)
Wheelbase	73.5 in (1867 mm)
Turning circle	28.7 ft (8.75 m)

Weights (model pure)	
Cargo compartment load	max. 110 lb (50 kg)
Roof load <sup>20</sup>	None

**⚠ WARNING**

No racks or loads may be secured to the roof of the vehicle, as

- the panorama roof\* may be damaged, thus injuring persons
- this can have a substantial adverse effect on the driving dynamics of the vehicle, thus causing accidents
- the rack and/or the load could detach and through this cause an accident or other people could be injured by the load and/or rack that has fallen off

**Vehicle specification (model passion)**

The quoted data apply only to the standard vehicle. Contact an authorized smart center for the corresponding data of all special bodies and special equipment.

Main dimensions (model passion)	
Overall vehicle length	106.1 in (2695 mm)
Overall vehicle width <sup>21</sup>	69.0 in (1752 mm)
Overall vehicle height	61.2 in (1555 mm)
Wheelbase	73.5 in (1867 mm)
Turning circle	28.7 ft (8.75 m)

Weights (model passion)	
Cargo compartment load	max. 110 lb (50 kg)
Roof load <sup>22</sup>	None

>> Technical data.

<sup>19</sup> Exterior rear view mirrors folded out.

<sup>20</sup> This vehicle is not intended to carry items on its roof. Thus roof rails and any roof-mounted devices must not be used.

<sup>21</sup> Exterior rear view mirrors folded out.

<sup>22</sup> This vehicle is not intended to carry items on its roof. Thus roof rails and any roof-mounted devices must not be used.

\* optional

**⚠ WARNING**

No racks or loads may be secured to the roof of the vehicle, as

- the panorama roof\* may be damaged, thus injuring persons
- this can have a substantial adverse effect on the driving dynamics of the vehicle, thus causing accidents
- the rack and/or the load could detach and through this cause an accident or other people could be injured by the load and/or rack that has fallen off

**⚠ WARNING**

No racks or loads may be secured to the roof of the vehicle, as

- the panorama roof\* may be damaged, thus injuring persons
- this can have a substantial adverse effect on the driving dynamics of the vehicle, thus causing accidents
- the rack and/or the load could detach and through this cause an accident or other people could be injured by the load and/or rack that has fallen off

**>> Technical data.****Vehicle specification (model BRABUS)**

The quoted data apply only to the standard vehicle. Contact an authorized smart center for the corresponding data of all special bodies and special equipment.

**Main dimensions (model BRABUS)**

<b>Overall vehicle length</b>	107.4 in (2727 mm)
<b>Overall vehicle width<sup>23</sup></b>	69.0 in (1752 mm)
<b>Overall vehicle height</b>	61.2 in (1555 mm)
<b>Wheelbase</b>	73.5 in (1867 mm)
<b>Turning circle</b>	28.7 ft (8.75 m)

**Weights (model BRABUS)**

<b>Cargo compartment load</b>	max. 110 lb (50 kg)
<b>Roof load<sup>24</sup></b>	None

<sup>23</sup> Exterior rear view mirrors folded out.

<sup>24</sup> This vehicle is not intended to carry items on its roof. Thus roof rails and any roof-mounted devices must not be used.

**Rims and tires****Notes**

**!** Only use tires which have been tested and approved by smart. Tires approved by smart are developed to provide best possible performance in conjunction with the driving safety systems on your vehicle such as the ABS or the ESP®. Using tires other than those approved by smart may result in damage that is not covered by the smart Limited Warranty.

**!** Using tires other than those approved by smart can have detrimental effects, such as

- poor handling characteristics
- increased noise
- increased fuel consumption

Moreover, tires and rims not approved by smart may, under load, exhibit dimensional variations and different tire deformation characteristics that could cause them to come into contact with the vehicle body or axle parts. Damage to the tires or the vehicle may be the result.

**i** Further information on tires and rims is available at any authorized smart cen-

\* optional

ter. A placard with the recommended tire inflation pressure is located on the driver's door B-pillar.

The tire inflation pressure should be checked regularly and should only be adjusted on cold tires. Follow tire manufacturer's maintenance recommendation included with vehicle.

### Mobility

Your vehicle is equipped with a tire repair kit (> page 186). In case of a flat tire, it enables you to drive to the nearest authorized smart center on the sealed tire.

If the tire is damaged too severely for the tire sealant to provide a reliable tire repair:

- ▶ Contact the nearest authorized smart center.

or

- ▶ Call Roadside Assistance.

## Mixed size tires

**i** In the following tables, the models are represented by codes:



- V1: model pure
- V2: model passion
- V3: model BRABUS

Abbreviations used in the following tables:

- FA: Front Axle
- RA: Rear Axle

>> Technical data.

	All-season tires	Light alloy rims	V1	V2	V3
FA	155/60 R 15 74T M+S	4.5 J x 15 H2 <sup>25</sup> Wheel offset: 0.93 in (23.5 mm)	•	•	—
RA	175/55 R 15 77T M+S	5.5 J x 15 H2 <sup>25</sup> Wheel offset: 0.87 in (22 mm)			
FA	165/60 R 15 77T M+S	5.0 J x 15 H2 Wheel offset: 1.34 in (34 mm)	•	•	—
RA	195/50 R 15 82T M+S	6.5 J x 15 H2 Wheel offset: 1.36 in (34.5 mm)			
FA	175/55 R 15 77T M+S	5.5 J x 15 H2 Wheel offset: 1.18 in (30 mm)	—	—	•
RA	215/35 R 17 79H M+S	7.5 J x 17 H2 Wheel offset: 1.30 in (33 mm)			

	Winter tires <sup>26</sup>	Light alloy rims	V1	V2	V3
FA	155/60 R 15 74T M+S 	4.5 J x 15 H2 Wheel offset: 0.93 in (23.5 mm)	•	•	•
RA	175/55 R 15 77T M+S 	5.5 J x 15 H2 Wheel offset: 0.87 in (22 mm)			

## Service fluids and capacities

## Notes

Vehicle components and their respective lubricants must match. Therefore only use products tested and approved by smart.

Please contact an authorized smart center for products tested and approved by smart.

 **WARNING**

Comply with all valid regulations with respect to handling, storing and disposing

<sup>25</sup> Model pure only: Available as steel rim or light alloy rim\*.

<sup>26</sup> Not available as factory equipment.

of service fluids. Otherwise you could endanger persons or the environment. Keep service fluids out of the reach of children.

For health reasons, you should prevent service fluids from coming into direct contact with your skin or clothing.

If a service fluid is swallowed, contact a physician immediately.



>> **Technical data.**

### Capacities

Components	Model	Capacity	Fuels, coolants, lubricants, etc.
Engine with oil filter	All models	3.6 US qt (3.4 l)	Approved engine oils
Cooling system	All models	approx. 4.5 US qt (4.3 l)	Anticorrosion/Antifreeze meeting specification MB 325.0
Fuel tank	All models	8.72 US gal (33.0 l)	Premium unleaded gasoline (Minimum Posted Octane 91 [Avg. of 96 RON/86 MON])
Fuel tank reserve	All models	approx. 1.32 US gal (5.0 l)	
Air conditioning system*	All models	—	R134a refrigerant and special PAG lubricant oil (never R 12)
Windshield washer system	All models	4.0 US qt (3.8 l)	Windshield washer concentrate <sup>27</sup> (> page 222) Washer fluid mixing ratio (> page 222)

>> Technical data.

### Engine oils

Engine oils are specifically tested for their suitability in our engines and durability for our service intervals. Therefore, only use engine oils and oil filters required for vehicles with the Maintenance System. For a listing of approved engine oils and oil filters contact an authorized smart center.

**!** Using engine oils and oil filters of specification other than those expressly required for the Maintenance System, or changing of oil and oil filter at change intervals longer than those called for by the Maintenance System will result in engine or emission control system damage not covered by the smart Limited Warranty.

Please follow Maintenance System recommendations for scheduled oil changes. Failure to do so will result in engine or emission control system damage not covered by the smart Limited Warranty.

### Viscosity grades for engine oils

Using the chart below, select oil viscosity according to the lowest air temperature expected before the next oil change.

<sup>27</sup> Use a windshield washer concentrate labeled for summer and water for temperatures above freezing point or a windshield washer concentrate labeled for winter and water for temperatures below freezing point.

\* optional

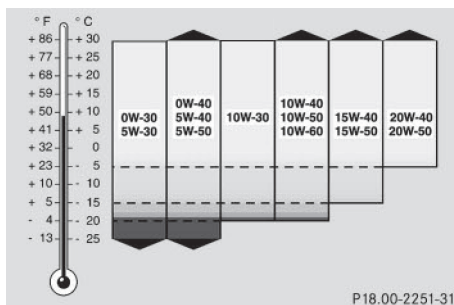

### Engine oil additives

- ❗ Do not blend oil additives with engine oil. They may damage the engine. Damage or malfunctions resulting from blending oil additives are not covered by the smart Limited Warranty. Any authorized smart center will provide you with additional information.

### Air conditioning refrigerant

R134a (HFC) refrigerant and special PAG lubricating oil are used in the air conditioning system.

- ❗ Never use R 12 (CFC) or mineral-based lubricating oil. Otherwise damage to the system will occur.

### Brake fluid

#### ⚠ WARNING

During vehicle operation, the boiling point of the brake fluid is continuously reduced through the absorption of moisture from the atmosphere. Under extremely strenuous operating conditions, this moisture content can lead to the formation of bubbles in the system, thus reducing the system's efficiency.

Therefore, the brake fluid must be replaced regularly. Refer to your vehicle's Maintenance Booklet for replacement interval.

Only brake fluid approved by smart is recommended. Any authorized smart center will provide you with additional information.

### Premium unleaded gasoline

#### ⚠ WARNING

Gasoline is highly flammable and poisonous. It burns violently and can cause serious personal injury.

Never allow sparks, flame or smoking materials near gasoline!

Turn off the engine before refueling.

Whenever you are around gasoline, avoid inhaling fumes and skin or clothing contact. Extinguish all smoking materials.

Direct skin contact with fuels and the inhalation of fuel vapors are damaging to your health.

- ❗ To maintain the engine's durability and performance, premium unleaded gasoline must be used. If premium unleaded gasoline is not available and low octane fuel is used, follow these precautions:

- Have the fuel tank only partially filled with unleaded regular gasoline and fill up with premium unleaded gasoline as soon as possible.
- Avoid full throttle driving and abrupt acceleration.
- Do not exceed an engine speed of 3000 rpm if the vehicle is loaded with a light load such as two persons and no cargo.
- Do not exceed  $\frac{2}{3}$  of maximum accelerator pedal position if the vehicle is fully loaded or operating in mountainous terrain.

### Fuel requirements

Only use premium unleaded fuel. The octane number (posted at the pump) must be 91 min.

It is an average of both the **Research Octane Number (RON)** and the **Motor Octane Number (MON)**:  $(RON+MON)/2$ . This is also known as the **ANTI-KNOCK INDEX**.

Unleaded gasoline containing oxygenates such as ethanol, IPA, IBA and TBA can be used provided the ratio of any one of these oxygenates to gasoline does not exceed 10%; MTBE must not exceed 15%.

The ratio of methanol to gasoline must not exceed 3% plus additional cosolvents.

Using mixtures of ethanol and methanol is not allowed. Gasohol, which contains 10% ethanol and 90% unleaded gasoline, can be used.

These blends must also meet all other fuel requirements, such as resistance to spark knock, boiling range, vapor pressure, etc.

#### Gasoline additives

A major concern among engine manufacturers is carbon build-up caused by gasoline. smart recommends only the use of quality gasoline containing additives that prevent the build-up of carbon deposits.

After an extended period of using fuels without such additives carbon deposits can build up, especially on the intake valves and in the combustion area, leading to engine performance problems such as:

- Warm-up hesitation
- Unstable idle
- Knocking/pinging
- Misfire
- Power loss

In areas where carbon deposits may be encountered due to lack of availability of gasolines which contain these additives, the use of smart approved additives is recommended. Contact an authorized smart center for a listing of approved products. Follow directions on the product label.

Do not blend other fuel additives with fuel. This only results in unnecessary costs and may be harmful to the engine operation.

**!** Damage or malfunction resulting from poor fuel quality or from blending additional fuel additives other than those tested and approved by us for use on smart vehicles are not covered by the smart Limited Warranty.

#### Windshield/rear window washer system

During all seasons:

- ▶ Use a windshield washer concentrate labeled for summer and water for temperatures above freezing point.
- ▶ Use a windshield washer concentrate labeled for winter and water for temperatures below freezing point.
- ▶ Premix the windshield washer fluid in a suitable container depending on the outside temperature and in accordance with the manufacturer's instructions<sup>28</sup>.

#### Washer fluid mixing ratio

- Temperature above 32°F (0°C):  
1 part windshield washer concentrate labeled for summer to 100 parts water
- Temperature of 14°F (-10°C):  
1 part windshield washer concentrate labeled for winter to 2 parts water
- Temperature of -4°F (-20°C):  
1 part windshield washer concentrate labeled for winter to 1 part water

#### **!** WARNING

Windshield washer concentrate is highly flammable. Fire, naked flames and smoking are prohibited when windshield washer concentrate is being handled.

<sup>28</sup> Refer to the notes for use on the container.



## Coolants

The engine coolant is a mixture of water and anticorrosion/antifreeze, which provides:

- Corrosion protection
- Freeze protection
- Boiling protection (by increasing the boiling point)

The cooling system was filled at the factory with a coolant providing freeze protection to approximately  $-35^{\circ}\text{F}$  ( $-37^{\circ}\text{C}$ ) and corrosion protection.

- !** Add premixed coolant solution only. Adding water and MB 325.0 Anticorrosion/Antifreeze separately from each other, could cause engine damage not covered by the smart Limited Warranty.

If the antifreeze mixture is effective to  $-35^{\circ}\text{F}$  ( $-37^{\circ}\text{C}$ ), the boiling point of the coolant in the pressurized cooling system is reached at approximately  $266^{\circ}\text{F}$  ( $130^{\circ}\text{C}$ ).

The coolant solution must be used year round, even in countries which have high temperatures to provide the necessary corrosion protection and increase boil-over protection. Refer to Maintenance/ Service Booklet for replacement interval.

Coolant system design and coolant used determine the replacement interval. The replacement interval published in the Maintenance booklet is only applicable if MB 325.0 Anticorrosion/Antifreeze solution or other smart approved products of equal specification are used to renew the coolant concentration or bring it back up to the proper level.

For information on other smart approved products of equal specification, contact an authorized smart center.

To provide important corrosion protection, the solution must be at least 50% anticorrosion/antifreeze (equivalent to freeze protection to approximately  $-35^{\circ}\text{F}$  [ $-37^{\circ}\text{C}$ ]).

If you use a solution that is more than 55% anticorrosion/antifreeze (freeze protection to approximately  $-49^{\circ}\text{F}$  [ $-45^{\circ}\text{C}$ ]), the engine temperature will increase due to the lower heat transfer capability of the solution. Therefore, do not use more than this amount of anticorrosion/antifreeze.

If the coolant level is low, water and MB 325.0 Anticorrosion/Antifreeze should be used to bring it up to the proper level (have cooling system checked for signs of leakage). Please make sure the mixture is in accordance with label instructions.

Always use anticorrosion/antifreeze that has been approved by smart. For information contact an authorized smart center.

The water in the cooling system must meet minimum requirements, which are usually satisfied by normal drinking water.

If you are not sure about the water quality, consult an authorized smart center.

## Anticorrosion/antifreeze

Your vehicle contains a number of aluminum parts. The use of aluminum components in motor vehicle engines necessitates that anticorrosion/antifreeze coolant used in such engines be specifically formulated to protect the aluminum parts.

Failure to use such anticorrosion/antifreeze coolant will result in a significantly shortened service life.

Therefore, the following product is strongly recommended for use in your vehicle: MB 325.0 Anticorrosion/Antifreeze agent.

Before the start of the winter season (or once a year in hot southern regions), you should have the anticorrosion/antifreeze concentration checked.

The coolant is also regularly checked each time you bring your vehicle to an authorized smart center for service.

Anticorrosion/antifreeze quantity:

	Approximate freeze protection	
	-35°F (-37°C)	-49°F (-45°C)
Cooling system	2.27 US qt (2.15 l)	2.50 US qt (2.37 l)



>> Technical data.