



R-Class

Operator's Manual



Mercedes-Benz

Symbols

Registered trademarks:

- BabySmart™ is a registered trademark of the Siemens Automotive Corp.
- Bluetooth® is a registered trademark of the Bluetooth SIG Inc.
- DTS is a registered trademark of DTS, Inc.
- Dolby and MLP are registered trademarks of Dolby Laboratories.
- ESP® and PRE-SAFE® are registered trademarks of Daimler AG.
- HomeLink® is a registered trademark of Prince, a Johnson Controls Company.
- iPod® and iTunes® are registered trademarks of Apple Inc., registered in the USA and in other countries.
- Logic 7® is a registered trademark of Harman International Industries, Incorporated.
- Microsoft® is a registered trademark of the Microsoft Corporation in the USA and in other countries.
- SIRIUS and associated brands are registered trademarks of SIRIUS XM Radio Inc.
- HD Radio and associated brands are registered trademarks of the iBiquity Digital Corporation.
- Windows Media® is a registered trademark of the Microsoft Corporation in the USA and in other countries.
- Gracernote® is a registered trademark of Gracernote, Inc.
- ZagatSurvey® and associated brands are registered trademarks of Zagat.

In this Operator's Manual, you will find the following symbols:

WARNING

Warning notes draw your attention to hazards that endanger your health or life, or the health or life of others.

 These warning notes draw your attention to hazards that could cause damage to your vehicle.

 This symbol indicates useful instructions or further information that could be helpful to you.

▶ This symbol designates an instruction you must follow.

▶ Several consecutive symbols indicate an instruction with several steps.

▷ Page This symbol tells you where you can find further information on a topic.

▷▷ This symbol indicates a warning or an instruction that is continued on the next page.

Display This font indicates a display message in the multifunction display/COMAND display.

Parts of the software in the vehicle are subject to copyright according to © 2005 The FreeType Project <http://www.freetype.org>. All rights reserved.

Welcome to the world of Mercedes-Benz

Before you drive off, please familiarize yourself with your vehicle and read this manual, especially the safety and warning notes. This will help you to obtain the maximum pleasure from your vehicle and avoid endangering yourself and others.

The equipment or model designation of your vehicle may differ according to:

- model
- order
- country variant
- availability

Mercedes-Benz is constantly updating its vehicles to the state of the art.

Mercedes-Benz therefore reserves the right to introduce changes in the following areas:

- design
- equipment
- technical features

Therefore, you cannot base any claims on the illustrations or text content in this Operator's Manual.

The following are integral components of the vehicle:

- Operator's Manual
- Brief Instructions¹
- Service Booklet
- Equipment-dependent supplements

Keep these documents in the vehicle at all times. When you sell the vehicle, always pass the documents on to the new owner.

The technical documentation team at Daimler AG wishes you safe and pleasant motoring.

Mercedes-Benz USA, LLC

Mercedes-Benz Canada, Inc.

A Daimler Company

¹ Canada only.

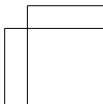
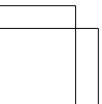
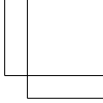
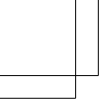

Index	4	At a glance	27
Introduction	21	Safety	37
		Opening/closing	71
		Seats, steering wheel and mirrors	95
		Lights and windshield wipers	113
		Climate control	129
		Driving and parking	143
		On-board computer and displays	197
		Stowing and features	247
		Maintenance and care	281
		Breakdown assistance	295
		Wheels and tires	321
		Technical data	351

1, 2, 3 ...

115 V socket	268
12 V socket	
see Sockets	
4ETS (Electronic Traction System)	66

A

ABS (Anti-lock Braking System)	
Display message	214
Function/notes	65
Important safety notes	65
Warning lamp	240
Activating/deactivating cooling with air dehumidification	135
Active service system PLUS	
see ASSYST PLUS service interval display	
Adaptive Damping System (ADS)	181
Additives (engine oil)	358
Adjusting the armrest (2nd row of seats)	102
ADS (Adaptive Damping System)	181
Air bags	
Display message	220
Front air bag (driver, front passenger)	42
Important safety notes	40
Safety guidelines	39
Side impact air bag	42
Window curtain air bag	43
Air-conditioning system	
see Climate control	
Air filter (display message)	228
AIRMATIC (display message)	229
AIRMATIC package	180
Air pressure	
see Tire pressure	
Air vents	
Important safety notes	141
Rear	142
Setting	141
Setting the center air vents	141
Setting the side air vents	141
Alarm system	
see ATA (Anti-Theft Alarm system)	

Anti-lock Braking System

 see ABS (Anti-lock Braking System)

Anti-Theft Alarm system

 see ATA (Anti-Theft Alarm system)

Anti-theft system

 ATA (Anti-Theft Alarm system)

 265

ASSYST PLUS

 see ASSYST PLUS service interval display

ATA (Anti-Theft Alarm system)

 Activating/deactivating

 69

 Function

 69

 Switching off the alarm

 69

Audio menu (on-board computer)

203

Audio system

 see separate operating instructions

Authorized Mercedes-Benz Center

 see Qualified specialist workshop

AUTO lights

 Display message

 225

 see Lights

Automatic headlamp mode

115

Automatic transmission

 Automatic drive program

 154

 Changing gear

 152

 DIRECT SELECT lever

 150

 Display message

 234

 Driving tips

 153

 Emergency running mode

 156

 Kickdown

 153

 Problem (malfunction)

 156

 Program selector button

 153

 Pulling away

 147

 Shift ranges

 154

 Starting the engine

 146

 Steering wheel paddle shifters

Automatic transmission

emergency mode

156

B**Back support**

see Lumbar support

Backup lamp

Changing bulbs 123

Display message 224

BAS (Brake Assist System) 65**Basic settings**

see Settings

Battery (key)

Checking 76

Battery (SmartKey)

Important safety notes 76

Replacing 76

Battery (vehicle)

Charging 312

Display message 227

Important safety notes 310

Jump starting 313

Belt

see Seat belts

Blind Spot Assist

Activating/deactivating 210

Display message 230

Notes/function 189

Trailer towing 191

BlueTEC

Adding DEF 161

BlueTEC (DEF) 357**Brake Assist System**

see BAS (Brake Assist System)

Brake fluid

Display message 217

Notes 359

Brake fluid level 286**Brake lamps**

Display message 223

Brakes

ABS 65

BAS 65

Brake fluid (notes) 359

Display message 214

Driving tips 166

Important safety notes 166

Maintenance 167

Parking brake 164, 168

Warning lamp 239

Breakdown

see Flat tire

see Towing away

Bulbs

see Changing bulbs

C**California**

Important notice for retail
customers and lessees 22

Calling up a malfunction

see Display messages

Capacities

see Technical data

Car

see Vehicle

Care

Carpets 294

Car wash 288

Display 292

Exterior lights 291

Gear or selector lever 293

Matte finish 290

Notes 287

Paint 290

Plastic trim 292

Power washer 289

Rear view camera 292

Roof lining 294

Seat belt 293

Seat cover 293

Sensors 291

Steering wheel 293

Tail pipes 292

Trim pieces 293

Washing by hand 289

Wheels 289

Windows 291

Wiper blades 291

Wooden trim 293

Cargo compartment cover

Extending 260

Notes/how to use 258

Cargo compartment enlargement

Full 253

Important safety notes 253

Partial 253

- Cargo compartment floor** 296
- Cargo net**
 - Attaching 261
 - Important safety information 260
- Cargo tie down rings** 257
- Car wash (care)** 288
- CD player/CD changer (on-board computer)** 203
- Cell phone**
 - see Mobile phone
- Center console**
 - 2nd row of seats 251
 - Lower section 33
 - Upper section 32
- Central locking**
 - Automatic locking (on-board computer) 208
 - Locking/unlocking (SmartKey) 72
- Changing bulbs**
 - High-beam headlamps 122
 - Important safety notes 119
 - License plate lighting 124
 - Low-beam headlamps 121
 - Overview of bulb types 120
 - Parking lamps 122
 - Removing/replacing the cover (front wheel arch) 121
 - Reversing lamps 123
 - Side marker lamps 123
 - Standing lamps (front) 122
 - Turn signals (front) 122
- Child-proof locks**
 - Important safety notes 63
 - Rear doors 63
- Children**
 - In the vehicle 56
 - Restraint systems 56
- Child seat**
 - LATCH-type (ISOFIX) child seat anchors 58
 - Special seat belt retractor 58
 - Top Tether 60
- Cigarette lighter** 266
- Classification system for occupants (OCS)**
 - Faults 48
 - Operation 44
 - System self-test 47
- Climate control**
 - Automatic climate control (3-zone) 132
 - Controlling automatically 136
 - Cooling with air dehumidification . . 135
 - Defrosting the windshield 138
 - Demisting the windows 139
 - Dual-zone automatic climate control 131
 - Important safety notes 130
 - Indicator lamp 136
 - Notes on using automatic climate control 131, 134
 - Overview of systems 130
 - Problems with cooling with air dehumidification 136
 - Problem with the rear window defroster 139
 - Rear control panel 132
 - Refrigerant 359
 - Setting the air distribution 138
 - Setting the airflow 138
 - Setting the air vents 141
 - Setting the temperature 137
 - Switching air-recirculation mode on/off 140
 - Switching on/off 134
 - Switching residual heat on/off 140
 - Switching the MONO function on/off 138
 - Switching the rear window heating on/off 139
- Clock (on-board computer)** 206
- Cockpit**
 - Overview 28
 - see Instrument cluster
- Collapsible spare wheel**
 - Inflating 307
 - see Emergency spare wheel
- COMAND**
 - see separate operating instructions
- Combination switch** 117
- Compass**
 - Calling up 278
- Consumption statistics (on-board computer)** 210
- Convenience closing feature** 88
- Convenience opening feature** 87

- Coolant (engine)**
 - Checking the level 285
 - Display message 225
 - Notes 359
 - Temperature gauge 202
 - Cooling**
 - see Climate control
 - Crash-responsive emergency lighting** 119
 - Cruise control**
 - Cruise control lever 171
 - Deactivating 172
 - Display message 230
 - Driving system 170
 - Function/notes 170
 - Important safety notes 170
 - LIM indicator lamp 171
 - Setting a speed 172
 - Storing and maintaining current speed 171
 - Cup holder**
 - Center console 263
 - Important safety notes 262
 - second row of seats 263
 - Second row of seats (armrest) 264
 - third row of seats 264
 - Customer Assistance Center (CAC)** ... 24
 - Customer Relations Department** 24
- D**
- Dashboard**
 - see Cockpit
 - Date (on-board computer)** 206
 - Daytime running lamp mode**
 - see Daytime running lamps
 - Daytime running lamps**
 - Display message 224
 - Switching on/off (on-board computer) 206
 - Switching on/off (switch) 115
 - DEF**
 - Adding 161
 - Display message 228
 - Delayed switch-off**
 - Exterior lighting (on-board computer) 207
 - Interior lighting 208
 - Diesel particle filter** 166
 - Digital speedometer**
 - Displaying 202
 - Setting the unit (on-board computer) 205
 - DIRECT SELECT lever**
 - see Automatic transmission
 - Display (cleaning instructions)** 292
 - Display messages**
 - Calling up (on-board computer) 213
 - Driving systems 229
 - Engine 225
 - General notes 213
 - Hiding (on-board computer) 213
 - Key 236
 - KEYLESS-GO 236
 - Lights 222
 - Safety systems 214
 - Service interval display 287
 - Tires 231
 - Vehicle 234
 - Distance recorder** 202
 - see Odometer
 - see Trip odometer
 - Distance warning (warning lamp)** 245
 - Distance warning function (vehicles with DISTRONIC)**
 - Activating/deactivating (on-board computer) 210
 - Notes 68
 - DISTRONIC**
 - Deactivating 178
 - Display message 230
 - Displays in the multifunction display 178
 - Driving tips 179
 - Important safety notes 173
 - Notes/function 173
 - Setting the specified minimum distance 177
 - Warning lamp 245
 - Door**
 - Central locking/unlocking (key) 72
 - Control panel 35
 - Important safety notes 79

- Doors**
 - Automatic locking (on-board computer) 208
 - Automatic locking (switch) 80
 - Display message 235
 - Emergency locking 81
 - Emergency unlocking 81
 - Opening (from inside) 80
 - Drinking and driving** 165
 - Drinks holder**
 - see Cup holders
 - Drive program (automatic)** 154
 - Driver's door**
 - see Doors
 - Driver's seat**
 - see Seats
 - Driving abroad**
 - Mercedes-Benz Service 287
 - Symmetrical low beam 114
 - Driving on flooded roads** 168
 - Driving safety systems**
 - 4ETS (Electronic Traction System) ... 66
 - ABS (Anti-lock Braking System) 65
 - BAS (Brake Assist System) 65
 - Distance warning system (vehicles with DISTRONIC) 68
 - Electronic brake force distribution ... 68
 - ESP® (Electronic Stability Program) 66
 - Important safety information 64
 - Overview 64
 - Driving systems**
 - Blind Spot Assist 189
 - Cruise control 170
 - Display message 229
 - DISTRONIC 173
 - Level control 181
 - PARKTRONIC 184
 - Rear axle level control 180
 - Rear view camera 187
 - Driving tips**
 - Automatic transmission 153
 - Brakes 166
 - Break-in period 144
 - DISTRONIC 179
 - Downhill gradient 166
 - Drinking and driving 165
 - Driving abroad 114
 - Driving on flooded roads 168
 - Driving on wet roads 168
 - Exhaust check 166
 - Fuel 165
 - General 165
 - Hydroplaning 168
 - Icy road surfaces 170
 - Limited braking efficiency on salted roads 167
 - Pedals 165
 - Snow chains 169, 325
 - Symmetrical low beam 114
 - Towing a trailer 191
 - Wet road surface 167
 - DVD audio (on-board computer)** 203
- E**
- EASY-ENTRY feature**
 - 3rd row of seats 103
 - Activating/deactivating 209
 - Function/notes 108
 - EASY-EXIT feature**
 - 3rd row of seats 103
 - Crash-responsive 109
 - Function/notes 108
 - Switching on/off 209
 - EBD (electronic brake force distribution)**
 - Display message 216
 - Function/notes 68
 - Electrical fuses**
 - see Fuses
 - Electronic Brake force Distribution**
 - see EBD (Electronic Brake force Distribution)
 - Electronic Stability Program**
 - see ESP® (Electronic Stability Program)
 - Electronic Traction System**
 - see ETS/4ETS (Electronic Traction System)
 - Emergency release**
 - Driver's door 81
 - Fuel filler flap 158
 - Vehicle 81

- Emergency spare wheel**
 - Storage location 297
 - Stowing 298
 - Emergency Tensioning Devices**
 - Function 55
 - Safety guidelines 39
 - Emissions purification**
 - Service and warranty information 21
 - Engine**
 - Check Engine warning lamp 244
 - Display message 225
 - Emergency starting 317
 - Engine number 354
 - Irregular running 149
 - Starting problems 149
 - Starting the engine with the SmartKey 146
 - Starting with KEYLESS-GO 147
 - Switching off 163
 - Engine electronics**
 - Problem (malfunction) 149
 - Engine emergency stop** 319
 - Engine oil**
 - Adding 284
 - Additives 358
 - Checking the oil level 283
 - Display message 227
 - Filling capacity 355
 - Notes about oil grades 358
 - Notes on oil level/consumption 283
 - Viscosity 359
 - ESP® (Electronic Stability Program)**
 - 4ETS 66
 - Deactivating/activating 66
 - Display message 214
 - Function/notes 66
 - Important safety information 66
 - Trailer stabilization 67
 - Warning lamp 241
 - Exhaust check** 166
 - Exhaust tail pipe (cleaning instructions)** 292
 - Exterior lighting**
 - see Lights
 - Exterior mirrors**
 - Adjusting 110
 - Dipping (automatic) 111
 - Folding in/out (automatically) 110
 - Folding in/out (electrically) 110
 - Folding in when locking (on-board computer) 209
 - Out of position (troubleshooting) ... 111
 - Setting 110
 - Storing settings (memory function) 112
 - Storing the parking position 111
- F**
- Filler cap**
 - see Fuel filler flap
 - First-aid kit** 296
 - Flat tire**
 - Changing a wheel/mounting the spare wheel 303
 - MOExtended run-flat system 309
 - Preparing the vehicle 299
 - Raising the vehicle 305
 - TIREFIT kit 299
 - see Emergency spare wheel
 - Floormat** 279
 - Front fog lamp**
 - Switching on/off 116
 - Front fog lamps** 116
 - Display message 224
 - Front windshield**
 - see Windshield
 - Fuel**
 - Additives 357
 - Calling up the range 211
 - Consumption statistics 210
 - Displaying the current consumption 211
 - Driving tips 165
 - Fuel gauge 29
 - Important safety notes 356
 - Premium-grade unleaded gasoline . 356
 - Problem (malfunction) 160
 - Refueling 156
 - Specifications 356
 - Tank content/reserve fuel 355

- Fuel filler flap**
 Emergency release 158
 Opening/closing 158
Fuel filter (display message) 228
- Fuel level**
 Calling up the range (on-board computer) 211
- Fuel tank**
 Capacity 355
 Problem (malfunction) 160
- Fuse allocation chart (vehicle tool kit)** 296
- Fuses**
 Allocation chart 317
 Before changing 317
 Dashboard fuse box 318
 Engine emergency stop 319
 Fuse box in the cargo compartment 318
 Fuse box in the engine compartment 318
 Important safety notes 317
- G**
- Garage door opener**
 Clearing the memory 278
 Notes 275
 Opening/closing the garage door .. 278
 Programming (button in the rear-view mirror) 276
- Gasoline** 157
- Gear or selector lever (cleaning guidelines)** 293
- Genuine Mercedes-Benz parts** 352
- Glove box** 249
- GTW (Gross Trailer Weight) (definition)** 344
- H**
- Handbrake**
 see Parking brake
- Hazard warning lamps** 117
- Headlamp cleaning system**
 Notes 360
- Headlamp delayed switch-off**
 see Exterior lighting delayed switch-off
- Headlamps**
 Adding fluid to cleaning system 285
 Cleaning system (function) 117
 Misting up 118
 see Automatic headlamp mode
- Head restraints**
 Adjusting 99
 Adjusting (electrically) 99
 Adjusting (manually) 99
 Adjusting (rear) 100
 Installing/removing (rear) 100
 Luxury 99
 see NECK-PRO head restraints/
 NECK-PRO luxury head restraints
- Heating**
 see Climate control
- High-beam headlamps**
 Changing bulbs 122
 Display message 223
 Switching on/off 117
- Hill start assist** 147
- Hood**
 Closing 283
 Display message 235
 Opening 282
- Hydroplaning** 168
- I**
- Ignition lock**
 see SmartKey positions
- Immobilizer** 68
- Indicator and warning lamps**
 DISTRONIC 245
- Indicator lamps**
 see Warning and indicator lamps
- Insect protection on the radiator** 283
- Instrument cluster**
 Overview 29
 Selecting the language (on-board computer) 206
 Settings 205
 Warning and indicator lamps 30
- Instrument cluster lighting** 29
- Instrument lighting**
 see Instrument cluster lighting
- Interior lighting**
 Automatic control 119

Delayed switch-off (on-board computer)	208
Emergency lighting	119
Manual control	119
Overview	118
Reading lamp	118
see Interior lighting	

J**Jack**

Storage location	296
Using	305

Jump starting (engine)	313
-------------------------------------	-----

K**Key**

see SmartKey

KEYLESS-GO

Convenience closing feature	88
Display message	236
Locking	73
Start/Stop button	145
Starting the engine	147
Unlocking	73

Key positions

KEYLESS-GO	145
SmartKey	145

Kickdown	153
-----------------------	-----

L**Lamps**

see Warning and indicator lamps

Lane-change assistant

see Blind Spot Assist

Language (on-board computer)	206
---	-----

LATCH-type (ISOFIX) child seat anchors	58
---	----

Level control (display message)	229
--	-----

License plate lamp

Changing bulbs	124
Display message	223

Lighting

see Lights

Lights

Activating/deactivating the exterior lighting delayed switch-off	207
--	-----

Activating/deactivating the interior lighting delayed switch-off .	208
--	-----

Automatic headlamp mode	115
-------------------------------	-----

Display message	222
-----------------------	-----

Driving abroad	114
----------------------	-----

Fog lamps	116
-----------------	-----

Hazard warning lamps	117
----------------------------	-----

High beam flasher	117
-------------------------	-----

High-beam headlamps	117
---------------------------	-----

Light switch	114
--------------------	-----

Low-beam headlamps	115
--------------------------	-----

Parking lamps	114
---------------------	-----

Rear fog lamp	116
---------------------	-----

Switching the daytime running lamps on/off (on-board computer)	206
--	-----

Switching the daytime running lamps on/off (switch)	115
---	-----

Switching the surround lighting on/off (on-board computer)	207
--	-----

Turn signals	117
--------------------	-----

see Changing bulbs

see Interior lighting

Light sensor (display message)	225
---	-----

LIM indicator lamp

Cruise control	171
----------------------	-----

DISTRONIC	175
-----------------	-----

Loading guidelines	248
---------------------------------	-----

Locking

see Central locking

Locking (doors)

Automatic	80
-----------------	----

Emergency locking	81
-------------------------	----

From inside (central locking button)	80
--	----

Locking centrally

see Central locking

Locking verification signal (on-board computer)	208
--	-----

Low-beam headlamps

Changing bulbs	121
----------------------	-----

Display message	222
-----------------------	-----

- Setting for driving abroad (symmetrical) 114
 - Switching on/off 115
 - Luggage net** 251
 - Lumbar support**
 - Adjusting the 4-way lumbar support 105
 - Luxury head restraints** 99
- M**
- M+S tires** 169, 324
 - Maintenance**
 - see ASSYST PLUS service interval display
 - Malfunction message**
 - see Display messages
 - Malfunctions relevant to safety**
 - Reporting 24
 - Matte finish (cleaning instructions)** 290
 - mbrace**
 - Call priority 273
 - Display message 218
 - Downloading destinations (COMAND) 273
 - Emergency call 270
 - Important safety notes 269
 - Locating a stolen vehicle 275
 - MB info call button 272
 - Roadside Assistance button 272
 - Search & Send 274
 - Self-test 270
 - System 270
 - Vehicle remote unlocking 274
 - Mechanical key**
 - Function/notes 75
 - Unlocking the driver's door 81
 - Memory card (audio)** 203
 - Memory function** 112
 - Messages**
 - see Display messages
 - Mirrors**
 - see Exterior mirrors
 - see Rear-view mirror
 - see Vanity mirror
 - Mobile phone**
 - Menu (on-board computer) 211
 - Modifying the programming (SmartKey)** 75
 - MOExtended run-flat system** 309
 - MP3**
 - Operating 203
 - see separate operating instructions
 - Multicontour seat** 105
 - Multifunction display** 200
 - Multifunction steering wheel**
 - Operating the on-board computer . 199
 - Overview 31
- N**
- Navigation**
 - Menu (on-board computer) 204
 - On-board computer 204
 - see separate operating instructions
 - NECK-PRO head restraints**
 - Operation 49
 - Resetting after being triggered 50
 - NECK-PRO luxury head restraints**
 - Operation 49
 - Resetting after being triggered 50
 - Notes on breaking-in a new vehicle** 144
- O**
- Occupant Classification System (OCS)**
 - Faults 48
 - Operation 44
 - System self-test 47
 - Occupant safety**
 - Children in the vehicle 56
 - System overview 38
 - Octane number (fuel)** 356
 - Odometer** 202
 - see Trip odometer
 - Off-road system**
 - 4MATIC 183
 - Oil**
 - see Engine oil
 - On-board computer**
 - Additional functions menu 210
 - AIRMATIC/compass menu 204
 - Audio menu 203

- Convenience submenu 209
 - Displaying a service message 287
 - Displaying the coolant temperature 202
 - Displaying the outside temperature 202
 - Display messages 213
 - DISTRONIC menu 178
 - Factory settings 205
 - Important safety notes 198
 - Instrument cluster submenu 205
 - Lighting submenu 206
 - Menu overview 201
 - Message memory menu 213
 - Navigation menu 204
 - Operating video DVD 204
 - Operation 199
 - Selecting the language 206
 - Settings menu 205
 - Standard display 202
 - Status bar 206
 - Telephone menu 211
 - Time/Date submenu 206
 - Trip computer menu 210
 - Vehicle submenu 208
 - Opening and closing the side trim panels** 123
 - Operating system**
see On-board computer
 - Outside temperature**
Calling up (on-board computer) 202
Display 198
 - Overhead control panel** 34
 - Override feature**
Rear side windows 63
- P**
- Paint code number** 353
 - Paintwork (cleaning instructions)** ... 290
 - Panic alarm** 64
 - Panorama roof with power tilt/sliding panel**
Opening/closing 91
Opening/closing the roller sunblind 91
Problem (malfunction) 92
Resetting 92
 - Panorama sliding sunroof**
Important safety notes 89
 - Parking**
Important safety notes 163
Parking brake 164
Position of exterior mirror, front-passenger side 111
Rear view camera 187
see Parking
see PARKTRONIC
 - Parking aid**
see Exterior mirrors
see PARKTRONIC
 - Parking brake**
Display message 217
Notes/function 164
see Parking brake
 - Parking lamps (changing bulbs)** 122
 - PARKTRONIC**
Deactivating/activating 186
Driving system 184
Function/notes 184
Problem (malfunction) 187
Range of the sensors 184
Trailer towing 186
Warning display 185
 - Pedals** 165
 - Permanent four-wheel drive**
see 4MATIC (permanent four-wheel drive)
 - Plastic trim (cleaning instructions)** . 292
 - Power washers** 289
 - Power windows**
see Side windows
 - PRE-SAFE® (Preventive occupant safety system)**
Display message 218
Operation 49
 - PRE-SAFE® Brake (vehicles with DISTRONIC PLUS)**
Warning lamp 245
 - Preventive occupant safety system**
see PRE-SAFE® (Preventive occupant safety system)
 - Product information** 21
 - Program selector button** 153

Pulling away (automatic transmission) 147

Q

Qualified specialist workshop 24

R

Radar sensor system
Activating/deactivating 208

Radiator cover 283

Radio

Selecting a station 203
see separate operating instructions

Radio-controlled devices (installing) 279

Reading lamp 118

Rear axle level control 180

Rear bench seat

Folding forwards/back 253

Rear compartment

Activating/deactivating climate control 134
Setting the air vents 142
Setting the temperature 137

Rear-compartment seat

see Rear seat

Rear fog lamp

Display message 224
Switching on/off 116

Rear lamps

see Lights

Rear seat

Adjusting 101

Rear view camera

Cleaning instructions 292
Function/notes 187

Rear-view mirror

Anti-glare (manual) 109
Dipping (automatic) 111

Rear window defroster

Problem (malfunction) 139

Rear window heating

Switching on/off 139

Rear window wiper

Replacing the wiper blade 126
Switching on/off 125

Refueling

Fuel gauge 29
Important safety notes 156
Refueling process 158
see Fuel

Remote control

Garage door opener 275

Reporting

Malfunctions relevant to safety 24

Reserve (fuel tank)

see Fuel

Reserve fuel

Display message 228
Warning lamp 244
see Fuel

Reset button 29

Residual heat (climate control) 140

Restraint system

see SRS (Supplemental Restraint System)

Roadside Assistance (breakdown) 22

Roller blind

see Roller sunblind

Roller sunblind

Panorama roof with power tilt/
sliding panel 91
Rear side windows 265

Roof carrier 262

Roof lining and carpets (cleaning guidelines) 294

Roof load (maximum)

see Technical data

Route

see Route guidance (navigation)

Route guidance (navigation) 204

S

Safety

Children in the vehicle 56
Child restraint systems 56
Occupant Classification System (OCS) 44
Overview of occupant safety systems 38

Safety systems

see Driving safety systems

Seat

- Folding down the 2nd row of seats 254
- Important safety notes 97
- Resetting the 2nd row of seats 256
- Resetting the 3rd row of seats 256

Seat belts

- Adjusting the driver's and front-passenger seat belt 54
- Adjusting the height 54
- Belt force limiters 55
- Cleaning 293
- Correct usage 52
- Emergency Tensioning Devices 55
- Fastening 53
- Important safety guidelines 51
- Releasing 54
- Safety guidelines 39
- Special seat belt retractor 58
- Switching belt adjustment on/off (on-board computer) 209
- Warning lamp 238
- Warning lamp (function) 54

Seats

- Adjusting (electrically) 98
- Adjusting (second and third rows) . 101
- Adjusting the 4-way lumbar support 105
- Adjusting the head restraint 99
- Cleaning the cover 293
- Correct driver's seat position 96
- Folding down the 3rd row of seats . 255
- Folding the rear bench seat forwards/back 253
- Multicontour seat 105
- Seat heating problem 106
- Seat ventilation problem 107
- Storing settings (memory function) 112
- Switching seat heating on/off 106
- Switching the seat ventilation on/off 106

Securing hooks 258**Sensors (cleaning instructions)** 291**Service**

- see ASSYST PLUS service interval display

Service interval display

- Displaying service messages 287
- Hiding service messages 287
- Notes 287
- Service messages 287

Service products

- Brake fluid 359
- Capacities 355
- Coolant (engine) 359
- DEF special additives 357
- Engine oil 358
- Fuel 356
- Important safety notes 354
- Refrigerant (air-conditioning system) 359
- Washer fluid 360

Settings

- Factory (on-board computer) 205
- On-board computer 205

Setting the air distribution 138**Setting the airflow** 138**Side impact air bag** 42**Side marker lamp (display message)** 224**Side marker lamps (changing bulbs)** 123**Side windows**

- Convenience closing feature 88
- Convenience opening feature 87
- Hinged side windows 87
- Important safety information 86
- Opening/closing 86
- Problem (malfunction) 89
- Resetting 89

Sliding sunroof

- Important safety notes 89
- Opening/closing 90
- Problem (malfunction) 92
- Resetting 90
- see Panorama roof with power tilt/sliding panel

SmartKey

- Changing the battery 76
- Changing the programming 75
- Checking the battery 76
- Convenience closing feature 88
- Convenience opening feature 87
- Display message 236

- Door central locking/unlocking 72
 - Important safety notes 72
 - Loss 78
 - Mechanical key 75
 - Positions (ignition lock) 145
 - Problem (malfunction) 78
 - Starting the engine 146
 - Snow chains** 169, 325
 - Sockets**
 - 2nd row of seats 268
 - Center console 268
 - Front-passenger footwell 268
 - Luggage compartment 268
 - Points to observe before use 267
 - Spare wheel**
 - Notes/data 349
 - Storage location 297
 - Stowing 298
 - see Emergency spare wheel
 - Specialist workshop** 24
 - Speed, controlling**
 - see Cruise control
 - Speedometer**
 - Additional speedometer (on-board computer) 202
 - In the Instrument cluster 29
 - Segments 199
 - Selecting the unit of measurement 205
 - see Instrument cluster
 - SRS (Supplemental Restraint System)**
 - Display message 218
 - Introduction 38
 - Warning lamp 243
 - Warning lamp (function) 38
 - Standing lamps**
 - Changing bulbs 122
 - Display message 224
 - Switching on/off 114
 - Starting (engine)** 146
 - Station**
 - see Radio
 - Steering (display message)** 235
 - Steering wheel**
 - Adjusting (electrically) 108
 - Adjusting (manually) 107
 - Button overview 31
 - Buttons (on-board computer) 199
 - Important safety notes 107
 - Paddle shifters 153
 - Steering wheel heating 108
 - Storing settings (memory function) 112
 - Steering wheel (cleaning instructions)** 293
 - Steering wheel heating**
 - Indicator lamp (malfunction) 108
 - Switching on/off 108
 - Steering wheel paddle shifters** 153
 - Stowage compartments**
 - 3rd row of seats 250
 - Armrest (under) 250
 - Center air vents (2nd row of seats) 250
 - Center console (2nd row of seats) . 250
 - Glove box 249
 - Parcel net 251
 - Stowage space**
 - Center console 249
 - Cup holders 262
 - Important safety information 248
 - Summer opening**
 - see Convenience opening feature
 - Summer tires** 324
 - Sun visor** 264
 - Supplement Restraint System**
 - see SRS (Supplemental Restraint System)
 - Surround lighting (on-board computer)** 207
 - Switching air-recirculation mode on/off** 140
 - Switching off the alarm (ATA)** 69
- T**
- Tachometer** 198
 - Tailgate**
 - Display message 235
 - Important safety notes 81
 - Limiting the opening angle 85
 - Opening/closing (automatically from inside) 84

- Opening/closing (automatically from outside) 83
- Opening/closing (from outside) 82
- Tail lamps**
 - Display message 224
 - see Lights
- Tank**
 - see Fuel tank
- Tank content**
 - Fuel gauge 29
- Technical data**
 - R 350 361
 - R 350 BlueTEC 360
 - Tires/wheels 347
- TELEAID**
 - Call priority 273
 - Display message 218
 - Downloading destinations (COMAND) 273
 - Emergency call 270
 - Important safety notes 269
 - Locating a stolen vehicle 275
 - MB info call button 272
 - Roadside Assistance button 272
 - Search & Send 274
 - Self-test 270
 - System 270
 - Vehicle remote unlocking 274
- Telephone**
 - Accepting a call 211
 - Display message 235
 - Menu (on-board computer) 211
 - Number from the phone book 212
 - Redialing 212
 - Rejecting/ending a call 212
- Temperature**
 - Coolant (on-board computer) 202
 - Displaying the outside temperature 202
 - Outside temperature 198
 - Setting (climate control) 137
- Theft deterrent locking system**
 - Immobilizer 68
- Tilt/sliding sunroof**
 - see Sliding sunroof
- Time (on-board computer) 206**
- TIREFIT kit 299**
- Tire pressure**
 - Calling up (on-board computer) 331
 - Checking manually 329
 - Display message 231
 - Maximum 328
 - Notes 327
 - Not reached (TIREFIT) 302
 - Pressure loss warning 329
 - Reached (TIREFIT) 302
 - Recommended 325
- Tire pressure monitoring system**
 - Function/notes 331
 - Restarting 333
 - Warning lamp 245
- Tires**
 - Aspect ratio (definition) 345
 - Average weight of the vehicle occupants (definition) 343
 - Bar (definition) 343
 - Characteristics 343
 - Checking 323
 - Definition of terms 343
 - Direction of rotation 346
 - Display message 231
 - Distribution of the vehicle occupants (definition) 346
 - DOT, Tire Identification Number (TIN) 342
 - DOT (Department of Transportation) (definition) 343
 - GAWR (Gross Axle Weight Rating) (definition) 344
 - GTW (Gross Trailer Weight) (definition) 344
 - GVW (Gross Vehicle Weight) (definition) 344
 - GVWR (Gross Vehicle Weight Rating) (definition) 344
 - Important safety notes 322
 - Increased vehicle weight due to optional equipment (definition) 343
 - Kilopascal (kPa) (definition) 344
 - Labeling (overview) 339
 - Load bearing index (definition) 345
 - Load index 342
 - Load index (definition) 344
 - Maximum loaded vehicle weight (definition) 344

- Maximum load on a tire
(definition) 345
- Maximum permissible tire
pressure (definition) 344
- Maximum tire load 337
- Maximum tire load (definition) 344
- Optional equipment weight
(definition) 345
- PSI (pounds per square inch)
(definition) 345
- Replacing 346
- Service life 323
- Sidewall (definition) 345
- Speed index (definition) 344
- Storing 347
- Structure and characteristics
(definition) 343
- Temperature 339
- TIN (Tire Identification Number)
(definition) 345
- Tire bead (definition) 345
- Tire pressure (definition) 345
- Tire pressures (recommended) 343
- Tire size (data) 347
- Tire size designation, load-bearing
capacity, speed index 340
- Tire tread 323
- Tire tread (definition) 345
- Total load limit (definition) 346
- Traction 338
- Traction (definition) 345
- Tread wear 338
- TWR (permissible trailer drawbar
noseweight) (definition) 345
- Uniform Tire Quality Grading
Standards 338
- Uniform Tire Quality Grading
Standards (definition) 343
- Unladen weight (definition) 344
- Wear indicator (definition) 346
- Wheel rim (definition) 344
- see Flat tire
- Top Tether** 60
- Towing**
- Important safety guidelines 315
- Installing the towing eye 315
- Removing the towing eye 316
- Towing a trailer**
- Coupling up a trailer 192
- Decoupling a trailer 193
- Driving tips 191
- Important safety notes 191
- Lights display message 222
- Power supply 194
- Shift range 153
- Towing away**
- With both axles on the ground 316
- Tow-starting**
- Emergency engine starting 317
- Important safety notes 315
- Trailer**
- Towing 192
- Trailer loads and drawbar
noseweights** 194
- Trailer towing**
- Blind Spot Assist 191
- ESP® 67
- PARKTRONIC 186
- Permissible trailer loads and
 drawbar noseweights 194
- Towing a trailer 192
- Transmission**
- see Automatic transmission
- Transporting the vehicle** 316
- Trim pieces (cleaning instructions)** . 293
- Trip computer (on-board
computer)** 210
- Trip meter**
- see Trip odometer
- Trip odometer**
- Calling up 202
- Resetting (on-board computer) 211
- Trunk**
- see Tailgate
- Turn signals**
- Changing bulbs (front) 122
- Display message 222
- Switching on/off 117
- see Turn signals
- TWR (Tongue Weight Rating)
(definition)** 345
- Type identification plate**
- see Vehicle identification plate

U**Unlocking**

- Emergency unlocking 81
- From inside the vehicle (central unlocking button) 80

V**Vanity mirror (in sun visor) 265****Vehicle**

- Correct use 24
- Data acquisition 25
- Display message 234
- Equipment 21
- Individual settings 205
- Limited Warranty 25
- Loading 333
- Locking (in an emergency) 81
- Locking (SmartKey) 73
- Lowering 309
- Maintenance 22
- Parking for a long period 164
- Pulling away 147
- Raising 305
- Reporting problems 24
- Towing away 315
- Transporting 316
- Unlocking (in an emergency) 81
- Unlocking (SmartKey) 73

Vehicle battery

see Battery (vehicle)

Vehicle dimensions

see Technical data

Vehicle emergency locking 81**Vehicle identification number**

see VIN

Vehicle identification plate 353**Vehicle level (display message) 229****Vehicle tool kit 296****Vehicle weights**

see Technical data

Video (DVD) 204**Video DVD (on-board computer) 204****VIN 353****W****Warning and indicator lamps**

- ABS 240
- Brakes 239
- Check Engine 244
- Cruise control 171
- Distance warning 245
- ESP® 241
- ESP® OFF 242
- Fuel tank 244
- LIM (DISTRONIC) 175
- Overview 30
- Reserve fuel 244
- Seat belt 238
- SRS 243
- Tire pressure monitor 245

Warranty 352**Washer fluid**

- Display message 236
- see Windshield washer system

Weight

see Technical data

Wheel bolt tightening torque 309**Wheel chock 304****Wheels**

- Changing/replacing 346
- Changing a wheel 303
- Checking 323
- Cleaning 289
- Important safety notes 322
- Mounting a wheel 307
- Removing a wheel 306
- Storing 347
- Tightening torque 309
- Wheel size/tire size 347

Window curtain air bag 43**Windows**

- Cleaning 291
- see Side windows

Windshield

- Defrosting 138
- Infrared reflective 279

Windshield washer system 285

- Notes 360

Windshield wipers

- Problem (malfunction) 126
- Rear window wiper 125

Replacing the wiper blades	125
Switching on/off	124
Winter driving	
Important safety notes	324
Slippery road surfaces	170
Snow chains	169, 325
Winter operation	
Radiator cover	283
Winter tires	
M+S tires	169, 324
Wiper blades	
Cleaning	291
Important safety notes	125
Replacing (rear window)	126
Replacing (windshield)	126
Wooden trim (cleaning instructions)	293

Product information

Mercedes-Benz recommends that you use genuine Mercedes-Benz parts, conversion parts and accessories that have been approved for the type of vehicle.

Mercedes-Benz tests genuine parts as well as conversion parts and accessories which have been specifically approved for your vehicle for their reliability, safety and suitability. Despite ongoing market research, Mercedes-Benz is unable to assess other parts. Therefore, Mercedes-Benz accepts no responsibility for the use of such parts in Mercedes-Benz vehicles, even if they have been independently or officially approved. The use of non-approved parts could affect your vehicle's operating safety. Mercedes-Benz therefore recommends that you use genuine Mercedes-Benz parts, conversion parts and accessories that have been approved for the type of vehicle. Genuine Mercedes-Benz parts, approved conversion parts and accessories are available from any authorized Mercedes-Benz Center. Here, you will receive advice about permissible technical modifications, and the parts will be professionally installed.

Operator's Manual

Notes on the Operator's Manual

This Operator's Manual contains a great deal of helpful information. We urge you to read it carefully and familiarize yourself with the vehicle before driving.

For your own safety and longer service life of the vehicle, we urge you to follow the instructions and warnings contained in this Operator's Manual. Ignoring them could result in damage to the vehicle or personal injury to you or others. Vehicle damage caused by failure to follow instructions is not covered by the Mercedes-Benz Limited Warranty.

² Valid only for vehicles with a gasoline engine.

Vehicle equipment

This Operator's Manual describes all models and all standard and optional equipment of your vehicle available at the time of publication of the Operator's Manual. Country-specific differences are possible. Please note that your vehicle may not be equipped with all features described. This also applies to safety-related systems and functions. The equipment in your vehicle may therefore differ from that shown in the descriptions and illustrations. All the systems found in your vehicle are listed in the original purchase agreement of your vehicle. Should you have any questions concerning equipment and operation, please consult an authorized Mercedes-Benz Center.

The Operating Instructions and the Maintenance Booklet are important documents and should be kept in the vehicle.

Service and vehicle operation

Service and literature

Your vehicle is covered under the terms of the warranties printed in the Service and Warranty Information booklet. Your authorized Mercedes-Benz Center will exchange or repair any defective parts originally installed in the vehicle in accordance with the terms of the following warranties:

- New Vehicle Limited Warranty
- Emission Systems Warranty
- Emission Performance Warranty
- California, Connecticut, Maine, Massachusetts, New York, Pennsylvania, Rhode Island and Vermont Emission Control System Warranty²
- California, Connecticut, Maine, Massachusetts, New York, Pennsylvania,

Rhode Island and Vermont Emission Control Systems Warranty

- State Warranty Enforcement Laws (Lemon Laws)

Information for customers in California

Under California law you may be entitled to a replacement of your vehicle or a refund of the purchase price or lease price, if after a reasonable number of repair attempts Mercedes-Benz USA, LLC and/or its authorized repair or service facilities fail to fix one or more substantial defects or malfunctions in the vehicle that are covered by its express warranty. During the period of 18 months from original delivery of the vehicle or the accumulation of 18 000 miles (approximately 29 000 km) on the odometer of the vehicle, whichever occurs first, a reasonable number of repair attempts is presumed for a retail buyer or lessee if one or more of the following occurs:

- (1) the same substantial defect or malfunction results in a condition that is likely to cause death or serious bodily injury if the vehicle is driven, that defect or malfunction has been subject to repair two or more times, and you have directly notified Mercedes-Benz USA, LLC in writing of the need for its repair.
- (2) the same substantial defect or malfunction of a less serious nature than category (1) has been subject to repair four or more times and you have directly notified Mercedes-Benz in writing of the need for its repair.
- (3) the vehicle is out of service by reason of repair of the same or different substantial defects or malfunctions for a cumulative total of more than 30 calendar days.

Please send your written notice to:
Mercedes-Benz USA, LLC
Customer Assistance Center

One Mercedes Drive
Montvale, NJ 07645-0350

Maintenance

The Service and Warranty Booklet describes all the necessary maintenance work which should be done at regular intervals.

Always have the Service and Warranty Booklet with you when you bring the vehicle to an authorized Mercedes-Benz Center. The service advisor will record every service for you in the Service and Warranty Booklet.

Roadside Assistance

The Mercedes-Benz Roadside Assistance Program offers technical help in the event of a breakdown. Calls to the toll-free Roadside Assistance Hotline are answered by our agents 24 hours a day, 365 days a year.

1-800-FOR-MERCEdes(1-800-367-6372) (USA)

1-800-387-0100 (Canada)

For additional information, refer to the Mercedes-Benz Roadside Assistance Program brochure (USA) or the "Roadside Assistance" section in the Service and Warranty booklet (Canada). You will find both in your vehicle literature portfolio.

In accordance with standard program guidelines, Roadside Assistance provides vehicle service up to a reasonable distance from the next paved road. We will make every effort to assist in a breakdown situation. However, the accessibility of your vehicle will be determined by our authorized Mercedes-Benz Service technician or the tow service provider on a case-by-case basis.

Additional charges may be applicable for a breakdown location determined not to be a reasonably accessible roadside location as determined by our authorized technician and tow service provider.

Change of address or ownership

In the event of a change of address, please send us the "Change of Address Notice" found in the Service and Warranty Information Booklet, or simply call the Mercedes-Benz Customer Assistance Center (in the USA) at the hotline number 1-800-FOR-MERCEdes(1-800-367-6372) or Customer Service Center (in Canada) at 1-800-387-0100. This will assist us in contacting you in a timely manner should the need arise.

If you sell your Mercedes, please leave the entire literature in the vehicle so that it is available to the next owner.

If you bought this vehicle used, be sure to send in the "Notice of Purchase of Used Truck" found in the Service and Warranty Information Booklet, or call the Mercedes-Benz Customer Assistance Center (in the USA) at 1-800-FOR-MERCEdes(1-800-367-6372) or Customer Service (in Canada) at 1-800-387-0100.

Vehicle operation outside the USA and Canada

If you plan to operate your vehicle in foreign countries, please be aware that:

- service facilities or replacement parts may not be readily available.
- unleaded fuel for vehicles with a catalytic converter may not be available. Leaded fuel may cause damage to the catalytic converter.
- the fuel may have a considerably lower octane rating. Unsuitable fuel can cause engine damage.

Operating safety

Safety notes

WARNING

Work improperly carried out on electronic components and associated software could cause them to cease functioning. Because the vehicle's electronic components are interconnected, any modifications made may produce an undesired effect on other systems. Electronic malfunctions could seriously impair the operating safety of your vehicle.

Contact an authorized Mercedes-Benz Center for repairs or modifications to electronic components.

Other improper work or modifications on the vehicle could also have a negative impact on the operating safety of the vehicle.

Some safety systems only function when the engine is running. You should therefore never turn off the engine while driving.

WARNING

Heavy blows against the vehicle underbody or tires/wheels may cause serious damage and impair the operating safety of your vehicle. Such blows can be caused, for example, by running over an obstacle, road debris or a pothole.

If you feel a sudden significant vibration or ride disturbance, or you suspect that damage to your vehicle has occurred:

- turn on your hazard warning flashers.
- slow down carefully.
- drive with caution to an area which is a safe distance from the road.

Inspect the vehicle underbody and tires/wheels for possible damage. If the vehicle appears unsafe, have it towed to the nearest authorized Mercedes-Benz Center or other qualified maintenance or repair facility for further inspection or repairs.

Qualified specialist workshop

An authorized Mercedes-Benz Center is a qualified specialist workshop. It has the necessary specialist knowledge, tools and qualifications to correctly carry out the work required on your vehicle. This is especially the case for work relevant to safety.

Observe the notes in the service booklet.

Always have the following work carried out at an authorized Mercedes-Benz Center:

- work relevant to safety
- service and maintenance work
- repair work
- alterations, installation work and modifications
- work on electronic components

Proper use

WARNING

There are various warning stickers affixed to your vehicle. Their purpose is to alert you and others to various dangers. Therefore, do not remove any warning stickers unless the sticker clearly states that you may do so.

If you remove any warning stickers, you or others could fail to recognize certain dangers and be injured.

WARNING

HYBRID vehicles: It is imperative that you read the HYBRID Supplemental Operating Instructions included in your vehicle literature portfolio. You may otherwise not receive all necessary safety information and warning for the operation of your vehicle.

The proper use of the vehicle requires that you familiarize yourself with the following information and rules:

- safety notes in this Operator's Manual
- technical data in this Operator's Manual

- traffic rules and regulations
- laws and safety standards pertaining to motor vehicles

Problems with your vehicle

If you should experience a problem with your vehicle, particularly one that you believe may affect its safe operation, we urge you to contact an authorized Mercedes-Benz Center immediately to have the problem diagnosed and rectified. If the problem is not resolved to your satisfaction, please discuss the problem again with a Mercedes-Benz Center or contact us at one of the following addresses.

In the USA

Customer Assistance Center
Mercedes-Benz USA, LLC
One Mercedes Drive
Montvale, NJ 07645-0350

In Canada

Customer Relations Department
Mercedes-Benz Canada, Inc.
98 Vanderhoof Avenue
Toronto, Ontario M4G 4C9

Reporting malfunctions relevant to safety

For the USA only:

The following text is reproduced as required of all manufacturers according to Title 49, Code of U.S. Federal Regulations, Part 575 pursuant to the National Traffic and Motor Vehicle Safety Act of 1966.

Reporting safety defects

If you believe that your vehicle has a defect which could cause a crash or could cause injury or death, you should immediately inform the National Highway Traffic Safety

Administration (NHTSA) in addition to notifying Mercedes-Benz USA, LLC.

If NHTSA receives similar complaints, it may open an investigation, and if it finds that a safety defect exists in a group of vehicles, it may order a recall and remedy campaign. However, NHTSA cannot become involved in individual problems between you, your dealer, or Mercedes-Benz USA, LLC.

To contact NHTSA, you may call the Vehicle Safety Hotline toll-free at 1-888-327-4236 (TTY: 1-800-424-9153); go to: <http://www.safercar.gov>; or write to: Administrator, NHTSA Headquarters, 1200 New Jersey Avenue, SE, West Building, Washington, DC 20590.

You can also obtain additional information about vehicle safety from:

<http://www.safercar.gov>.

This information helps, for example, to test vehicle systems after an accident and to continually improve vehicle safety.

Daimler AG can access this data and submit it:

- for safety research or vehicle diagnosis purposes
- with the consent of the vehicle owner
- on the instruction of prosecuting authorities
- for use in arbitration of disputes that involve Daimler AG, its affiliates or its sales and service organizations
- as otherwise required or permitted by law.

Please observe the mbrace³ purchase agreement for further details on the recording and transfer of data by this system.

Limited Warranty

! Follow the instructions in this manual about the proper operation of your vehicle as well as about possible vehicle damage. Damage to your vehicle that arises from culpable contraventions against these instructions are not covered either by Mercedes-Benz Limited Warranty or by the New or Used-Vehicle Warranty of Daimler AG.

Data stored in the vehicle

Information about electronic data acquisition in the vehicle

(Including notice pursuant to California Code § 9951)

Your vehicle records electronic data. If your vehicle is equipped with mbrace³, data is transmitted in the event of an accident.

³ The system is called TELE AID in Canada.

Cockpit 28
Instrument cluster 29
Multifunction steering wheel 31
Center console 32
Overhead control panel 34
Door control panel 35



Cockpit

At a glance

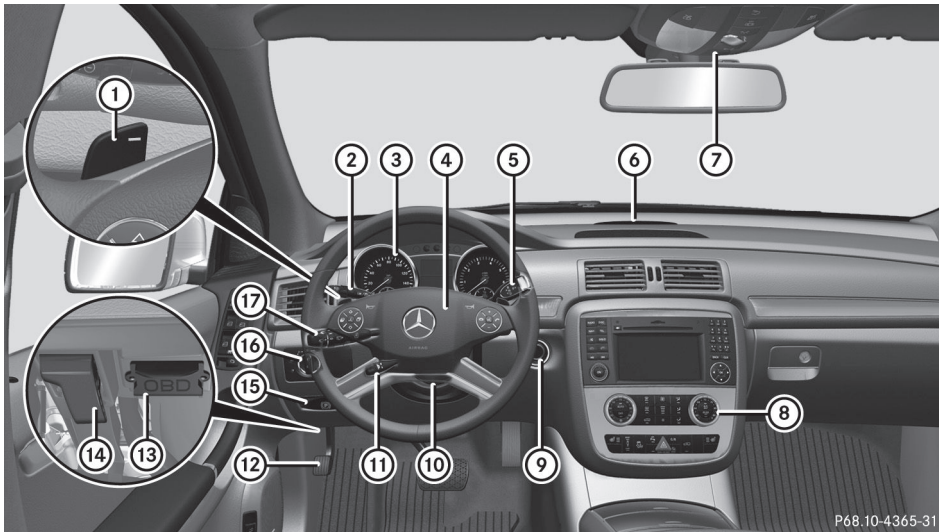

	Function	Page
①	Steering wheel paddle shifters	153
②	Cruise control lever	171
③	Instrument cluster	29
④	Horn	
⑤	DIRECT SELECT lever	150
⑥	PARKTRONIC warning display	184
⑦	Overhead control panel	34
⑧	Climate control systems	130
⑨	Ignition lock Start/Stop button	145 145

	Function	Page
⑩	Adjusts the steering wheel manually	107
⑪	Adjusts the steering wheel electrically Steering wheel heating	107 108
⑫	Parking brake	164
⑬	On-board diagnostics socket	
⑭	Opens the hood	282
⑮	Releases the parking brake	164
⑯	Light switch	114
⑰	Combination switch	117

Instrument cluster

Displays and controls

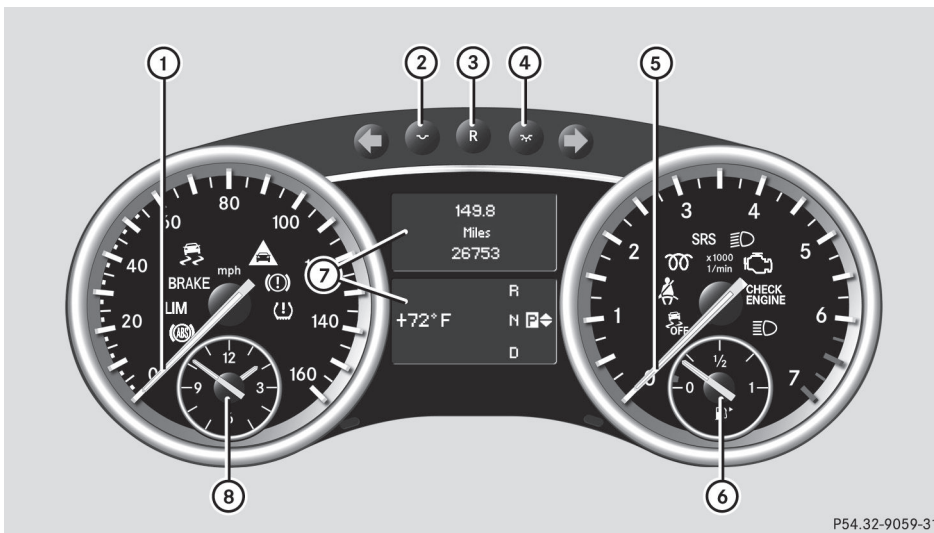

P54.32-9059-31

	Function	Page
①	Speedometer with segments	199
②	Adjusts the instrument cluster lighting: dimmer	
③	Reset button	
④	Adjusts the instrument cluster lighting: brighter	

	Function	Page
⑤	Tachometer	198
⑥	Fuel gauge	
⑦	Multifunction display	200
⑧	Clock	206

Warning and indicator lamps

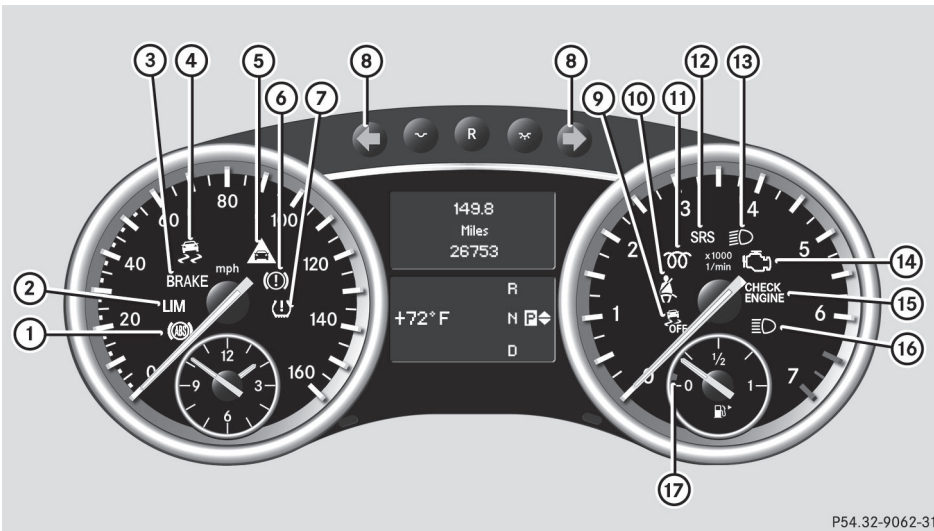

P54.32-9062-31





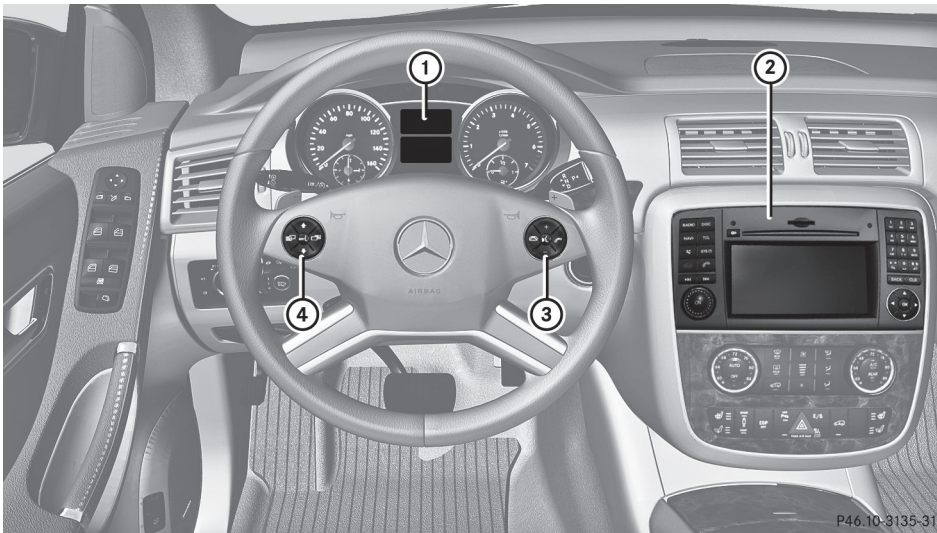

	Function	Page
①	ABS	240
②	The lamp lights up briefly, but has no function.	
③	Brakes (USA only)	239
④	ESP®	241
⑤	Distance warning signal On vehicles without DISTRONIC, the lamp lights up briefly but has no function.	245
⑥	Brakes (Canada only)	239
⑦	Tire pressure monitor (USA only)	245

	Function	Page
⑧	Turn signal	117
⑨	ESP® OFF	241
⑩	Seat belt	238
⑪	Diesel engine: preglow	146
⑫	SRS	243
⑬	Low-beam headlamps	115
⑭	Check Engine (Canada only)	244
⑮	Check Engine (USA only)	244
⑯	High-beam headlamps	117
⑰	Reserve fuel	244

Multifunction steering wheel

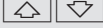

At a glance

	Function	Page		Function	Page
①	Multifunction display	200			
②	COMAND; see the separate operating instructions			Switches on the Voice Control System; see the separate operating instructions	
③	 Rejects or ends a call Exits phone book/redial memory  Makes or accepts a call Switches to the redial memory   Selects submenus in the Settings menu Changes values Adjusts the volume	211 205	④	 Selects a menu: scrolls back and forth  Switches off the Voice Control System; see the separate operating instructions  Scrolls back and forth within a menu	201 201





Center console

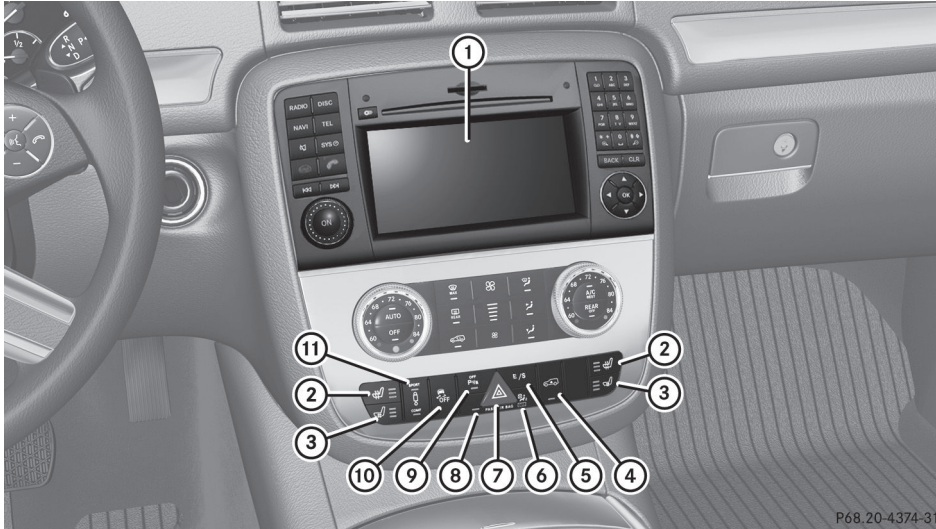



Center console, upper section

At a glance



P68.20-4374-31

	Function	Page
①	Audio system/COMAND; see the separate operating instructions	
②	 Seat heating	106
③	 Seat ventilation	106
④	 Level control	181
⑤	Selects the drive program	153
⑥	 PASS AIR BAG OFF Indicator lamp	44

	Function	Page
⑦	 Hazard warning lamps	117
⑧	ATA indicator lamp	69
⑨	 PARKTRONIC	184
⑩	 ESP®	66
⑪	 Adaptive Damping System	181

Center console, lower section

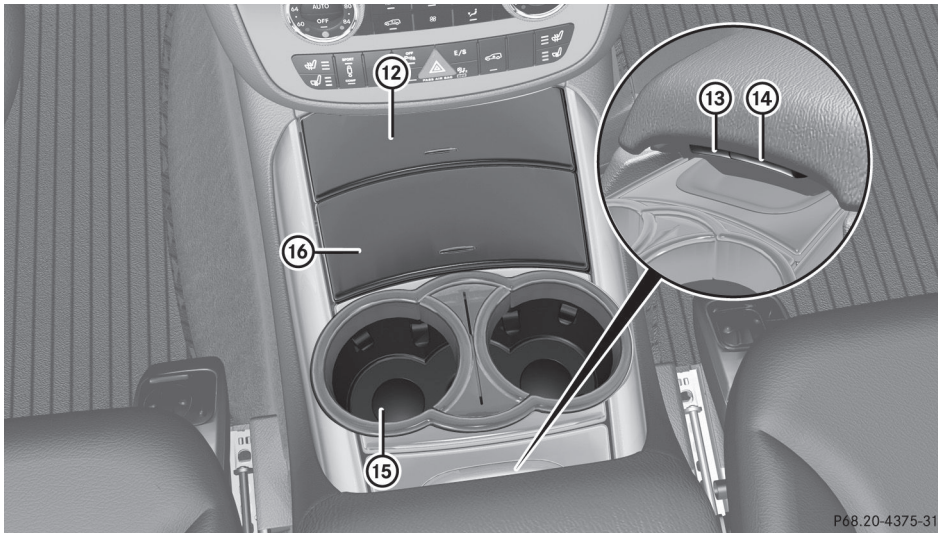

At a glance

	Function	Page		Function	Page
⑫	Stowage compartment	248	⑬	Stowage compartment	248
⑬	Stowage tray	248		Ashtray	265
⑭	Stowage compartment	248		Cigarette lighter	266
⑮	Cup holder	263			

Overhead control panel

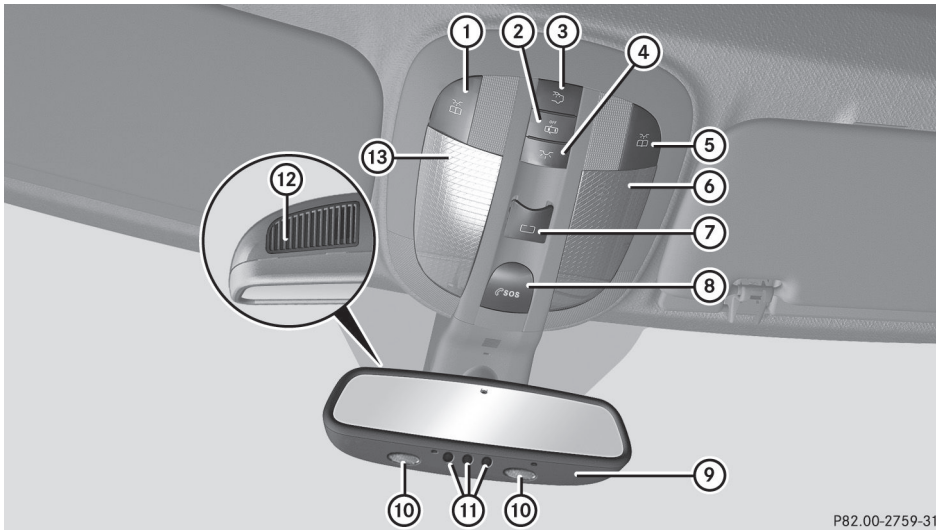

P82.00-2759-31







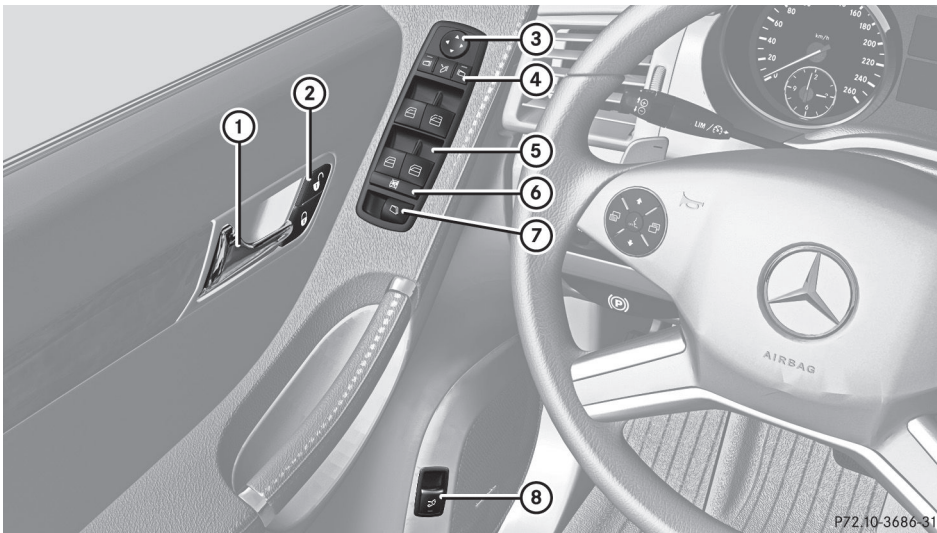



	Function	Page		Function	Page
①	Switches the left-hand reading lamp on/off	118	⑧	SOS button (mbrace system)	270
②	Switches the automatic interior lighting control on/off	119	⑨	Rear-view mirror	109
③	Switches the rear interior lighting on/off	119	⑩	Reading lamps	118
④	Switches the front interior lighting on/off	119	⑪	Buttons for the garage door opener	276
⑤	Switches the right-hand reading lamp on/off	118	⑫	Microphone for mbrace (emergency call system), telephone and the Voice Control System ⁴	
⑥	Interior lighting, right	119	⑬	Interior lighting, left	119
⑦	Opens/closes the sliding sunroof Opens/closes the panorama roof with power tilt/sliding panel and roller sunblinds	90 91			

⁴ Observe the additional operating instructions.

Door control panel



At a glance

	Function	Page
①	Opens the door	80
②	  Unlocks/locks the vehicle	80
③	 Adjusts the exterior mirrors	110
④	   Selects the exterior mirror, electrically folds the exterior mirrors in/out	110
⑤	 Opens/closes the side windows	86
⑥	 Activates/deactivates the override feature for the side windows in the rear compartment	63
⑦	 Opens/closes the hinged power side windows	87
⑧	 Opens/closes the tailgate	84

P72,10-3686-31

Useful information 38
Occupant safety 38
Children in the vehicle 56
Panic alarm 64
Driving safety systems 64
Theft deterrent locking systems 68

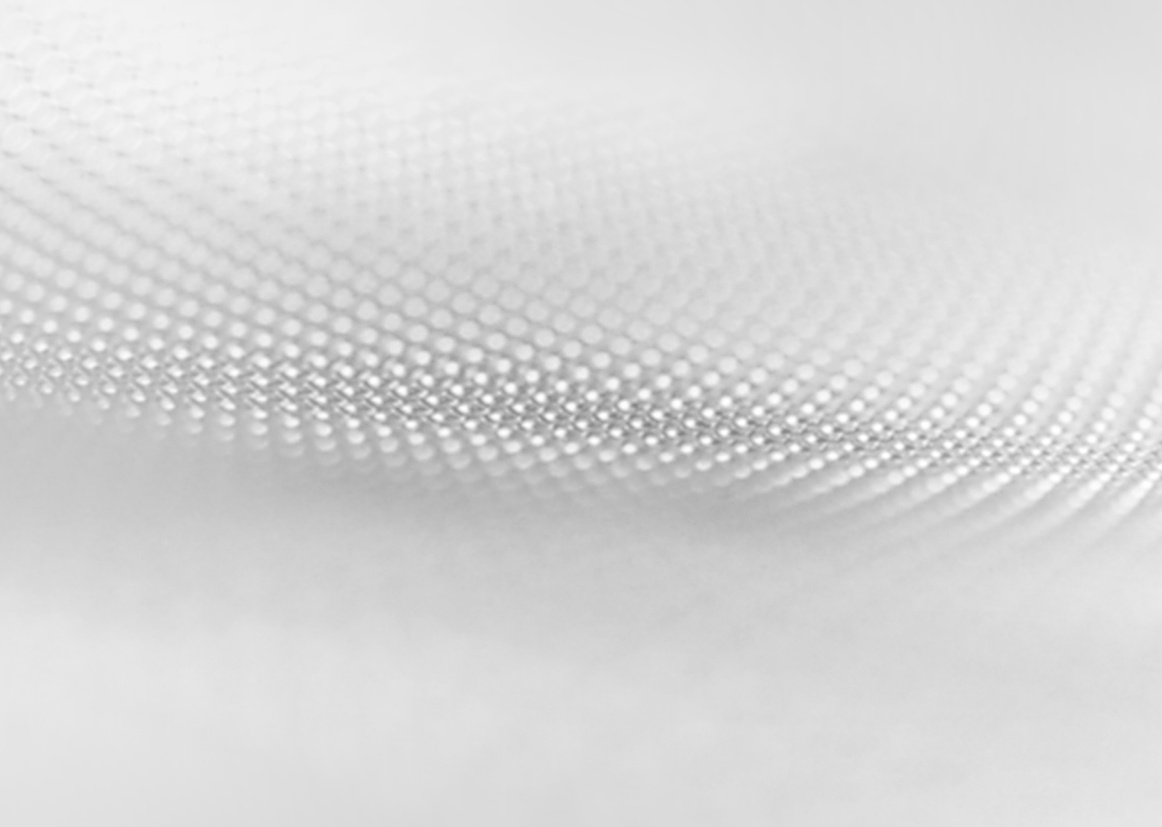

Useful information

- i** This Operator's Manual describes all models and all standard and optional equipment of your vehicle available at the time of publication of the Operator's Manual. Country-specific differences are possible. Please note that your vehicle may not be equipped with all features described. This also applies to safety-related systems and functions.
- i** Please read the information on qualified specialist workshops (▷ page 24).

Occupant safety

Overview of occupant safety

In this section, you will learn the most important facts about the restraint system components of the vehicle.

The restraint system consists of:

- seat belts
- child restraint systems
- LATCH-type (ISOFIX) child seat anchors

Additional protection is provided by:

- SRS (Supplemental Restraint System)
- NECK-PRO head restraints/NECK-PRO luxury head restraints
- PRE-SAFE®
- Air bag system components with:
 - PASSENGER AIR BAG OFF indicator lamp
 - front-passenger seat with Occupant Classification System (OCS)

The different air bag systems work independently of each other. The protective functions of the system work in conjunction with each other. Not all air bags are deployed in an accident.

WARNING

Modifications to or work improperly conducted on restraint system components or their wiring, as well as tampering with

interconnected electronic systems, can lead to the restraint systems no longer functioning as intended.

Air bags or Emergency Tensioning Devices (ETDs), for example, could deploy inadvertently or fail to deploy in accidents although the deceleration threshold for air bag deployment is exceeded. Therefore, never modify the restraint systems. Do not tamper with electronic components or their software.

- i** See "Children in the vehicle" (▷ page 56) for more information on infants and children traveling with you in the vehicle and restraints for infants and children.

SRS (Supplemental Restraint System)

Introduction

SRS consists of:

- the  SRS warning lamp
- air bags
- air bag control unit (with crash sensors)
- Emergency Tensioning Devices
- belt force limiters

SRS reduces the risk of occupants coming into contact with the vehicle's interior in the event of an accident. It can also reduce the effect of the forces to which occupants are subjected during an accident.

SRS warning lamps

SRS functions are checked regularly when you switch on the ignition and when the engine is running. Therefore, malfunctions can be detected in good time.

The  SRS warning lamp in the instrument cluster lights up when the ignition is switched on. It goes out no later than a few seconds after the engine is started.

The SRS components are in operational readiness when the **SRS** SRS warning lamp is not lit while the engine is running .

WARNING

The SRS self-check has detected a malfunction if the **SRS** SRS warning lamp:

- does not come on at all
- fails to go out approximately 4 seconds after the engine was started
- comes on after the engine was started or while driving

For your safety, Mercedes-Benz strongly recommends that you have the system checked as soon as possible at an authorized Mercedes-Benz Center. Otherwise the SRS may not be activated when it is needed in an accident, which could result in serious or fatal injury. The SRS might also deploy unexpectedly and unnecessarily which could also result in injury.

In addition, improper work on the SRS creates a risk of rendering the SRS inoperative or causing unintended air bag deployment. Work on the SRS must therefore only be performed by qualified technicians. Contact an authorized Mercedes-Benz Center.

If it is necessary to modify an air bag system to accommodate a person with disabilities, contact an authorized Mercedes-Benz Center for details. USA only: Call our Customer Assistance Center at 1-800-FOR-MERCEdes (1-800-367-6372) for details.

Safety guidelines for seat belts, Emergency Tensioning Devices (ETDs) and air bags

WARNING

- Damaged seat belts or seat belts that have been subjected to stress in an accident must be replaced. Their anchoring points must also be checked. Only use seat belts

installed or supplied by an authorized Mercedes-Benz Center.

- Air bags and pyrotechnic Emergency Tensioning Devices (ETDs) contain perchlorate material, which may require special handling and regard for the environment. Check your national disposal guidelines. California residents, see www.dtsc.ca.gov/HazardousWaste/Perchlorate/index.cfm.
- Air bags and ETDs are designed to function on a one-time-only basis. An air bag or ETD that has deployed must be replaced. PRE-SAFE® has electrically operated reversible belt tensioners in addition to the pyrotechnic ETDs.
- Do not pass seat belts over sharp edges. They could tear.
- Do not make any modification that could change the effectiveness of the seat belts.
- Do not bleach or dye seat belts as this may severely weaken them. In a crash they may not be able to provide adequate protection.
- No modifications of any kind may be made to any components or wiring of the SRS.
- Do not change or remove any component or part of the SRS.
- Do not install additional trim material, seat covers, badges, etc. to the:
 - padded steering wheel boss
 - front-passenger air bag cover
 - outer side of front seat bolsters
 - outer side of the seat bolsters of the rear bench seat backrest
 - roof lining trim
- Do not install additional electrical/ electronic equipment on or near SRS components and wiring.
- Keep area between air bags and occupants free of objects (e.g. packages, purses, umbrellas, etc.).
- Do not hang items such as coat hangers from the coat hooks or handles over the door. These items may be thrown around in

the vehicle and cause head and other injuries when the window curtain air bag is deployed.

- Air bag system components will be hot after an air bag has inflated. Do not touch them.
- Never place your feet on the instrument panel, dashboard, or on the seat. Always keep both feet on the floor in front of the seat.
- Improper repair work on the SRS creates a risk of rendering the SRS inoperative or causing unintended air bag deployment. Work on the SRS must therefore only be performed by qualified technicians. Contact an authorized Mercedes-Benz Center.
- For your protection and the protection of others, when scrapping the air bag unit or ETD, our safety instructions must be followed. These instructions are available from any authorized Mercedes-Benz Center.
- Given the considerable deployment speed, required inflation volume, and the material of the air bags, there is the possibility of abrasions or other, potentially more serious injuries resulting from air bag deployment.

If you sell your vehicle, Mercedes-Benz strongly recommends that you inform the subsequent owner that the vehicle is equipped with SRS. Also, refer them to the applicable section in the Operator's Manual.

Air bags

Important safety notes

WARNING

Air bags are designed to reduce the incidence of injuries and fatalities in certain situations:

- frontal impacts (driver's and front-passenger front air bags)
- side impacts (side impact air bags and window curtain air bags)
- rollover (window curtain air bags)

However, no system available today can completely eliminate injuries and fatalities.

When the air bags are deployed, a small amount of powder is released. The powder generally does not constitute a health hazard and does not indicate that there is a fire in the vehicle. In order to prevent potential breathing difficulties, you should leave the vehicle as soon as it is safe to do so. If you have any breathing difficulty but cannot get out of the vehicle after the air bag inflates, then get fresh air by opening a window or door.

WARNING

To reduce the risk of injuries during front air bag inflation, the driver and front-passenger must always be seated correctly and have their seat belts fastened accordingly.

For maximum protection in the event of a collision, you must always be in the normal seat position with your back against the backrest. Fasten your seat belt and make sure that it is correctly positioned on your body.

Since the air bag inflates with considerable speed and force, a proper seating position and correct positioning of the hands on the steering wheel will help to keep you at a safe distance from the air bag. Occupants who are not wearing their seat belt, are not seated properly or are too close to the air bag can be seriously injured or killed by an air bag as it inflates with great force instantaneously:

- Sit with the seat belt properly fastened in a position that is as upright as possible with your back against the seat backrest.
- Move the driver's seat as far back as possible, still permitting proper operation of vehicle controls. The distance from the center of the driver's chest to the center of the air bag cover on the steering wheel must be at least 10 inches (25 cm) or more. You should be able to accomplish this by adjusting the seat and steering wheel. If you have any difficulties, please contact an authorized Mercedes-Benz Center.
- Do not lean your head or chest close to the steering wheel or dashboard.
- Only hold the steering wheel by the rim. Placing hands and arms inside the rim can increase the risk and potential severity of hand/arm injury when the driver front air bag inflates.
- Adjust the front-passenger seat as far back as possible from the dashboard when the seat is occupied.
- Occupants, especially children, should never place their bodies or lean their heads in the area of the door where the side impact air bag inflates. This could result in serious injuries or death should the side impact air bag be deployed. Always sit as upright as possible, wear the seat belt properly and use an appropriately sized child restraint, infant restraint or booster seat recommended for the size and weight of the child.

Failure to follow these instructions can result in severe injuries to you or other occupants.

If you sell your vehicle, it is important that you make the buyer aware of this safety information. Be sure to give the buyer this Operator's Manual.

WARNING

Accident research shows that the safest place for children in an automobile is in a rear seat. A side impact air bag related injury may occur if occupants, especially children, are not properly seated or restrained when next to a side impact air bag which needs to deploy rapidly in a side impact in order to do its job. To help avoid the possibility of injury, please follow these guidelines:

- (1) Always sit as upright as possible and use the seat belts properly. Make sure that children 12 years old and under use an appropriately sized child restraint, infant restraint, or booster seat recommended for the size and weight of the child.
- (2) Always wear seat belts properly.

The air bags are only deployed if the air bag control unit detects the need for deployment. Only in the event of such a situation will they provide their supplemental protection.

The driver and passenger should always wear their seat belts. Otherwise, it is not possible for the air bags to provide their supplemental protection.

In the event of other types of impacts and impacts below air bag deployment thresholds, the air bags will not deploy. The driver and passengers will then be protected to the extent possible by a properly fastened seat belt. A properly fastened seat belt is also needed to provide the best possible protection in a rollover.

Air bags provide additional protection; they are not, however, a substitute for seat belts. All vehicle occupants must fasten their seat belts regardless of whether your vehicle is equipped with air bags or not.

It is important for your safety and that of your passenger to have deployed air bags replaced and to have any malfunctioning air bags repaired. This will help to make sure the air bags continue to perform their protective function for the vehicle occupants in the event of a crash.

Front air bags

The front air bags increase protection for the driver's and front-passenger's head and chest.

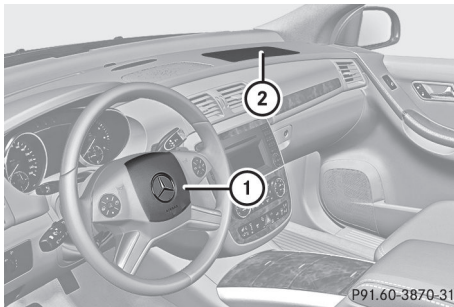

Driver's air bag ① deploys in front of the steering wheel; front-passenger front air bag ② deploys in front of and above the glove box.

They are deployed:

- in the event of certain frontal impacts
- if the system determines that air bag deployment can offer additional protection to that provided by the seat belt
- if the seat belt is fastened
- independently of other air bags in the vehicle

If the vehicle overturns, the front air bags are generally not deployed unless the system detects high vehicle deceleration in a longitudinal direction.

Your vehicle has adaptive, two-stage front air bags. In the event of a collision, the air bag control unit evaluates the vehicle deceleration. In the first deployment stage, the front air bag is filled with enough propellant gas to reduce the risk of injuries.

The front air bag is fully deployed if a second deployment threshold is exceeded within a few milliseconds.

The deployment of the front-passenger front air bag is also influenced by the weight category of the front passenger, which is determined by the Occupant Classification System (OCS) (> page 44).

The lighter the passenger side occupant, the higher the vehicle deceleration rate required (predicted at the start of the impact) for second stage inflation of the front-passenger front air bag. In the second stage, the front air bags are inflated with the maximum amount of propellant gas available.

The front air bags are not deployed in situations where a low impact severity is predicted. You will then be protected by the fastened seat belt.

The front-passenger front air bag will only deploy if:

- the system, based on the OCS weight sensor readings, detects that the front-passenger seat is occupied.
-
- the air bag control unit predicts a high impact severity.

Side impact air bags

WARNING

The pressure sensors for side impact air bag control are located in the doors. Do not modify any components of the doors or door trim panels including, for example, the addition of door speakers.

Improper repair work on the doors or the modification or addition of components to the doors create a risk of rendering the side impact air bags inoperative or causing unintended air bag deployment. Work on the doors must therefore only be performed by qualified technicians. Contact an authorized Mercedes-Benz Center.

⚠ WARNING

Only use seat covers which have been tested and approved by Mercedes-Benz for your vehicle model. Using other seat covers may interfere with or prevent the deployment of the side impact air bags. Contact an authorized Mercedes-Benz Center for availability.

When deployed, the side impact air bags offer additional protection for the thorax of the vehicle occupants on the side of the vehicle on which the impact occurs. However, they do not protect the:

- head
- neck
- arms

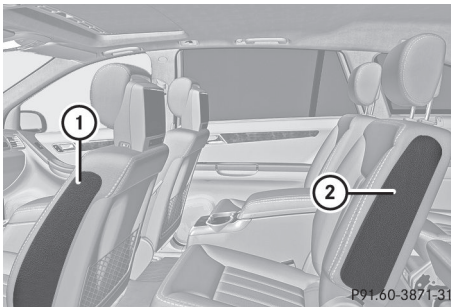

Front side impact air bags ① and rear side impact air bags ② deploy next to the outer seat cushions.

The side impact air bags are deployed:

- on the side on which an impact occurs
- at the start of an accident with a high rate of lateral vehicle deceleration or acceleration, e.g. in a side impact
- independently of seat belt use
- independently of the front air bags
- independently of the ETDs

If the vehicle overturns, the side impact air bags are generally not deployed. They are deployed if the system detects high vehicle deceleration or acceleration in a lateral direction and determines that side impact air

bag deployment can offer additional protection to that provided by the seat belt. Side impact air bags will not deploy in side impacts which do not exceed the system's preset deployment thresholds for lateral acceleration/deceleration. You will then be protected by the fastened seat belt.

If the OCS detects that the front-passenger seat is not occupied and the front-passenger seat belt is not fastened (the belt tongue is not engaged in the seat belt buckle), the side impact air bag on the front-passenger side will not deploy. The side impact air bag on the front-passenger side will deploy if the front-passenger seat belt is fastened, regardless of whether the front-passenger seat is occupied or not.

Window curtain air bags

The window curtain air bags enhance the level of protection for the head, but not chest or arms, of the vehicle occupants on the side of the vehicle on which the impact occurs.

The window curtain air bags are integrated into the side of the roof frame and deploy in the area extending from the front door (A-pillar) to the rear side window (D-pillar).

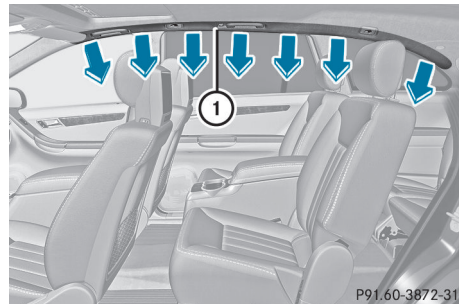

Window curtain air bags ① are deployed:



- on the side on which an impact occurs
- at the start of an accident with a high rate of lateral vehicle deceleration or acceleration, e.g. in a side impact
- regardless of whether the front-passenger seat is occupied

- independently of seat belt use
- if the vehicle overturns and the system determines that window curtain air bag deployment can offer additional protection to that provided by the seat belt
- independently of the front air bags

Window curtain air bags  will not deploy in impacts with deceleration rates which do not exceed the system's preset deployment thresholds for vehicle deceleration or acceleration. You will then be protected by the fastened seat belt.

Occupant Classification System (OCS)

How the occupant classification system works

The OCS categorizes the occupant on the front-passenger seat by means of a weight sensor. The front-passenger front air bag is deactivated automatically for certain weight categories. The  indicator lamp shows you the current status. If the  indicator lamp is illuminated, the front-passenger front air bag is deactivated.

The system does not disable:

- the side impact air bag
- the window curtain air bag
- the Emergency Tensioning Devices

To be classified correctly, the front passenger must sit:

- with the seat belt fastened correctly
- in a position that is as upright as possible with their back against the seat backrest
- with their feet on the floor

If the front-passenger's weight is transferred to another object in the vehicle (e.g. by leaning on armrests), OCS may not be able to approximate the occupant's weight category.

In addition, the occupant weight may appear to increase or decrease due to the following:

- objects hanging on the seat
- objects lodged underneath the seat
- objects lodged between the seat and the center console
- objects lodged between the seat and the door
- other passengers exerting weight on the seat
- objects applying pressure to the back of the seat



Make sure that the seat always has clearance in all directions.

If the front-passenger seat, the seat cover or the seat cushion are damaged, have the necessary repair work carried out at an authorized Mercedes-Benz Center.

For safety reasons, Mercedes-Benz recommends that you only use seat accessories which have been approved by Mercedes-Benz.

Both the driver and the passenger should always use the  indicator lamp as an indication of whether or not the passenger is properly positioned.

WARNING

If the  indicator lamp illuminates when an adult or someone larger than a small individual is in the front passenger seat, have the front passenger reposition himself or herself in the seat until the  indicator lamp goes out, or check whether objects are caught under or around the seat.

In the event of a collision, the air bag control unit will not allow front passenger front air bag deployment when the OCS has classified the front passenger seat occupant as weighing as much as or less than a typical 12-month-old child in a standard child restraint or if the front passenger seat is classified as being empty.



When the OCS senses that the front passenger seat occupant is classified as

being up to or less than the weight of a typical 12-month-old child in a standard child restraint, the  indicator lamp will illuminate when the engine is started and remain illuminated. This indicates that the front passenger front air bag is deactivated.

When the OCS senses that the front passenger seat is classified as being empty, the  indicator lamp will illuminate when the engine is started and remain illuminated. This indicates that the front passenger front air bag is deactivated.

When the OCS senses that the front passenger seat occupant is classified as being heavier than the weight of a typical 12-month-old child seated in a standard child restraint or as being a small individual (such as a young teenager or a small adult), the

 indicator lamp will illuminate for approximately 6 seconds when the engine is started. Depending on occupant weight sensor readings from the seat, it will then remain illuminated or go out. With the

 indicator lamp illuminated, the front passenger front air bag is deactivated. With the  indicator lamp out, the front passenger front air bag is activated.

When the OCS senses that the front passenger seat occupant is classified as an adult or someone larger than a small individual, the  indicator lamp will illuminate for approximately six seconds when the engine is started and then go out. This indicates that the front passenger front air bag is activated.

If the  indicator lamp is illuminated, the front passenger front air bag is deactivated and will not be deployed.

If the  indicator lamp is not illuminated, the front passenger front air bag is activated and will be deployed

- in the event of certain frontal impacts
- if the impact exceeds a predetermined triggering threshold
- independently of the side impact air bags

If the front passenger front air bag is deployed, the rate of inflation will be influenced by

- the rate of vehicle deceleration as assessed by the air bag control unit
- the front passenger's weight category as identified by the OCS

For further information, see "air bag display messages" (> page 220).





WARNING

According to accident statistics, children are safer when properly restrained on the rear seats than on the front-passenger seat. Thus, we strongly recommend that children be placed in the rear seats whenever possible. Regardless of seating position, children 12 years old and under must be seated and properly secured in an appropriately sized child restraint system or booster seat recommended for the size and weight of the child.

The infant or child restraint system must be properly secured with the vehicle's seat belt, the seat belt and Top Tether strap, or lower anchors and Top Tether strap, fully in accordance with the child seat manufacturer's instructions.

Occupants, especially children, should always sit as upright as possible, wear the seat belt properly and use an appropriate sized infant restraint, toddler restraint, or booster seat recommended for the size and weight of the child.

Children can be killed or seriously injured by an inflating air bag. Note the following important information when circumstances require you to place a child in the front-passenger seat:

- Your vehicle is equipped with air bag technology designed to deactivate the front-passenger front air bag in your vehicle when the system senses the weight of a typical 12-month-old child or less along with the weight of a standard appropriate child restraint on the front-passenger seat.
- A child in a rear-facing child restraint on the front-passenger seat will be seriously injured or even killed if the front-passenger front air bag inflates in a collision which could occur under some circumstances, even with the air bag technology installed in your vehicle. The only means to eliminate this risk completely is never to place a child in a rear-facing child restraint in the front-passenger seat. We therefore strongly recommend that you always place a child in a rear-facing child restraint on the rear seat.
- If you install a rear-facing child restraint on the front-passenger seat, make sure the  **PASS AIR BAG OFF** indicator lamp is illuminated, indicating that the front-passenger front air bag is deactivated. Should the  **PASS AIR BAG OFF** indicator lamp not illuminate or go out while the restraint is installed, please check installation. Periodically check the  **PASS AIR BAG OFF** indicator lamp while driving to make sure the  **PASS AIR BAG OFF** indicator lamp is illuminated. If the  **PASS AIR BAG OFF** indicator lamp goes out or remains out, do not transport a child on the front-passenger seat until the system has been repaired. A child in a rear-facing child restraint on the front-passenger seat will be seriously injured or even killed if the front-passenger front air bag inflates.

- If you place a child in a forward-facing child restraint on the front-passenger seat:
 - move the seat as far back as possible
 - use the proper child restraint recommended for the age, size and weight of the child
 - secure child restraint with the vehicle's seat belt according to the child seat manufacturer's instructions
- For children larger than a typical 12-month-old child, the front-passenger front air bag can be activated or deactivated.

If the driver's air bag deploys, this does not mean that the front-passenger front air bag also has to deploy.

The OCS may have detected that the seat:

- was empty or occupied by a person with a weight of up to or less than that of a typical 12-month-old child seated in a standard child restraint
- was occupied by a small individual, such as a young teenager or a small adult
- was occupied by a child in a child restraint system, whose weight is greater than that of a typical 12-month-old child.

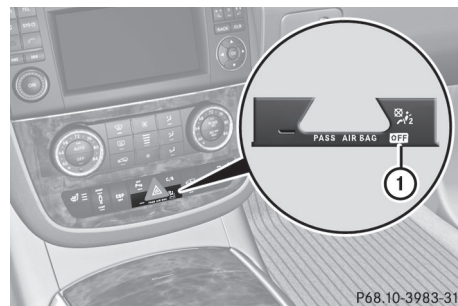

These are examples of when the OCS deactivates the front-passenger front air bag. Deactivation takes place although the collision fulfills the criteria for deploying the driver's air bag.



If the SmartKey has been removed from the ignition lock or is in position **0**, indicator lamp

 **PASS AIR BAG OFF** ① does not light up.

⚠ WARNING

If the red  SRS warning lamp in the instrument cluster and the  indicator lamp light up simultaneously, the OCS is malfunctioning. The front passenger front air bag will be deactivated in this case. Have the system checked by qualified technicians as soon as possible. Contact an authorized Mercedes-Benz Center.

Only have the seat repaired or replaced at an authorized Mercedes-Benz Center.

In order to ensure proper operation of the air bag system and OCS:

- Do not place more than 4.4 lb (2 kg) into the parcel net on the rear of the front passenger seat. Otherwise, the OCS may not be able to properly approximate the occupant weight category.
- Do not place objects under and/or around the front passenger seat.
- Do not hang anything from or attach any items to the seats.
- do not store any objects, such as books, between the front passenger seat and the center console or the front-passenger door.
- Do not move the front passenger seat backwards against rigid objects.
- Sit with the seat belt properly fastened in a position that is as upright as possible with your back against the seat backrest.
- When seated, a passenger should not position him/herself in such a way as to cause the passenger's weight to be lifted from the seat cushion as this may result in the OCS being unable to correctly approximate the passenger's weight category.
- Read and observe all warnings in this chapter.

System self-test

The  indicator lamp illuminates when you:

- turn the SmartKey to position **1** or **2** in the ignition lock
- press the KEYLESS-GO Start/Stop button once or twice

If an adult occupant is properly sitting on the passenger seat and the OCS classifies the occupant as an adult, the  indicator lamp illuminates and goes out again after approximately 6 seconds.

If the seat is not occupied and the OCS classifies the front passenger seat as being unoccupied, the  indicator lamp will illuminate and not go out.

⚠ WARNING

If the  indicator lamp does not illuminate, the system is not functioning. You must contact an authorized Mercedes-Benz Center before seating any child on the front passenger seat.

For more information, see "Problems with the Occupant Classification System" (> page 48).

⚠ WARNING

Never place anything between seat cushion and child seat (e.g. a pillow), since it reduces the effectiveness of the OCS. The underside and rear side child restraint system must be placed entirely on the seat cushion and the backrest of the front-passenger seat backrest.

If necessary, adjust the tilt of the passenger seat backrest.



An incorrectly mounted child seat could cause injuries to the child in case of an accident, instead of increasing protection for the child. Follow the manufacturer's instructions for installation of child restraint systems.

Problems with the occupant classification system

Problem	Possible causes/consequences and ► Solutions
<p>The  PASS AIR BAG OFF indicator lamp illuminates and remains illuminated. The person on the front-passenger seat:</p> <ul style="list-style-type: none"> • has the weight of a typical adult • has been determined by the system not to be a child. 	<p>The OCS is malfunctioning.</p> <ul style="list-style-type: none"> ► Have the OCS checked as soon as possible at an authorized Mercedes-Benz Center. ► Observe the additional display messages in the multifunction display (► page 220).

WARNING

If the  **PASS AIR BAG OFF** indicator lamp illuminates and remains illuminated when the weight of a typical adult or someone larger than a small individual has been detected on the passenger seat, the system then determines the occupant cannot be a child. Do not allow any occupant to use the passenger seat until the system has been repaired.

Problem	Possible causes/consequences and ► Solutions
<p>The  PASS AIR BAG OFF indicator lamp does not illuminate and/or does not remain illuminated. The front-passenger seat is:</p> <ul style="list-style-type: none"> • unoccupied • occupied with a weight up to or less than a typical 12-month-old child in a standard child restraint system 	<p>The OCS is malfunctioning.</p> <ul style="list-style-type: none"> ► Make sure there is nothing between the seat cushion and the child seat. ► Check the installation of the child restraint system. ► Make sure that no objects are applying additional weight onto the seat. ► Make sure there are no objects applying additional force to the seat. Head restraints that press against the roof or books that are behind or trapped between the seat, for example, apply additional force to the seat. The OCS senses such forces as additional weight. ► If the  PASS AIR BAG OFF indicator lamp does not illuminate, have the OCS checked as soon as possible at an authorized Mercedes-Benz Center. Do not transport a child on the front-passenger seat as long as the OCS is not functioning. ► Observe the additional display messages in the multifunction display (► page 220).

⚠ WARNING

If the  **PASS AIR BAG OFF** indicator lamp does not illuminate or remains out with the weight of a typical 12-month-old child in a standard child restraint or less, or is unoccupied, on the front-passenger seat, do not transport a child on the front-passenger seat until the system has been repaired.

PRE-SAFE® (preventative occupant protection)**⚠ WARNING**

The PRE-SAFE® system reduces the impact of an accident on vehicle occupants, as long as their seat belts have been fastened correctly. Although your vehicle is equipped with a PRE-SAFE® system, the possibility of injury in the event of an accident cannot be ruled out. You should therefore always drive carefully and adapt your driving style to the prevailing road, weather and traffic conditions.

PRE-SAFE® takes preemptive measures to protect occupants in certain hazardous situations.

PRE-SAFE® intervenes:

- in emergency braking situations when BAS intervenes
- in critical driving situations, e.g. when physical limits are exceeded and the vehicle understeers or oversteers severely

PRE-SAFE® takes the following measures depending on the hazardous situation detected:

- the front seat belts are pre-tensioned.
- on vehicles with memory function for the front-passenger seat: the front-passenger seat is adjusted if it is in an unfavorable position.
- if the vehicle skids, the side windows are closed so that only a small gap remains.
- on vehicles with a sliding sunroof: if the vehicle skids, the sliding sunroof closes so that only a small gap remains.

If the hazardous situation passes without resulting in an accident, PRE-SAFE® slackens

the belt pretensioning. All settings made by PRE-SAFE® can then be reversed.

If the seat belts are not released:

- ▶ Move the backrest or seat back slightly, but only when the vehicle is stationary. The belt pretensioning is reduced and the locking mechanism is released.

⚠ WARNING

Make sure that nobody can become trapped as you adjust the seat.

- ❗ Make sure that there are no objects in the footwell or behind the seats when resetting the seats. There is a risk that the seats and/or the objects could be damaged.

More information about seat-belt adjustment, a convenience function integrated into PRE-SAFE®, can be found in the "Seat-belt adjustment" section (> page 54).

NECK-PRO head restraints/NECK-PRO luxury head restraints

NECK-PRO head restraints/NECK-PRO luxury head restraints increase protection of the driver's and front-passenger's head and neck. In the event of a rear collision of a certain severity, the NECK-PRO head restraints/NECK-PRO luxury head restraints on the driver's and front-passenger seats are moved forwards and upwards. This provides better head support.

⚠ WARNING

Do not attach any objects (e.g. a coat hanger) to the NECK-PRO head restraints/NECK-PRO luxury head restraints. Otherwise, the NECK-

PRO head restraints/NECK-PRO luxury head restraints may not function properly and in the event of a rear-end collision may not offer the protection they are designed to provide.

WARNING

Seat or head restraint covers can cause a malfunction when the NECK-PRO head restraints/NECK PRO luxury head restraints are activated or when the side impact air bags are deployed, or they can prevent this completely. The NECK-PRO head restraints/NECK PRO luxury head restraints or side impact air bags can therefore not provide the intended protection. Do not use any seat or head restraint covers.

If the NECK-PRO head restraints/NECK-PRO luxury head restraints have been triggered in an accident, reset the NECK-PRO head restraints/NECK-PRO luxury head restraints on the driver's and front-passenger seats (► page 50). Otherwise, the additional protection will not be available in the event of another rear-end collision. NECK-PRO head restraints/NECK-PRO luxury head restraints that have been triggered are moved forwards and can no longer be adjusted.

WARNING

For your protection, drive only with properly positioned head restraints.

Adjust the head restraint so that it is as close to the head as possible and the center of the head restraint supports the back of the head at eye level. This will reduce the potential for injury to the head and neck in the event of an accident or similar situation.

Resetting triggered NECK-PRO head restraints

Important safety notes

WARNING

For reasons of safety, have the NECK-PRO head restraints/NECK-PRO luxury head

restraints checked at an authorized Mercedes-Benz Center after a rear-end collision.

WARNING

When pushing back the NECK-PRO head restraint cushion, make sure your fingers do not become caught between the head restraint cushion and the cover. Failure to observe this could result in injuries.

NECK-PRO head restraints

- i** Resetting the NECK-PRO head restraints requires a lot of strength. If you have difficulty resetting the NECK-PRO head restraints, have this work carried out at a qualified specialist workshop, e.g. an authorized Mercedes-Benz Center.

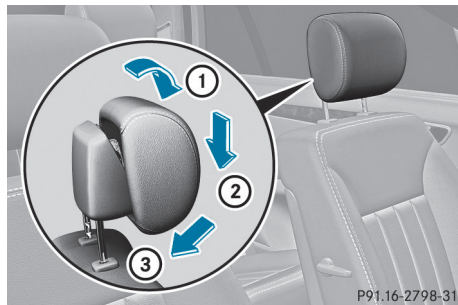

- ▶ Tilt the top of the NECK-PRO head restraint cushion forwards in the direction of arrow ①.
- ▶ Push the NECK-PRO head restraint cushion down in the direction of arrow ② as far as it will go.
- ▶ Firmly push the NECK-PRO head restraint cushion back in the direction of arrow ③ until the cushion engages.
- ▶ Repeat this procedure for the second NECK-PRO head restraint.

NECK-PRO luxury head restraints

- i** If you have difficulty resetting the NECK-PRO luxury head restraints, have this work carried out at a qualified specialist

workshop, e.g. an authorized Mercedes-Benz Center.

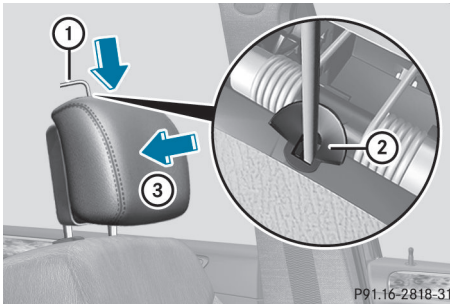

- ▶ Remove resetting tool ① from the vehicle document wallet.
- ▶ Slide resetting tool ① into guide ② between the NECK-PRO luxury head restraint and the rear cover of the head restraint.
- ▶ Push resetting tool ① downwards until you hear the head restraint deployment mechanism engage.
- ▶ Pull out resetting tool ①.
- ▶ Firmly press the NECK-PRO luxury head restraint cushion back ③ until it engages.
- ▶ Repeat this procedure for the second NECK-PRO luxury head restraint.
- ▶ Put resetting tool ① back into the vehicle document wallet.

Seat belts

Important safety notes

The use of seat belts and infant and child restraint systems is required by law in all 50 states, the District of Columbia, the U.S. territories and all Canadian provinces.

Even where this is not the case, all vehicle occupants should have their seat belts fastened when the vehicle is in motion.

- ❗ For further information on infants and children traveling in the vehicle and on infant and child restraint systems, see "Children in the vehicle" (▷ page 56).

⚠ WARNING

Always fasten your seat belt before driving off. Always make sure all of your passengers are properly restrained. You and your passengers should always wear seat belts.

Failure to wear and properly fasten and position your seat belt greatly increases your risk of injuries and their likely severity in an accident.

If you are ever in an accident, your injuries can be considerably more severe without your seat belt properly buckled. Without your seat belt buckled, you are much more likely to hit the interior of the vehicle or be ejected from it. You can be seriously injured or killed.

In the same crash, the possibility of injury or death is lessened if you are properly wearing your seat belt. The air bags can only protect as intended if the occupants are properly wearing their seat belts.

⚠ WARNING

Never ride in a moving vehicle with the seat backrest in an excessively reclined position as this can be dangerous. You could slide under the seat belt in a collision. If you slide under it, the seat belt would apply force at the abdomen or neck. That could cause serious or even fatal injuries. The seat backrest and seat belt provide the best restraint when the wearer is in a position that is as upright as possible and the seat belt is properly positioned on the body.

⚠ WARNING

Never let more people ride in the vehicle than there are seat belts available. Make sure everyone riding in the vehicle is correctly restrained with a separate seat belt. Never use a seat belt for more than one person at a time.

⚠ WARNING

Damaged seat belts or seat belts that have been subjected to stress in an accident must

be replaced and their anchoring points must also be checked.

Only use seat belts which have been approved by Mercedes-Benz.

Do not make any modifications to the seat belts. This can lead to unintended activation of the ETDs or to their failure to activate when necessary.

Do not bleach or dye seat belts as this may severely weaken them. In a crash they may not be able to provide adequate protection.

Have all work carried out only by qualified technicians. Contact an authorized Mercedes-Benz Center.

Correct use of the seat belts

WARNING

USE SEAT BELTS PROPERLY

- Seat belts can only work when used properly. Never wear seat belts in any other way than as described in this section, as that could result in serious injuries in the event of an accident.
- Each occupant should wear their seat belt at all times, because seat belts help reduce the likelihood of and potential severity of injuries in accidents, including rollovers. The integrated restraint system includes SRS (driver front air bag, front-passenger front air bag, side impact air bags, window curtain air bags for the side windows), Emergency Tensioning Devices, seat belt force limiters, and front seat knee bolsters. The system is designed to enhance the protection offered to properly belted occupants in certain frontal (front air bags and ETDs) and side (side impact air bags, window curtain air bags, and ETDs) impacts which exceed preset deployment thresholds and in certain rollovers (window curtain air bags and ETDs).
- Never wear the shoulder belt under your arm, across your neck or off your shoulder. In a frontal crash, your body would move too far forward. That would increase the chance of head and neck injuries. The seat belt would also apply too much force to the ribs or abdomen, which could severely injure internal organs such as your liver or spleen.
- Adjust the seat belt so that the shoulder section is located as close as possible to the middle of the shoulder. It should not touch the neck. Never pass the shoulder portion of the seat belt under your arm. For this purpose, you can adjust the height of the seat belt outlet.
- Position the lap belt as low as possible on your hips and not across the abdomen. If the lap belt is positioned across your abdomen, it could cause serious injuries in a crash.
- Never wear seat belts over rigid or breakable objects in or on your clothing, such as eyeglasses, pens, keys etc., as these might cause injuries.
- Make sure the seat belt is always routed snugly. Take special care of this when wearing loose clothing.
- Never use a seat belt for more than one person at a time. Do not fasten a seat belt around a person and another person or other objects at the same time.
- Seat belts should not be worn twisted. In a crash, you would not have the full width of the seat belt to distribute impact forces. The twisted seat belt against your body could cause injuries.
- Pregnant women should also always use a lap-shoulder belt. The lap belt portion should be positioned as low as possible on the hips to avoid any possible pressure on the abdomen.
- Place the seat backrest in a position that is as upright as possible.
- Check your seat belt during travel to make sure it is properly positioned.
- Never place your feet on the instrument panel, dashboard, or on the seat. Always

keep both feet on the floor in front of the seat.

- When using a seat belt to secure infant restraints, toddler restraints, or children in booster seats, always follow the child seat manufacturer's instructions.

WARNING

Do not pass seat belts over sharp edges. They could tear.

Do not allow the seat belt to get caught in the door or in the seat adjustment mechanism. This could damage the seat belt.

Never attempt to make modifications to seat belts. This could impair the effectiveness of the seat belts.

Fastening seat belts

WARNING

According to accident statistics, children are safer when properly restrained on the rear seats than on the front-passenger seat. Thus, we strongly recommend that children be placed in the rear seat whenever possible. Regardless of seating position, children 12 years old and under must be seated and properly secured in an appropriately sized child restraint system or booster seat recommended for the size and weight of the child. For additional information, see the "Children in the vehicle" section.

A child's risk of serious or fatal injuries is significantly increased if the child restraints are not properly secured in the vehicle and/or the child is not properly secured in the child restraint.



- ▶ Adjust the seat and move the backrest to an almost vertical position (▷ page 96).
- ▶ Pull the seat belt smoothly through belt sash guide ①.
- ▶ Without twisting it, guide the shoulder section of the seat belt across the middle of your shoulder and the lap section across your hips.
- ▶ Engage belt tongue ② in buckle ③. Seat-belt adjustment: if necessary, the driver's and front-passenger seat belts automatically adjust to the upper body (▷ page 54).
- ▶ If necessary, adjust the seat belt to the appropriate height (▷ page 54).
- ▶ If necessary, pull upwards on the shoulder section of the seat belt to tighten the belt across your body.

All seat belts except the driver's seat belt are equipped with a special seat belt retractor to securely fasten child restraint systems in the vehicle. For further information on special seat belt retractors, see (▷ page 58).

For more information about releasing the seat belt with release button ④, see "Releasing seat belts" (▷ page 54).

Seat belt adjustment

The seat-belt adjustment function adjusts the driver's and front-passenger seat belt to the upper body of the occupants.

The belt strap is tightened slightly when:

- you engage the belt tongue in the belt buckle and you then turn the SmartKey to position **2** in the ignition lock.
- the SmartKey is in position **2** in the ignition lock and you then engage the belt tongue in the buckle.

The seat-belt adjustment will apply a retraction force if any slack is detected between the occupant and the seat belt. Do not hold on to the seat belt tightly while it is adjusting. You can switch the seat-belt adjustment on and off in the on-board computer (▷ page 209).

The seat-belt adjustment is an integral part of the PRE-SAFE® convenience function. More information about PRE-SAFE® can be found in the "PRE-SAFE® (preventative occupant protection)" section (▷ page 49).

Belt height adjustment

You can adjust the seat belt height on the driver's seat and the front-passenger seat.

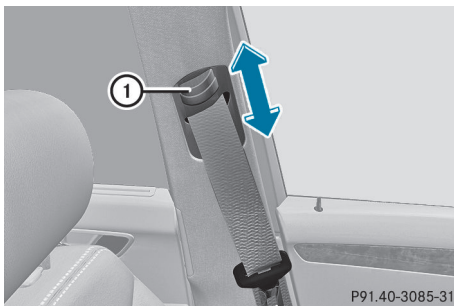

Adjust the height so that the upper part of the seat belt is routed across the center of your shoulder.

- ▶ **To raise:** slide the belt sash guide upwards. The belt sash guide engages in various positions.
- ▶ **To lower:** press and hold belt sash guide release ①.
- ▶ Slide the belt sash guide downwards.
- ▶ Release belt sash guide release ① and make sure that the belt sash guide has engaged.

Releasing seat belts

- ▶ Press release button ④ (▷ page 53) and guide belt tongue ② back towards belt sash guide ①.

! Make sure that the seat belt is fully rolled up. Otherwise, the seat belt or belt tongue will be trapped in the door or in the seat mechanism. This could damage the door, the door trim panel and the seat belt. Damaged seat belts can no longer fulfill their protective function and must be replaced. Consult an authorized Mercedes-Benz Center.

Belt warning for the driver and front passenger

Regardless of whether the driver and front passenger have fastened their seat belts already, the  seat belt warning lamp lights up for 6 seconds after every engine start. It then goes out if the driver and the front passenger have fastened their seat belts.

If the driver's seat belt is not fastened after the engine is started, an additional warning tone will sound. The warning tone goes out after approximately six seconds or once the driver's seat belt is fastened.

If the driver or front passenger have not fastened their seat belt after 6 seconds and the doors are closed, the  seat belt warning lamp lights up.

- until the driver or the front passenger have fastened their seat belts
- if a vehicle speed of 15 mph(25 km/h) is exceeded once, a warning tone with increasing intensity sounds additionally for a maximum of 60 seconds or until the driver or front passenger have fastened their seat belts.

If the driver or front passenger undo their seat belts during the journey, the  seat belt warning lamp lights up and the warning tone sounds again.

The warning tone ceases even if the driver or front passenger have still not fastened their seat belt after 60 seconds. The  seat belt warning lamp stops flashing but continues to be lit.

Once the vehicle is stationary, the warning tone is reactivated and the  seat belt warning lamp starts to flash again if the vehicle speed exceeds 15 mph(25 km/h) once.

The  seat belt warning lamp only goes out if:

- both the driver and the front passenger have fastened their seat belts.
- or
- the vehicle is stationary and a door is open.

i For more information on the  seat belt warning lamp, see "Warning and indicator lamps in the instrument cluster, seat belt" (▷ page 238).

Emergency Tensioning Devices, seat belt force limiters

The seat belts for the following seats are equipped with ETDs and seat belt force limiters:

- driver's and front-passenger seat
- the outer seats in the second row
- the seats in the third row

The ETDs tighten the seat belts in an accident, pulling them close against the body.

The ETDs do not correct incorrect seat positions or incorrectly fastened seat belts.

The ETDs do not pull vehicle occupants back towards the backrest.

Seat belt force limiters, when triggered, help to reduce the peak force exerted by the seat belt on the vehicle occupant.

The seat belt force limiters for the front seats are synchronized with the front air bags.

These take on a part of the deceleration force. Thus, the force exerted on the occupant is distributed over a greater area.

The ETDs can only be activated when:

- the ignition is switched on.
- the restraint systems are operational; see "SRS warning lamp" (▷ page 38)
- the belt tongue is engaged in the buckle on each of the lap-shoulder belts in the front.
- the front-passenger seat is occupied and the belt tongue is engaged in the buckle on the front-passenger side.

The ETDs on the outside seats in the second row and on the seats in the third row are triggered independently of the lock status of the seat belts.

The ETDs are triggered depending on the type and severity of an accident:

- if, in the event of a head-on or rear-end collision, the vehicle decelerates or accelerates rapidly in a longitudinal

direction during the initial stages of the impact

- if, in the event of a side impact, the vehicle is subjected to high lateral acceleration/ deceleration
- if in certain situations where the vehicle overturns and the system determines that it can provide additional protection

If the air bags are deployed, you will hear a bang, and a small amount of powder may also be released. Only in rare cases will the bang affect your hearing. The powder that is released generally does not constitute a health hazard. The  SRS warning lamp lights up.

WARNING

Pyrotechnic Emergency Tensioning Devices that have been deployed must be renewed.

For your safety, when disposing of Emergency Tensioning Devices, always observe the safety instructions. These are available from any authorized Mercedes-Benz Center.

The PRE-SAFE® system has electrically operated reversible pre-tensioners that do not require replacement after activation.

- ❗ If the front-passenger seat is not occupied, do not engage the seat belt tongue in the buckle on the front-passenger seat. Otherwise, the Emergency Tensioning Device could be triggered in the event of an accident.

Children in the vehicle

Child restraint systems

Important safety notes

We recommend that all infants and children be properly secured in an infant or child restraint system at all times while the vehicle is in motion.

The use of seat belts and infant and child restraint systems is required by law in all 50

states, the District of Columbia, the U.S. territories and all Canadian provinces.

Infants and children must always be seated in an appropriate infant or child restraint system recommended for the size and weight of the child. The infant or child restraint system must be properly secured in accordance with the manufacturer's instructions. All infant or child restraint systems must meet U.S. Federal Motor Vehicle Safety Standards 213 and 225 and Canadian Motor Vehicle Safety Standards 213 and 210.2.

An information label on the child restraint system indicates whether it meets these standards. This information is also provided in the installation instructions supplied with the child restraint system.

Always read and follow the manufacturer's instructions when using an infant or child restraint system or booster seat.

Observe all warning signs in the vehicle interior and on the infant or child restraint.





WARNING

According to accident statistics, children are safer when properly restrained on the rear seats than on the front-passenger seat. Thus, we strongly recommend that children be placed in the rear seats whenever possible. Regardless of seating position, children 12 years old and under must be seated and properly secured in an appropriately sized child restraint system or booster seat recommended for the size and weight of the child.

The infant or child restraint system must be properly secured with the vehicle's seat belt, the seat belt and Top Tether strap, or lower anchors and Top Tether strap, fully in accordance with the child seat manufacturer's instructions.

Occupants, especially children, should always sit as upright as possible, wear the seat belt properly and use an appropriate sized infant restraint, toddler restraint, or booster seat recommended for the size and weight of the child.

Children can be killed or seriously injured by an inflating air bag. Note the following important information when circumstances require you to place a child in the front-passenger seat:

- Your vehicle is equipped with air bag technology designed to deactivate the front-passenger front air bag in your vehicle when the system senses the weight of a typical 12-month-old child or less along with the weight of a standard appropriate child restraint on the front-passenger seat.
- A child in a rear-facing child restraint on the front-passenger seat will be seriously injured or even killed if the front-passenger front air bag inflates in a collision which could occur under some circumstances, even with the air bag technology installed in your vehicle. The only means to eliminate this risk completely is never to place a child in a rear-facing child restraint in the front-passenger seat. We therefore strongly recommend that you always place a child in a rear-facing child restraint on the rear seat.
- If you install a rear-facing child restraint on the front-passenger seat, make sure the  **PASS AIR BAG OFF** indicator lamp is illuminated, indicating that the front-passenger front air bag is deactivated. Should the  **PASS AIR BAG OFF** indicator lamp not illuminate or go out while the restraint is installed, please check installation. Periodically check the  **PASS AIR BAG OFF** indicator lamp while driving to make sure the  **PASS AIR BAG OFF** indicator lamp is illuminated. If the  **PASS AIR BAG OFF** indicator lamp goes out or remains out, do not transport a child on the front-passenger seat until the system has been repaired. A child in a rear-facing child restraint on the front-passenger seat will be seriously injured or even killed if the front-passenger front air bag inflates.

- If you place a child in a forward-facing child restraint on the front-passenger seat:
 - move the seat as far back as possible
 - use the proper child restraint recommended for the age, size and weight of the child
 - secure child restraint with the vehicle's seat belt according to the child seat manufacturer's instructions
- For children larger than a typical 12-month-old child, the front-passenger front air bag can be activated or deactivated.

WARNING

Infants and small children should never share a seat belt with another occupant. During an accident, they could be crushed between the occupant and seat belt.

A child's risk of serious or fatal injuries is significantly increased if the child restraints are not properly secured in the vehicle and/or the child is not properly secured in the child restraint.

Children too big for a toddler restraint must ride in seats using regular seat belts. Position the shoulder belt across the chest and shoulder, not face or neck. A booster seat may be necessary to achieve proper seat belt positioning for children over 41 lb (18 kg) until they reach a height where a lap/shoulder belt fits properly without a booster.

When the child restraint is not in use, remove it from the vehicle or secure it with the seat belt to prevent the child restraint from becoming a projectile in the event of an accident.

If an infant or child is traveling in the vehicle:

- ▶ Secure the infant or child with an appropriate infant or child restraint recommended for the child's age and weight.
- ▶ Make sure that the infant or child is properly secured at all times while the vehicle is in motion.

⚠ WARNING

When leaving the vehicle, always remove the SmartKey from the ignition lock. Always take the SmartKey with you and lock the vehicle. Do not leave children unattended in the vehicle, even if they are secured in a child restraint system, or with access to an unlocked vehicle. A child's unsupervised access to a vehicle could result in an accident and/or serious personal injury. The children could:

- injure themselves on parts of the vehicle
- be seriously or fatally injured through excessive exposure to extreme heat or cold
- injure themselves or cause an accident with vehicle equipment that can be operated even if the SmartKey is removed from the ignition lock or removed from the vehicle, such as seat adjustment, steering wheel adjustment, or the memory function

If children open a door, they could injure other persons or get out of the vehicle and injure themselves or be injured by following traffic.

Do not expose the child restraint system to direct sunlight. The child restraint system's metal parts, for example, could become very hot, and the child could be burned on these parts.

⚠ WARNING

Do not carry heavy or hard objects in the passenger compartment or trunk unless they are firmly secured in place.

Unsecured or improperly positioned cargo increases a child's risk of injury in the event of

- strong braking maneuvers
- sudden changes of direction
- an accident

Special seat belt retractor

All seat belts except the driver's seat belt are equipped with a special seat belt retractor. When activated, the special seat belt

retractor ensures the seat belt will not slacken once the child restraint system has been secured.

Installing a child restraint system:

- ▶ Always comply with the manufacturer's installation instructions.
- ▶ Pull the seat belt smoothly from the inertia reel.
- ▶ Engage the seat belt tongue in the belt buckle.

Activating the special seat belt retractor:

- ▶ Pull the seat belt out fully and let the inertia reel retract it again. While the seat belt is retracting, you should hear a ratcheting sound. The special seat belt retractor is enabled.
- ▶ Push down on the child restraint system to take up any slack.

Removing a child restraint system/
deactivating the special seat belt retractor:

- ▶ Always comply with the manufacturer's installation instructions.
- ▶ Press the seat belt release button and guide the belt tongue to the belt outlet. The special seat belt retractor is deactivated.

⚠ WARNING

Never release the seat belt buckle while the vehicle is in motion, since the special seat belt retractor will be deactivated.

LATCH-type (ISOFIX) child seat anchors in the rear**⚠ WARNING**

Children that are too large for a child restraint must travel in seats using normal seat belts. Position shoulder belt across the chest and shoulder, not face or neck.

In order to attain the correct seating position for children weighing over 41 lb (18 kg), it may be necessary to use a booster seat until they reach a height where a normal lap/shoulder

seat belt lies properly across their bodies without the need for a booster seat.

Install the child restraint system according to the manufacturer's instructions.

The child restraint system must be installed firmly on both brackets.

An incorrectly installed child restraint system can come loose in the event of an accident, causing the child to be severely or fatally injured.

Child restraint systems/child restraint retaining brackets that are damaged or have suffered damage due to an impact must be replaced.

LATCH-type (ISOFIX) is a standardized securing system for specially designed child restraint systems on the rear seats.

Securing rings for two LATCH-type (ISOFIX) child restraint systems are installed on the left and right:

- on the seat cushions of the outer seats in the second row
- on the backrests of the seats in the third row of seats

Secure non LATCH-type (ISOFIX) child restraint systems using the vehicle's seat belt system. Always install child restraint systems according to the manufacturer's instructions.

- ▶ Move the rear seat backrests in the second row to an upright position (▷ page 101).

The securing rings on the outer seats in the second row of seats are covered by an upholstered lining.

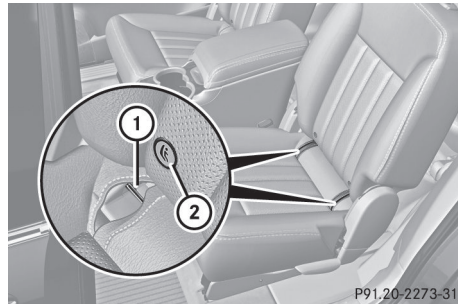

- ① Securing rings for outer seats in the second row
- ② Installation instructions for the securing ring

- ▶ Slide the upholstered lining to the side.
- ▶ Install the LATCH-type (ISOFIX) child restraint system. Comply with the manufacturer's instructions when doing so.

The securing rings on the seats in the third row are covered by protective caps.

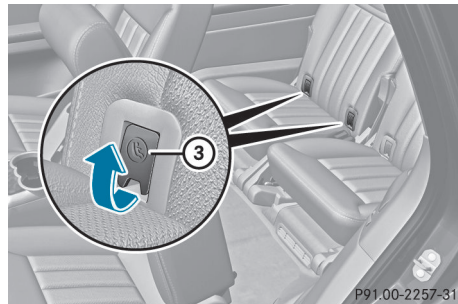

- ▶ Remove protective caps ③ in the third row of seats.

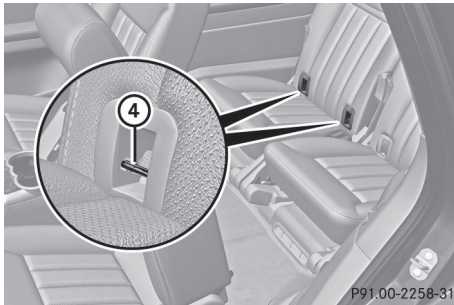

④ Securing rings for the third row of seats

- ▶ Install the LATCH-type (ISOFIX) child restraint system. Comply with the manufacturer's instructions when installing the LATCH-type (ISOFIX) child restraint system.

Top Tether

Top Tether anchorages

WARNING

Observe "Important safety notes" (▷ page 56).

Top Tether provides an additional connection between a child restraint system, secured with a LATCH-type (ISOFIX) child seat mount, and the rear seat. It helps reduce the risk of injury even further.

The Top Tether anchorages are:

- in the 2nd row of seats on the rear of the backrests of the outer seats and on the vehicle floor behind the center seat
- in the 3rd row of seats on the rear of the backrests

Outer seats in the 2nd and 3rd row

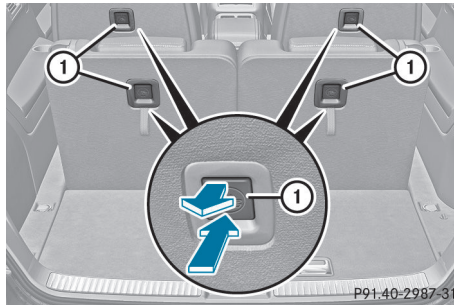

- ▶ Remove respective covering cap ① of the Top Tether anchorage.
- ▶ Move the head restraint upwards.
- ▶ Tilt the rear seat backrest forwards (▷ page 253).

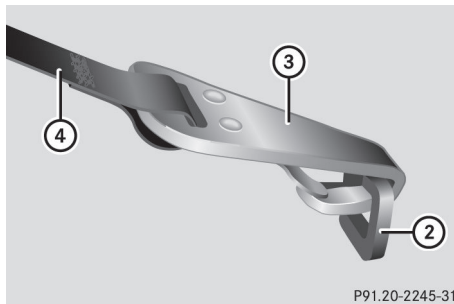
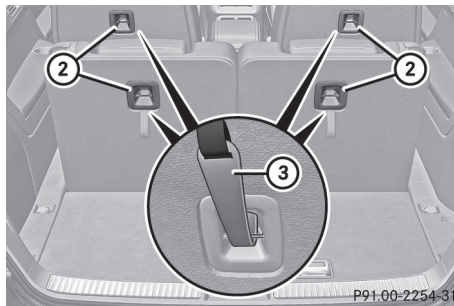

- ▶ Route Top Tether belt ④ under the head restraint between the two head restraint bars.
- ▶ Hook Top Tether hook ③ of Top Tether belt ④ into Top Tether anchorage ②.

Ensure that:

- Top Tether hook ③ is hooked into Top Tether anchorage ② as shown
- Top Tether belt ④ is not twisted
- Top Tether belt ④ is routed between the seat backrest and the cargo compartment cover if the cargo compartment cover is installed.
- Top Tether belt ④ is routed between the seat backrest and the cargo net if the cargo net is installed.

WARNING

Do not secure the Top Tether hook to the loop underneath the Top Tether anchorage if you are securing a child restraint system in the third row of seats. The child restraint system is not secured if you do so. An incorrectly fitted child restraint system cannot perform its intended protective function in the event of an accident, and could lead to injuries.

- ▶ Swing back the seat backrest until it engages (▷ page 253).
The outer seats in the second row are only locked if the lock verification indicator is folded in and the indicator area is barely visible (▷ page 253).

WARNING

Make sure that the seats are locked and that the backrests are locked in a vertical position after fitting the Top Tether belt.

The outer seats in the second row are only locked if the lock verification indicator is folded in and the indicator area is barely visible.

If the backrests are not locked, they could fold forwards in the event of an accident, sudden braking or a sudden change of direction. Instead of restraining an occupant, they could cause additional serious or even fatal injury.

- ▶ Move the head restraint back down again slightly if necessary (▷ page 100). Make

sure that you do not interfere with the correct routing of Top Tether belt ④.

- ▶ Install the LATCH-type (ISOFIX) child restraint system with Top TetherComply with the manufacturer's installation instructions when doing so. Make sure that Top Tether belt ④ is tight.

Center seat in the 2nd row

WARNING

Only secure a child restraint system on the center seat in the second row when the belt buckles of the outer seats are not obstructed or overlapped by the child restraint system. Not all child restraint systems, including some Mercedes-Benz approved child restraint systems, can be used in this seat position. For further information contact an authorized Mercedes-Benz Center.

Do not use the LATCH-type anchors (ISOFIX) or seat belt buckles for the outer seats in conjunction with a child seat in the second-row center seat. Child seats in the center seating position must only be secured by the center seat position seat belt inserted into the seat belt buckle for the second-row center seat.

WARNING

Please be aware that installation of a child seat in the second-row center seat position can prevent the folding forward of the outer second-row seats which can obstruct access to and exit from the third-row seats. This could affect the occupants' on the third-row seats ability to exit the vehicle. In case of an accident it will be difficult for occupants of the third-row seats to leave the vehicle. Serious injuries could be the result.

Install a child seat in one of the outer seating positions according to the installation instructions if access to the third-row seats is required.

- ▶ Move the head restraint upwards.

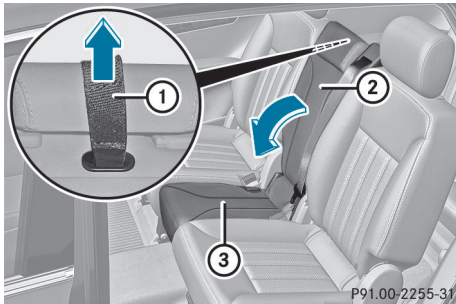

- ▶ Pull release loop ① in the direction of the arrow.

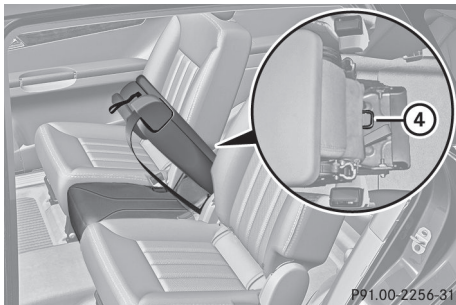

- ▶ Fold seat backrest ② forward in the direction of seat cushion ③ until Top Tether anchorage ④ is accessible.

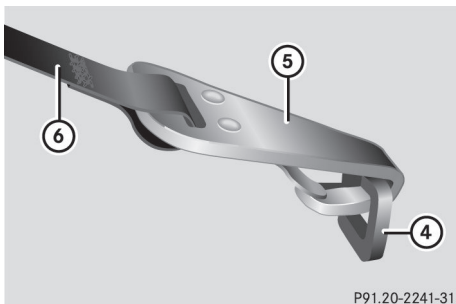

- ▶ Route Top Tether belt ⑥ under the head restraint between the two head restraint bars.
- ▶ Hook Top Tether hook ⑤ of Top Tether belt ⑥ into Top Tether anchorage ④.

Ensure that:

- Top Tether hook ⑤ is hooked into Top Tether anchorage ④ as shown
 - Top Tether belt ⑥ is not twisted
 - Top Tether belt ⑥ is routed between the seat backrest and the cargo compartment cover if the cargo compartment cover is installed.
 - Top Tether belt ⑥ is routed between the seat backrest and the cargo net if the cargo net is installed.
- ▶ Swing back the seat backrest until it engages audibly (▷ page 253).

WARNING

Always lock the rear seat backrests in their upright position when the rear seats are occupied by passengers. Lock the rear seat backrests in their upright position after installing the TopTether straps or when the extended cargo compartment is not in use. Make sure that rear seat backrests are secured properly by pushing and pulling on the seat backrests. If the seat backrest is not locked properly, the seat backrest could fold. The child restraint system is no longer supported properly or held in position and can no longer fulfill its function. That could cause serious or even fatal injuries.

- ▶ Move the head restraint back down again slightly if necessary (▷ page 100). Make sure that you do not interfere with the correct routing of Top Tether belt ⑥.
- ▶ Install the LATCH-type (ISOFIX) child restraint system with Top Tether. Comply with the manufacturer's installation instructions when doing so. Make sure that Top Tether belt ⑥ sits taut.

Child-proof locks

Important safety notes

WARNING

When leaving the vehicle, always remove the SmartKey from the ignition lock. Always take the SmartKey with you and lock the vehicle. Do not leave children unattended in the vehicle, even if they are secured in a child restraint system, or with access to an unlocked vehicle. A child's unsupervised access to a vehicle could result in an accident and/or serious personal injury. The children could:

- injure themselves on parts of the vehicle
- be seriously or fatally injured through excessive exposure to extreme heat or cold
- injure themselves or cause an accident with vehicle equipment that can be operated even if the SmartKey is removed from the ignition lock or removed from the vehicle, such as seat adjustment, steering wheel adjustment, or the memory function

If children open a door, they could injure other persons or get out of the vehicle and injure themselves or be injured by following traffic.

Do not expose the child restraint system to direct sunlight. The child restraint system's metal parts, for example, could become very hot, and the child could be burned on these parts.

Child-proof locks for the rear doors

WARNING

Children could open a rear door from inside the vehicle. This could result in serious injuries or an accident. Therefore, when children ride in the rear always secure the rear doors with the child-proof locks.

You secure each door individually with the child-proof locks on the rear doors. A door secured with a child-proof lock cannot be opened from inside the vehicle. When the

vehicle is unlocked, the door can be opened from the outside.

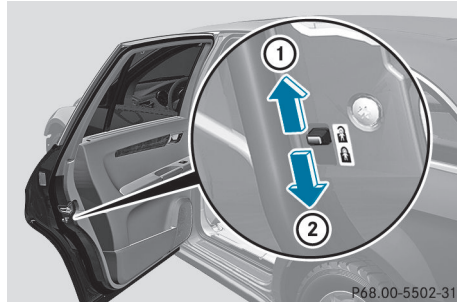

- ▶ **To activate:** press the child-proof lock lever down in the direction of arrow ②.
- ▶ Make sure that the child-proof locks are working properly.
- ▶ **To deactivate:** press the child-proof lock lever up in the direction of arrow ①.

Override feature for the rear side windows

WARNING

When children ride on the vehicle's rear seats, activate the override switch. Otherwise, the children could be injured, e.g. by trapping themselves in the rear side window.

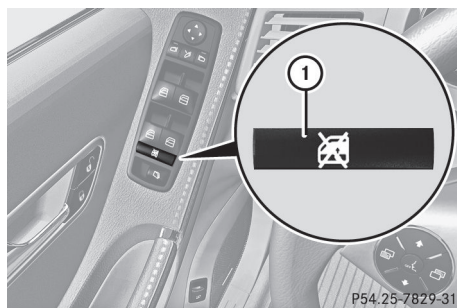

- ▶ **To activate/deactivate:** press switch ①. Switch ① is pushed in or extended. If the switch has engaged, operation of the rear side windows is deactivated. Operation is then only possible using the switches in the driver's door.

Panic alarm

Safety



- ▶ **To activate:** press **PANIC** button ① for at least one second.
An alarm sounds and the exterior lighting flashes.
 - ▶ **To deactivate:** press **PANIC** button ① again.
- or
- ▶ Insert the SmartKey into the ignition lock.
- or
- ▶ Press the KEYLESS-GO Start/Stop button.
The KEYLESS-GO key must be in the vehicle.

i USA only:

This device complies with Part 15 of the FCC Rules. Operation is subject to the following two conditions:

1. This device may not cause interference, and
2. this device must accept any interference received, including interference that may cause undesired operation.

Any unauthorized modification to this device could void the user's authority to operate the equipment.

The product label with FCC ID and IC certification number can be found in the battery case of the SmartKey.

i Canada only:

This device complies with RSS-Gen of Industry Canada. Operation is subject to the following two conditions:

1. This device may not cause harmful interference, and
2. this device must accept any interference received, including interference that may cause undesired operation.

Any unauthorized modification to this device could void the user's authority to operate the equipment.

The product label with FCC ID and IC certification number can be found in the battery case of the SmartKey.

Driving safety systems

Driving safety systems overview

In this section, you will find information about the following driving safety systems:

- ABS (**A**nti-**l**ock **B**raking **S**ystem)
- BAS (**B**rake **A**ssist **S**ystem)
- ESP® (**E**lectronic **S**tability **P**rogram)
- EBD (**E**lectronic **B**rake force **D**istribution)
- Distance warning function (vehicles with DISTRONIC)

Important safety notes

⚠ WARNING

The following factors increase the risk of accidents:

- Excessive speed, especially in turns
- Wet and slippery road surfaces
- Following another vehicle too closely

The driving safety systems described in this section cannot reduce these risks or prevent the natural laws of physics from acting on the vehicle. They cannot increase braking or steering efficiency beyond that afforded by the condition of the vehicle brakes and tires or the traction afforded.

Only a safe, attentive, and skillful driver can prevent accidents.

The capabilities of a vehicle equipped with the driving safety systems described in this

section must never be exploited in a reckless or dangerous manner which could jeopardize the user's safety or the safety of others.

Always adjust your driving style to the prevailing road and weather conditions and keep a safe distance to other road users and objects on the street.

If a driving system malfunctions, other driving safety systems may also switch off. Observe indicator and warning lamps that may come on as well as messages in the multifunction display that may appear.

- i** Please note that the driving safety systems described only work as effectively as possible when there is adequate contact between the tires and the road surface. Pay particular attention to the information regarding tires, recommended minimum tire tread depths etc. in the "Wheels and tires" section (▷ page 322).

In wintry driving conditions, always use winter tires (M+S tires) and if necessary, snow chains. Only in this way will the driving safety systems described in this section work as effectively as possible.

ABS (Anti-lock Braking System)

Important safety notes

- i** Observe the "Important safety notes" section (▷ page 64).

ABS regulates brake pressure in such a way that the wheels do not lock when you brake. This allows you to continue steering the vehicle when braking.

ABS works from a speed of about 5 mph (8 km/h) upwards, regardless of road-surface conditions. ABS works on slippery surfaces, even when you only brake gently.

WARNING

If the ABS malfunctions, other driving systems such as the BAS or the ESP® are also switched off. Observe indicator and warning lamps that

may come on as well as messages in the multifunction display that may appear.

If the ABS malfunctions, the wheels may lock during hard braking, reducing the steering capability and extending the braking distance.

The  warning lamp in the instrument cluster lights up when the ignition is switched on. It goes out when the engine is running.

Braking

If ABS intervenes when braking, you will feel a pulsing in the brake pedal.

- ▶ **If ABS intervenes:** continue to depress the brake pedal with force until the braking situation is over.
- ▶ **To make a full brake application:** depress the brake pedal with full force.

The pulsating brake pedal can be an indication of hazardous road conditions, and functions as a reminder to take extra care while driving.

WARNING

Do not pump the brake pedal. Use firm, steady brake pedal pressure instead. Pumping the brake pedal defeats the purpose of the ABS and significantly reduces braking effectiveness.

BAS (Brake Assist System)

- i** Observe the "Important safety notes" section (▷ page 64).

BAS operates in emergency braking situations. If you depress the brake pedal quickly, BAS automatically boosts the braking force, thus shortening the stopping distance.

- ▶ Keep the brake pedal firmly depressed until the emergency braking situation is over. ABS prevents the wheels from locking.

The brakes will function as usual once you release the brake pedal. BAS is deactivated.

⚠ WARNING

If the BAS malfunctions, the brake system still functions, but without the additional brake boost available that the BAS would normally provide in an emergency braking maneuver. Therefore, the braking distance may increase.

ESP® (Electronic Stability Program)**Important safety notes**

- i** See the "Important safety notes" section (▷ page 64).

If ESP® detects that the vehicle is deviating from the direction desired by the driver, one or more wheels are braked to stabilize the vehicle. If necessary, the engine output is also modified to keep the vehicle on the desired course within physical limits. ESP® assists the driver when pulling away on wet or slippery roads. ESP® can also stabilize the vehicle during braking.

If ESP® intervenes, the  ESP® warning lamp flashes in the instrument cluster.

⚠ WARNING

Under no circumstances should you deactivate ESP® when the  ESP® warning lamp in the instrument cluster flashes. Proceed as follows:

- when driving off, apply as little throttle as possible.
- while driving, ease up on the accelerator pedal.
- adapt your speed to suit the prevailing road and weather conditions.

Failure to observe these guidelines could cause the vehicle to skid. ESP® cannot prevent accidents resulting from excessive speed.

- !** Only operate the vehicle for a maximum of ten seconds on a brake test dynamometer. Switch off the ignition.

Application of the brakes by ESP® may otherwise destroy the brake system.

- !** Function or performance tests may only be performed on a 2-axle dynamometer. If you wish to operate the vehicle on such a dynamometer, please consult an authorized Mercedes-Benz Center beforehand. You could otherwise damage the drive train or the brake system.

- i** Only use wheels with the recommended tire sizes. Only then will ESP® function properly.

4ETS (Electronic Traction System)

- i** Observe the "Important safety notes" section (▷ page 64).

Traction control is part of ESP®.

Traction control brakes the drive wheels individually if they spin. This enables you to pull away and accelerate on slippery surfaces, for example if the road surface is slippery on one side. In addition, more drive torque is transferred to the wheel or wheels with traction.

Traction control remains active if you deactivate ESP®.

⚠ WARNING

Traction control cannot reduce the risk of an accident if you drive too fast. Traction control cannot override the laws of physics.

Deactivating/activating ESP®

- i** Observe the "Important safety notes" section (▷ page 64).

⚠ WARNING

ESP® should not be deactivated during normal driving other than in the circumstances described below. Disabling the system will reduce vehicle stability in driving maneuvers.

Do not deactivate ESP® when the emergency or spare wheel is mounted.

ESP® is activated automatically when the engine is started.

It may be best to deactivate ESP® in the following situations:

- when using snow chains
- in deep snow
- on sand or gravel

WARNING

Switch on ESP® immediately if one of the previously stated conditions is no longer met. Otherwise, ESP® cannot stabilize the vehicle if it begins to lurch or when a wheel spins.

When you deactivate ESP®:

- ESP® no longer improves driving stability.
- the engine's torque is no longer limited and the drive wheels can spin. The spinning of the wheels results in a cutting action, which provides better grip.
- traction control is still activated.
- ESP® still provides support when you brake.

If ESP® is deactivated and one or more wheels start to spin, the  ESP® warning lamp in the instrument cluster flashes. In such situations, ESP® will not stabilize the vehicle.





▶ **To deactivate:** press button .

The  ESP® OFF warning lamp in the instrument cluster lights up.

WARNING

When the  ESP® OFF warning lamp is lit, ESP® is deactivated.

If the  ESP® warning lamp and the  ESP® OFF warning lamp remain lit, ESP® is not available due to a malfunction.

When ESP® is deactivated or not operational, vehicle stability in standard driving maneuvers is reduced.

Adapt your speed and driving to the prevailing road conditions and to the non-operating status of the ESP®.

 Avoid spinning the driven wheels for an extended period with ESP® deactivated. You could otherwise damage the drivetrain.

▶ **To activate:** press button .

The  ESP® OFF warning lamp in the instrument cluster goes out.

ESP® trailer stabilization

If your vehicle with trailer (vehicle/trailer combination) begins to lurch, you can only stabilize the vehicle/trailer combination by depressing the brake firmly.

In this situation, ESP® assists you and can detect if the vehicle/trailer combination begins to lurch. ESP® slows the vehicle down by braking and limiting the engine output until the vehicle/trailer combination has stabilized.

Trailer stabilization is active from a speed of approximately 40 mph (65 km/h).

WARNING

The system will not be able to assist when the trailer jackknifes

- if the ESP® has switched off due to a malfunction
- on wet or icy roads
- on roads with slippery surface
- in sand or gravel

Trailers with a high center of gravity may tip over before the system recognizes swaying of the trailer.

Trailer stabilization does not work if ESP® is deactivated or disengaged because of a malfunction.

EBD (electronic brake force distribution)

- ❶ Observe the "Important safety notes" section (▷ page 64).

EBD monitors and controls the brake pressure on the rear wheels to improve driving stability while braking.



WARNING

If EBD has malfunctioned, the braking system remains available with full brake boosting effect. However, the rear wheels can still lock, e.g. under full braking. This could cause you to lose control of your vehicle and cause an accident. You should therefore adapt your driving style to the different handling characteristics.

- ▶ Observe the notes on warning and indicator lamps (▷ page 240) as well as display messages (▷ page 216).

Distance warning function (vehicles with DISTRONIC)

This function provides a warning from a speed of approximately 20 mph (30 km/h), if:

- for a period of several seconds, the distance to the vehicle in front is too short for the speed at which you are traveling. The  distance warning lamp in the instrument cluster will light up.
- you are rapidly approaching the vehicle in front. An intermittent warning tone will then sound and the  distance warning lamp will light up in the instrument cluster.

You must apply the brakes yourself in order to maintain the appropriate distance to the vehicle in front and prevent a collision.

WARNING

If the distance warning lamp  in the instrument cluster comes on while driving and/or an intermittent warning sounds, immediate attention on the part of the driver is required. As required by the traffic situation, apply the brakes and navigate around a possible obstacle. However, do not drive by relying on the distance warning function, as this will result in an emergency braking application. This will not always enable you to avoid a collision, especially when traveling on varying road surface conditions and with varying driver reaction. Complex driving situations are not always fully recognized by the distance warning function. This could result in wrong or missing distance warnings.

- ▶ **To activate/deactivate:** activate or deactivate the distance warning function in the on-board computer (▷ page 210). After activation, the  symbol is displayed in the lower multifunction display.

Theft deterrent locking systems

Immobilizer

The immobilizer prevents your vehicle from being started without the correct SmartKey. When leaving the vehicle, always take the SmartKey with you and lock the vehicle. The engine can be started by anyone with a valid SmartKey that is left inside the vehicle.

- ▶ **To activate with the SmartKey:** remove the SmartKey from the ignition lock.
- ▶ **To activate with KEYLESS-GO:** switch the ignition off and open the driver's door.
- ▶ **To deactivate:** switch on the ignition.

i The immobilizer is always deactivated when you start the engine.

In the event that the engine cannot be started when the starter battery is fully charged, the immobilizer may be faulty. Contact an authorized Mercedes-Benz Center or call 1-800-FOR-MERCEDES (in USA) or 1-800-387-0100 (in Canada).

ATA (Anti-Theft Alarm system)

A visual and audible alarm is triggered if the alarm system is armed and you open:

- a door
- the vehicle with the mechanical key
- the tailgate
- the hood

The alarm is not switched off, even if you close the open door that has triggered it, for example.

i If the alarm stays on for more than 30 seconds, the emergency call system mbrace (USA only) or TELE AID (Canada only) initiates a call to the Customer Assistance Center automatically. The emergency call system initiates the call provided that:

- you have subscribed to the mbrace/TELE AID service.
- the mbrace/TELE AID service has been activated properly.
- the required mobile phone, power supply and GPS are available.



► **To arm:** lock the vehicle with the SmartKey or KEYLESS-GO.

Indicator lamp ① flashes. The alarm system is armed after approximately 10 seconds.

► **To deactivate:** unlock the vehicle with the SmartKey or KEYLESS-GO.

► **To stop the alarm using the SmartKey:** insert the SmartKey into the ignition lock. The alarm is switched off.

or

► Press the  or  button on the SmartKey.

The alarm is switched off.

► **To stop the alarm using KEYLESS-GO:** grasp the outside door handle. The SmartKey must be outside the vehicle. The alarm is switched off.

or

► Press the Start/Stop button on the dashboard. The SmartKey must be inside the vehicle.

The alarm is switched off.

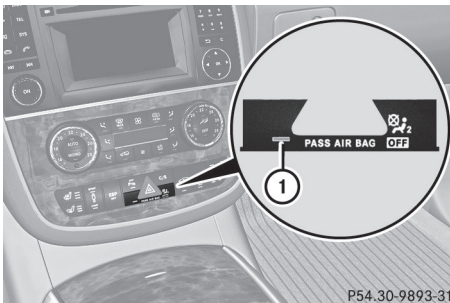

P54.30-9893-31

Useful information	72
SmartKey	72
Doors	79
Cargo compartment	81
Side windows	86
Sliding sunroof	89

Useful information

- i** This Operator's Manual describes all models and all standard and optional equipment of your vehicle available at the time of publication of the Operator's Manual. Country-specific differences are possible. Please note that your vehicle may not be equipped with all features described. This also applies to safety-related systems and functions.
- i** Please read the information on qualified specialist workshops (▷ page 24).

SmartKey

Important safety notes

WARNING

When leaving the vehicle, always remove the SmartKey from the ignition lock. Always take the SmartKey with you and lock the vehicle. Do not leave children unsupervised in the vehicle, even if they are secured in a child restraint system, and do not give them access to an unlocked vehicle. A child's unsupervised access to a vehicle could result in an accident and/or serious personal injury. They could:

- injure themselves on vehicle parts
- be seriously or fatally injured by extreme heat or cold
- injure themselves or have an accident with vehicle equipment that may still be in operation even after the SmartKey has been removed from the ignition, such as the seat adjustment, steering wheel adjustment or memory function.

If children open a door, they could cause severe or even fatal injury to other persons; if they get out of the vehicle, they could injure themselves when doing so or be seriously or even fatally injured by any passing traffic.

Do not expose the child restraint system to direct sunlight. The child restraint system's metal parts, for example, could become very

hot, and a child could be burned on these parts.

WARNING

If a key ring is too heavy or too large, the weight acting on the key could cause it to turn in the ignition lock or catch on the steering wheel. This could cause the engine to be switched off suddenly. You could lose control of the vehicle and cause an accident. Do not attach any heavy or large key rings to the key that is inserted in the ignition.

General information

If you cannot lock or unlock the vehicle with the SmartKey, either the battery in the SmartKey is discharged, the SmartKey is faulty or the starter battery is discharged.

- ▶ Check the battery in the SmartKey and replace it if necessary (▷ page 76).
- ▶ Unlock the driver's door using the mechanical key (▷ page 81).
- ▶ Lock the vehicle (▷ page 81).
- ▶ Have the starter battery and battery contacts checked at an authorized Mercedes-Benz Center.

If the SmartKey is faulty, contact Roadside Assistance or an authorized Mercedes-Benz Center.

SmartKey functions

General notes

- i** USA only:

This device complies with Part 15 of the FCC Rules. Operation is subject to the following two conditions:

1. This device may not cause harmful interference, and
2. this device must accept any interference received, including interference that may cause undesired operation.

Any unauthorized modification to this device could void the user's authority to operate the equipment.

The product label with FCC ID and IC certification number can be found in the battery case of the SmartKey.

i Canada only:

This device complies with RSS-210 of Industry Canada. Operation is subject to the following two conditions:

1. This device may not cause interference, and
2. this device must accept any interference received, including interference that may cause undesired operation of the device.

Any unauthorized modification to this device could void the user's authority to operate the equipment.

The product label with FCC ID and IC certification number can be found in the battery case of the SmartKey.

Locking and unlocking centrally

The SmartKey centrally locks/unlocks:

- the doors
- the tailgate
- the fuel filler flap

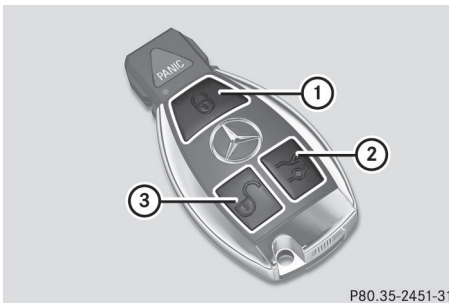

- ① Locks the vehicle
- ② Opens/closes the tailgate
- ③ Unlocks the vehicle

When unlocking, the turn signals flash once.
When locking, they flash three times.

When it is dark, the surround lighting also comes on if it is activated in the on-board computer (> page 207).

You can also set an audible signal to confirm that the vehicle has been locked or unlocked. The audible signal can be activated and deactivated using the on-board computer (> page 208).

► **To unlock centrally:** press the button.

If you do not open the vehicle within approximately 40 seconds of unlocking:

- the vehicle is locked again.
- the theft deterrent locking system is armed again.

► **To lock centrally:** press the button.

KEYLESS-GO

General notes

i USA only:

This device complies with Part 15 of the FCC Rules. Operation is subject to the following two conditions:

1. This device may not cause harmful interference, and
2. this device must accept any interference received, including interference that may cause undesired operation.

Any unauthorized modification to this device could void the user's authority to operate the equipment.

The product label with FCC ID and IC certification number can be found in the battery case of the SmartKey.

i Canada only:

This device complies with RSS-210 of Industry Canada. Operation is subject to the following two conditions:

1. This device may not cause interference, and

2. this device must accept any interference received, including interference that may cause undesired operation of the device.

Any unauthorized modification to this device could void the user's authority to operate the equipment.

The product label with FCC ID and IC certification number can be found in the battery case of the SmartKey.

Important notes on the use of KEYLESS-GO

- The KEYLESS-GO key can be used like a conventional key.
- You can combine KEYLESS-GO functions with those of a conventional key, e.g. unlock with KEYLESS-GO and lock with the  button.
- Always carry your KEYLESS-GO key on your person.
- Do not keep the KEYLESS-GO key together with:
 - electronic devices, e.g. a mobile phone or another key
 - metallic objects, e.g. coins or metal foil.
 This can affect the functionality of KEYLESS-GO.
- When locking and unlocking using KEYLESS-GO, the distance between the SmartKey and the corresponding door handle must not exceed 3 ft (1 m).
- If the vehicle is parked for more than 72 hours, the KEYLESS-GO function is deactivated. Pull the outer door handle and switch on the ignition to reactivate the KEYLESS-GO function.
- If the KEYLESS-GO key is removed from the vehicle, it is possible that the system may not recognize the SmartKey. The vehicle

can then not be locked or started using KEYLESS-GO.

- If the KEYLESS-GO key has been removed from the vehicle, e.g. if a passenger leaves the vehicle with a KEYLESS-GO key:
 - if the Start/Stop button is pressed or if an attempt is made to lock the vehicle with the locking button on the outer door handle, the **Key Not Detected** message appears in the multifunction display
 - while the engine is running, the red **Key Not Detected** message will appear in the multifunction display as you pull away. Find the KEYLESS-GO key and change its position in the vehicle. Carry the KEYLESS-GO key in your shirt pocket, for example.
- If you have started the engine with the Start/Stop button, you can switch it off again by:
 - pressing the Start/Stop button again
 - inserting the KEYLESS-GO key into the ignition lock if the vehicle is stationary and the automatic transmission is in park position **P**.
- You could unlock the vehicle by mistake if the distance between the KEYLESS-GO key and the vehicle is less than 3 ft (1 m) and:
 - an exterior door handle is hit by a water jet
 - or
 - you clean an exterior door handle.
- Bear in mind that the engine can be started by any of the vehicle occupants if there is a KEYLESS-GO key in the vehicle.

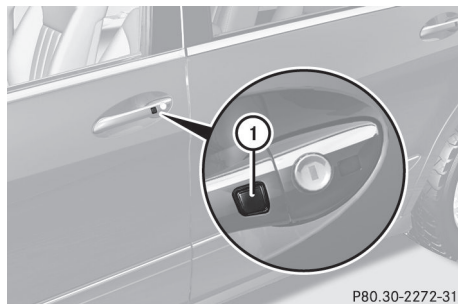





- ▶ **To unlock the vehicle:** touch the inner surface of the door handle.
- ▶ **To lock the vehicle:** press locking button ①.
- ▶ **Convenience closing feature:** press locking button ① for an extended period (▷ page 88).



If you pull on the handle of the tailgate, only the cargo compartment of the vehicle is unlocked.

Changing the settings of the locking system

You can change the setting of the locking system in such a way that only the driver's door and the fuel filler flap are unlocked. This is useful if you frequently travel on your own.

- ▶ **To change the setting:** press and hold down the  and  buttons simultaneously for approximately six seconds until the battery check lamp (▷ page 76) flashes twice.
- i** If the setting of the locking system is changed within the signal range of the vehicle, pressing the  or  button locks or unlocks the vehicle.



The SmartKey now functions as follows:

- ▶ **To unlock the driver's door:** press the  button once.
- ▶ **To unlock centrally:** press the  button twice.
- ▶ **To lock centrally:** press the  button.

The KEYLESS-GO function is changed as follows:

- ▶ **To unlock the driver's door:** touch the inner surface of the door handle on the driver's door.
- ▶ **To unlock centrally:** touch the inner surface of the door handle on the front-passenger door or the rear door.
- ▶ **To lock centrally:** press the locking button on one of the door handles.

Restoring the factory settings

- ▶ Press the  and  buttons simultaneously for approximately six seconds until the battery check lamp flashes twice.



Mechanical key

General notes

If the vehicle can no longer be unlocked with the SmartKey, use the mechanical key.

If you use the mechanical key to unlock and open the driver's door, the anti-theft alarm system will be triggered (▷ page 69).

There are several ways to turn off the alarm:

- ▶ **To turn the alarm off with the SmartKey:** press the  or  button on the SmartKey.

or

- ▶ Insert the SmartKey into the ignition lock.

or

- ▶ **To deactivate the alarm with KEYLESS-GO:** press the Start/Stop button in the ignition lock. The SmartKey must be in the vehicle.

or

- ▶ Lock or unlock the vehicle using KEYLESS-GO. The SmartKey must be outside the vehicle.

Removing the mechanical key

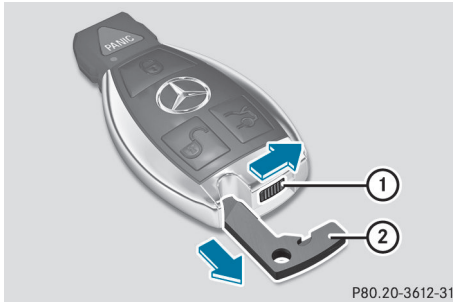

P80.20-3612-31

- ▶ Push release catch ① in the direction of the arrow and at the same time, remove mechanical key ② from the SmartKey.

SmartKey battery

Important safety notes

It is advisable to have batteries replaced at a qualified specialist workshop, e.g. at an authorized Mercedes-Benz Center.

WARNING

Batteries contain toxic and caustic substances. For this reason, keep batteries out of the reach of children.

If a battery has been swallowed, seek medical help immediately.



WARNING

The SmartKey batteries contain perchlorate material, which may require special handling and regard for the environment. Observe government disposal guidelines. California residents, see www.dtsc.ca.gov/HazardousWaste/Perchlorate/index.cfm.





Checking the battery



P80.35-2454-31

- ▶ Press the  or  button. The SmartKey battery is working properly if battery check lamp ① lights up briefly.

If battery check lamp ① does not light up briefly during the test, the SmartKey battery is discharged.

- ▶ Changing the battery (▷ page 76)
-  The battery can be obtained from any authorized Mercedes-Benz Center.
-  If the SmartKey battery is checked within the signal reception range of the vehicle, pressing the  or  button locks or unlocks the vehicle.

Changing the battery

You require a CR 2025 3 V cell battery.

- ▶ Take the mechanical key out of the SmartKey (▷ page 75).

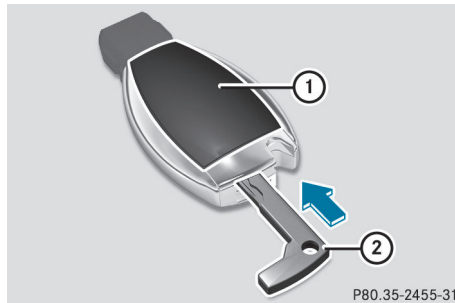

P80.35-2455-31

- ▶ Press mechanical key ② into the opening in the SmartKey in the direction of the





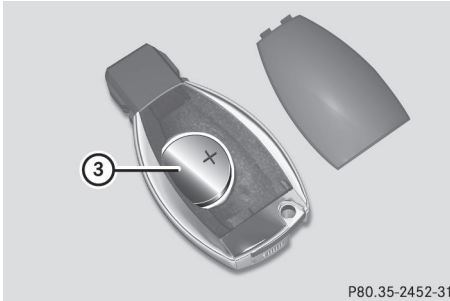

arrow until battery tray cover ① opens.
When doing so, do not hold cover ① shut.

- ▶ Remove battery tray cover ①.



- ▶ Repeatedly tap the SmartKey against your palm until battery ③ falls out.
- ▶ Insert the new battery with the positive terminal facing upwards. Use a lint-free cloth to do so.
- ▶ Make sure that the surface of the battery is free from lint, grease and all other forms of contamination.
- ▶ Insert the front tabs of battery tray cover ① and then press to close it.
- ▶ Insert the mechanical key into the SmartKey.
- ▶ Check the function of all SmartKey buttons on the vehicle.

Problems with the SmartKey

Problem	Possible causes/consequences and ► Solutions
<p>You cannot lock or unlock the vehicle using the SmartKey.</p>	<p>The SmartKey battery is discharged or nearly discharged.</p> <ul style="list-style-type: none"> ► Try again to lock/unlock the vehicle using the remote control function of the SmartKey. Point the tip of the SmartKey at the driver's door handle from close range and press the  /  button. <p>If this does not work:</p> <ul style="list-style-type: none"> ► Check the SmartKey battery and replace it if necessary (▷ page 76). ► Lock (▷ page 81) or unlock (▷ page 81) the vehicle using the mechanical key. <p>The SmartKey is faulty.</p> <ul style="list-style-type: none"> ► Lock (▷ page 81) or unlock (▷ page 81) the vehicle using the mechanical key. ► Have the SmartKey checked at a qualified specialist workshop.
<p>You can no longer lock or unlock the vehicle using KEYLESS-GO.</p>	<p>KEYLESS-GO is in standby mode because the vehicle has not been unlocked for an extended period.</p> <ul style="list-style-type: none"> ► Pull the door handle twice and then insert the SmartKey into the ignition lock. <p>There is interference from a powerful source of radio waves.</p> <ul style="list-style-type: none"> ► Lock/unlock the vehicle using the remote control function of the SmartKey. Point the tip of the SmartKey at the driver's door handle from close range and press the  /  button. <p>There is a malfunction with KEYLESS-GO.</p> <ul style="list-style-type: none"> ► Lock/unlock the vehicle using the remote control function of the SmartKey. Point the tip of the SmartKey at the driver's door handle from close range and press the  /  button. ► Have KEYLESS-GO checked at a qualified specialist workshop. <p>If this does not work:</p> <ul style="list-style-type: none"> ► Check the SmartKey battery and replace it if necessary (▷ page 76). ► Lock (▷ page 81) or unlock (▷ page 81) the vehicle using the mechanical key.
<p>You have lost a SmartKey.</p>	<ul style="list-style-type: none"> ► Have the SmartKey canceled at an authorized Mercedes-Benz Center. ► Report the loss immediately to the vehicle insurers. ► If necessary, have the locks changed as well.

Problem	Possible causes/consequences and ► Solutions
You have lost the mechanical key.	<ul style="list-style-type: none"> ► Report the loss immediately to the vehicle insurers. ► If necessary, have the locks changed as well.
The engine cannot be started using the SmartKey.	<p>The on-board voltage is too low.</p> <ul style="list-style-type: none"> ► Switch off non-essential consumers, e.g. seat heating or interior lighting, and try to start the engine again. <p>If this does not work:</p> <ul style="list-style-type: none"> ► Check the starter battery and charge it if necessary (> page 310). <p>or</p> <ul style="list-style-type: none"> ► Jump-start the vehicle (> page 313). <p>or</p> <ul style="list-style-type: none"> ► Consult a qualified specialist workshop.
The engine cannot be started using KEYLESS-GO. The SmartKey is in the vehicle.	<p>A door is open. Therefore, the SmartKey cannot be detected as easily.</p> <ul style="list-style-type: none"> ► Close the door and try to start the vehicle again. <p>There is interference from a powerful source of radio waves.</p> <ul style="list-style-type: none"> ► Start your vehicle with the SmartKey in the ignition lock.

Doors

Important safety notes

WARNING

When leaving the vehicle, always remove the SmartKey from the ignition lock. Always take the SmartKey with you and lock the vehicle. Do not leave children unsupervised in the vehicle, even if they are secured in a child restraint system, and do not give them access to an unlocked vehicle. A child's unsupervised access to a vehicle could result in an accident and/or serious personal injury. They could:

- injure themselves on vehicle parts
- be seriously or fatally injured by extreme heat or cold
- injure themselves or have an accident with vehicle equipment that may still be in operation even after the SmartKey has been removed from the ignition, such as the

seat adjustment, steering wheel adjustment or memory function.

If children open a door, they could cause severe or even fatal injury to other persons; if they get out of the vehicle, they could injure themselves when doing so or be seriously or even fatally injured by any passing traffic.

Do not expose the child restraint system to direct sunlight. The child restraint system's metal parts, for example, could become very hot, and a child could be burned on these parts.

WARNING

Do not carry heavy or hard objects in the passenger compartment or cargo compartment unless they are firmly secured in place.

Unsecured or improperly positioned cargo increases a child's risk of injury in the event of

- strong braking maneuvers
- sudden changes of direction
- an accident

Unlocking and opening doors from the inside

You can open a door from inside the vehicle even if it has been locked. You can only open the rear doors from inside the vehicle if they are not secured by the child-proof locks (▷ page 63).

Only open the door when the traffic situation permits.

If the vehicle was previously locked with the SmartKey or with KEYLESS-GO, opening the vehicle from the inside will activate the anti-theft alarm system. Switch off the alarm (▷ page 69).

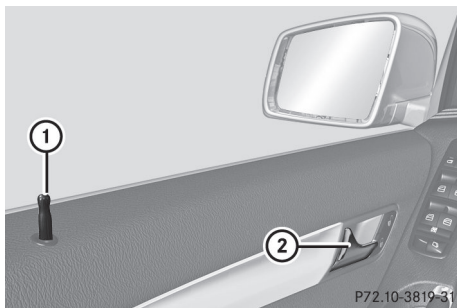

- ▶ Pull door handle ②.
If the door is locked, locking knob ① pops up. The door is unlocked and can be opened.

Centrally locking and unlocking the vehicle from the inside

You can centrally lock or unlock the vehicle from the inside.

The central locking/unlocking button does not lock or unlock the fuel filler flap. The buttons are located on both front doors.

- ❗ You cannot unlock the vehicle centrally from the inside if the vehicle has been locked with the SmartKey or KEYLESS-GO.
- ❗ It is only possible to lock the vehicle centrally if the front-passenger door is closed.

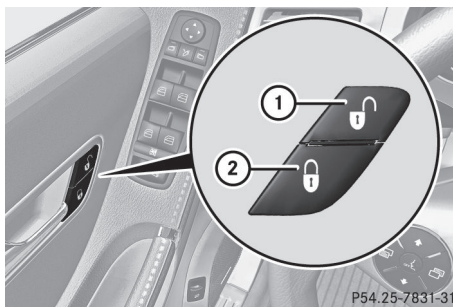

- ▶ **To unlock:** press button ①.
- ▶ **To lock:** press button ②.
If all the doors and the tailgate are closed, the vehicle locks.

You can open a front door from inside the vehicle even if it has been locked. Only open the door when the traffic situation permits. If the vehicle has been locked with the central locking button:

- and the SmartKey is set to its factory setting, the entire vehicle is unlocked if a front door is opened from the inside
- and the SmartKey is set to an individual setting, only the front door that is opened from inside the vehicle is unlocked.

If the vehicle has been locked centrally with the SmartKey or with KEYLESS-GO, it is not unlocked when the release button for the central locking is used.

Automatic locking feature

The vehicle locks automatically when the ignition is switched on and the wheels of the

vehicle are turning at a speed of more than 9 mph (15 km/h).

You could therefore be locked out when:

- the vehicle is being pushed.
- the vehicle is being towed.
- the vehicle is being tested on a dynamometer.

You can switch the automatic locking function on and off using the on-board computer (▷ page 208).

Unlocking the driver's door (mechanical key)

If the vehicle can no longer be unlocked with the SmartKey, use the mechanical key.

If you use the mechanical key to unlock and open the driver's door, the anti-theft alarm system will be triggered (▷ page 69).

- ▶ Take the mechanical key out of the SmartKey (▷ page 75).
- ▶ Insert the mechanical key into the lock of the driver's door as far as it will go.

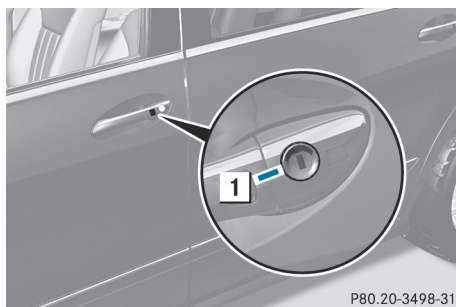

P80.20-3498-31

- ▶ Turn the mechanical key counter-clockwise as far as it will go to position **1** and hold it in this position.
- ▶ Pull the door handle beyond the first resistance.
The locking knob pops up.
The door is unlocked.
- ▶ Turn the mechanical key back and remove it.

- ▶ Pull the door handle again.
- ▶ Insert the mechanical key into the SmartKey.

Locking the vehicle

If the vehicle can no longer be locked with the SmartKey, you can lock it by taking the following steps.

- ▶ Close the front-passenger door, the rear door on the front-passenger side and the tailgate.
 - ▶ Open the driver's door and the rear door on the driver's side.
 - ▶ Press the locking button on the driver's door (▷ page 80).
The locking knobs in the front-passenger door and in the rear doors drop down.
 - ▶ Press down the locking knobs in the front-passenger and rear doors manually, if necessary.
 - ▶ Close the driver's door from the outside.
 - ▶ Press down the locking knob of the driver's door by reaching in through the open rear door.
- i** Make sure that you have the SmartKey on your person and that it has not been left in the vehicle.
- ▶ Close the rear door on the driver's side.
 - ▶ Make sure that the doors and the tailgate are locked.

- i** If you lock the vehicle as described above, the fuel filler flap is not locked. The anti-theft alarm system is not armed.

Cargo compartment

Important safety notes

Do not leave the SmartKey in the cargo compartment. You could otherwise lock yourself out.

⚠ WARNING

When leaving the vehicle, always remove the SmartKey from the ignition lock. Always take the SmartKey with you and lock the vehicle. Do not leave children unsupervised in the vehicle, even if they are secured in a child restraint system, and do not give them access to an unlocked vehicle. A child's unsupervised access to a vehicle could result in an accident and/or serious personal injury. They could:

- injure themselves on vehicle parts
- be seriously or fatally injured by extreme heat or cold
- injure themselves or have an accident with vehicle equipment that may still be in operation even after the SmartKey has been removed from the ignition, such as the seat adjustment, steering wheel adjustment or memory function.

If children open a door, they could cause severe or even fatal injury to other persons; if they get out of the vehicle, they could injure themselves when doing so or be seriously or even fatally injured by any passing traffic.

Do not expose the child restraint system to direct sunlight. The child restraint system's metal parts, for example, could become very hot, and a child could be burned on these parts.

⚠ WARNING

Do not carry heavy or hard objects in the passenger compartment or cargo compartment unless they are firmly secured in place.

Unsecured or improperly positioned cargo increases a child's risk of injury in the event of

- strong braking maneuvers
- sudden changes of direction
- an accident

⚠ WARNING

Make sure the tailgate is closed when the engine is running and while driving. Among

other dangers, deadly carbon monoxide (CO) gases may enter vehicle interior resulting in unconsciousness and death.

- ❗ The tailgate swings upwards and to the rear when opened. Therefore, make sure that there is sufficient clearance above and behind the tailgate.

To open the tailgate completely, a minimum clearance of 7.20 ft (2.20 m) above the ground is necessary.

You can:

- open and close the tailgate manually from outside
- open and close the tailgate automatically from outside
- open and close the tailgate automatically from inside
- open the tailgate manually from inside
- limit the opening angle of the tailgate

Opening/closing from the outside**Opening**

- ▶ Press the  button on the SmartKey.

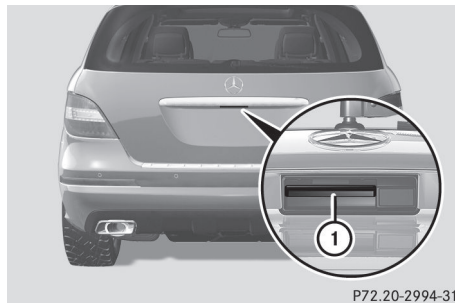



- ▶ Pull handle ①.
- ▶ Raise the tailgate.

Closing**⚠ WARNING**

To prevent possible personal injury, always keep hands and fingers away from the cargo

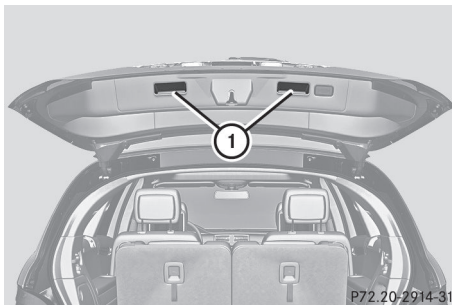
compartment opening when closing the tailgate. Be especially careful when small children are around.



- ▶ Pull the tailgate down using recess ①.
- ▶ Push the tailgate closed from outside the vehicle.
- ▶ If necessary, lock the vehicle with the  button on the SmartKey (> page 72) or with KEYLESS-GO (> page 73).
- ▶ **i** If a KEYLESS-GO key is detected in the cargo compartment, the tailgate will not lock.

Opening/closing automatically from outside

Important safety notes

WARNING

Make sure the tailgate is closed when the engine is running and while driving. Among other dangers, deadly carbon monoxide (CO) gases may enter vehicle interior resulting in unconsciousness and death.

- ▶ **!** The tailgate swings upwards and to the rear when opened. Therefore, make sure that there is sufficient clearance above and behind the tailgate.

To open the tailgate completely, a minimum clearance of 7.20 ft (2.20 m) above the ground is necessary.

Opening

You can open the tailgate automatically using the SmartKey or the handle in the tailgate.

- ▶ Press and hold the  button on the SmartKey until the tailgate opens.
- or
- ▶ When the tailgate is unlocked, pull the handle and let it go again immediately.

Closing

WARNING

Monitor the closing procedure carefully to make sure no one is in danger of being injured. To prevent possible personal injury, always keep hands and fingers away from the cargo compartment opening when closing the tailgate. Be especially careful when small children are around. To stop the closing procedure, do one of the following:

- Press or pull the remote tailgate opening/closing switch on the driver's door.
- Press the tailgate closing switch.
- Press the KEYLESS-GO locking/closing switch.
- Pull outside handle on the tailgate.
- When no SmartKey is inserted in the starter switch (vehicles with KEYLESS-GO: Make sure the vehicle's on-board electronics have status **0**): Press button  on the SmartKey.

You can close the tailgate automatically using the SmartKey, the closing button⁵ or the locking button⁶.

⁵ For vehicles with the EASY-PACK tailgate only.

⁶ For vehicles with the EASY-PACK tailgate and KEYLESS-GO only.

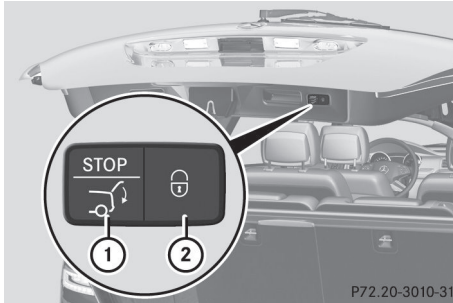

Closing button and locking button (example: vehicle with the EASY-PACK tailgate and KEYLESS-GO)

- ▶ **To close:** press closing button ① on the tailgate.
- or
- ▶ Press and hold the  button on the SmartKey until the tailgate closes.
- ▶ **To close and lock simultaneously:** Press locking button ② on the tailgate.

i The tailgate can only be opened and closed with the SmartKey if there is no SmartKey in the ignition lock.

If the tailgate touches an object while closing, the closing procedure is interrupted and the tailgate reopens.

i If you leave a KEYLESS-GO key in the cargo compartment, the tailgate will not lock.

The tailgate is not closed unless a KEYLESS-GO key is detected.

Opening/closing automatically from the inside

WARNING

Maintain sight of the area around the rear of the vehicle while operating the tailgate with the door-mounted remote tailgate switch. Monitor the opening procedure carefully to make sure no one is in danger of being injured.

To interrupt the opening procedure, press or pull the door-mounted remote tailgate switch.

When the SmartKey is not inserted in the starter switch (vehicles with KEYLESS-GO: Make sure the vehicle's on-board electronics have status **0**): Press button  on the SmartKey.

WARNING

Maintain sight of the area around the rear of the vehicle while operating the tailgate with the door-mounted remote tailgate switch. Monitor the closing procedure carefully to make sure no one is in danger of being injured.

To interrupt the closing procedure, press or pull the door-mounted remote tailgate switch.

WARNING

To prevent possible personal injury, always keep hands and fingers away from the cargo compartment opening when closing the tailgate. Be especially careful when small children are around.

WARNING

Make sure the tailgate is closed when the engine is running and while driving. Among other dangers, deadly carbon monoxide (CO) gases may enter vehicle interior resulting in unconsciousness and death.

You can open and close the tailgate from the driver's seat when the vehicle is stationary and unlocked.

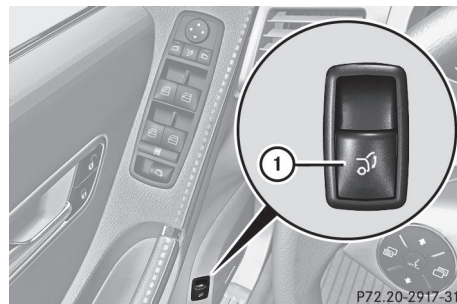

- ▶ **To open:** pull remote operating switch ① for the tailgate until the tailgate opens.
- ▶ **To close:** turn the SmartKey to position 1 or 2 in the ignition lock.
- ▶ Press remote operating switch for tailgate ① until the tailgate is closed.

If the tailgate comes into contact with an object, the closing procedure is interrupted and the tailgate reopens.

- ▶ **To interrupt the closing procedure:** push or pull remote operating switch for the tailgate ①.

Opening the tailgate from inside the vehicle

WARNING

Do not leave children unattended in the vehicle. Children could open the tailgate from the inside, which could result in an accident and/or serious personal injury.

- ❗ Always make sure there is sufficient space when opening.

You can unlock and open the tailgate from inside the vehicle.

The handle is on the lower part of the tailgate window on the right-hand side when viewed in the direction of travel.

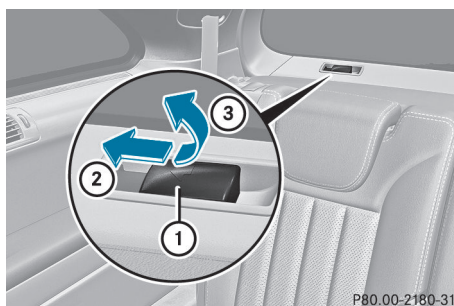

- ▶ Press handle ① in the direction of arrow ② as far as it will go and hold it there.
- ▶ From this position, pull handle ① in the direction of arrow ③ as far as it will go and hold it there.
- ▶ Swing the tailgate upwards.

- ❗ Vehicles with the EASY-PACK tailgate: If you do not open the tailgate after unlocking, it will lock again automatically after a few seconds.

Limiting the opening angle of the tailgate

Important safety notes

You can limit the opening angle of the tailgate in the top half of its opening range. This could be useful, for example, if there is insufficient space above the tailgate.

- ❗ Make sure there is sufficient clearance to open the tailgate fully when setting the opening angle. The tailgate could otherwise be damaged. Ideally, set the opening angle outside.

Activating

- ▶ **To open the tailgate:** pull the handle on the tailgate.
- ▶ **To stop the opening procedure at the desired position:** press the closing button (▷ page 83) in the tailgate or pull the handle on the outside of the tailgate again.
- ▶ **To store the position:** press and hold the closing button in the tailgate until you hear a short tone. The opening angle limiter is activated. The tailgate will now stop in the stored position when opening.

Deactivating

- ▶ Press and hold the closing button (▷ page 83) in the tailgate until you hear two short tones.

Side windows

Important safety notes

WARNING

When opening or closing the windows, make sure there is no danger of anyone being harmed by the opening/closing procedure.

The door windows are equipped with the express operation and automatic reversal function. If in express operation mode a door window encounters an obstruction that blocks its path, the automatic reversal function will stop the door window and open it slightly.

The door windows operate differently when the switch is pulled and held. See the "Closing when a door window is blocked" section in this chapter for details.

The closing of a door window can be immediately halted by releasing the switch or, if the switch was pulled past the resistance point and released, by either pressing or pulling the respective switch.

The closing of the hinged quarter windows can be immediately halted by pressing or pulling the switch.

If a window encounters an obstruction that blocks its path in a circumstance where you are closing the windows by pressing and holding button  on the SmartKey or by pressing and holding the lock button (vehicles with KEYLESS-GO) on an outside door handle, the automatic reversal function will not operate.

Activate the override switch when children are riding in the back seats of the vehicle. The children may otherwise injure themselves, e.g. by becoming trapped in the window opening.

WARNING

Do not keep any part of your body up against the window pane when opening a window. The downward motion of the pane may pull that part of your body down between the window pane and the door frame and trap it there. If there is a risk of entrapment, release the switch and pull it to close the window.

Opening and closing the side windows

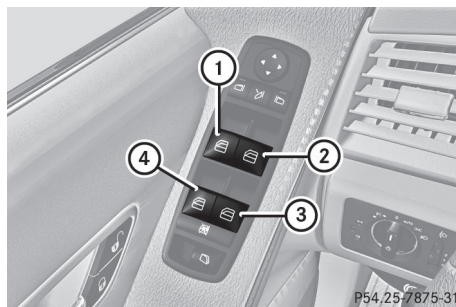

- ① Front left
- ② Front right
- ③ Rear right
- ④ Rear left

The switches for all side windows are located on the driver's door. There is also a switch on each door for the corresponding side window. The switches on the driver's door take precedence.

 The side windows cannot be operated from the rear when the override feature for the side windows is activated (▷ page 63).

- ▶ Turn the SmartKey to position **1** or **2** in the ignition lock.

▶ **To open:** press the corresponding switch.

▶ **To close:** pull the corresponding switch.

 If you press the switch beyond the point of resistance, an automatic opening/closing process is started in the corresponding direction. You can stop

automatic operation by operating the switch again.

- i** You can continue to operate the side windows after you switch off the engine or remove the SmartKey. This function is available for up to five minutes or until the driver's or front-passenger door is opened.

Opening and closing the hinged side windows

The hinged side windows are operated electrically from the from the driver's seat.

WARNING

Make sure that nobody can become trapped as you close the hinged side windows. If there is a risk of somebody becoming trapped, release the switch or push the switch again to reopen the side window.

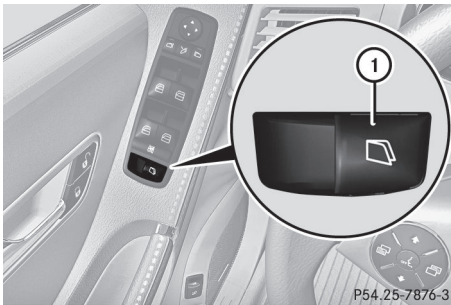

Door control panel

- ▶ Make sure that the SmartKey is in position **1** or **2** in the ignition lock.
- ▶ **To open fully:** press switch **1** and release.
- ▶ **To close fully:** pull switch **1** and release.
- ▶ **To stop the closing procedure:** press switch **1** again.
Both hinged side windows open fully.
- i** If the hinged side windows are blocked when closing, the closing procedure is terminated and the hinged side windows open again slightly.

- i** For safety reasons, the hinged side windows can only be opened again after four seconds.

Convenience opening feature



You can ventilate the vehicle before you start driving. To do this, the key is used to carry out the following functions simultaneously:

- unlock the vehicle
- open the side windows
- open the hinged side windows
- open the sliding sunroof or the panorama roof with power tilt/sliding panel and the roller sunblinds

- i** The convenience opening feature can only be operated using the SmartKey. The SmartKey must be close to the driver's door handle.

- ▶ Point the tip of the SmartKey at the driver's door handle.
- ▶ Press and hold the  button until the side windows and the sliding sunroof or the panorama roof with power tilt/sliding panel are in the desired position.

If the roller sunblinds of the panorama roof with power tilt/sliding panel are closed, the roller sunblinds are opened first.

- ▶ Press and hold the  button again until the panorama roof with power tilt/sliding panel is in the desired position.
- ▶ **To interrupt convenience opening:** release the  button.

Convenience closing

General information

When you lock the vehicle, you can simultaneously:



- close the side windows
- close the hinged side windows
- close the sliding sunroof or the panorama roof with power tilt/sliding panel

On vehicles with a panorama roof with power tilt/sliding panel, you can then close the roller sunblinds.

WARNING

When closing the door windows and the sliding sunroof or panorama roof with power tilt/sliding panel, make sure that there is no danger of anyone being harmed by the closing procedure.



If potential danger exists, proceed as follows:

- Release the  button to stop the closing procedure. To open, press and hold the  button. To continue the closing procedure after making sure that there is no danger of anyone being harmed by the closing procedure, press and hold the  button.

Vehicles with KEYLESS-GO:

- Release the lock button on the outside door handle to stop the closing procedure.
- Immediately pull on the same outside door handle and hold firmly. The door windows and the sliding sunroof or panorama roof with power tilt/sliding panel will open for as long as the door handle is held but the door is not opened.



Using the SmartKey

-  The SmartKey must be close to the driver's door handle.
- ▶ Point the tip of the SmartKey at the driver's door handle.
- ▶ Press and hold the  button until the side windows and the sliding sunroof or the

panorama roof with power tilt/sliding panel are fully closed.

- ▶ Make sure that all the side windows and the sliding sunroof or panorama roof with power tilt/sliding panel are closed.

On vehicles with a panorama roof with power tilt/sliding panel:

- ▶ Press and hold the  button again until the roller sunblinds of the panorama roof with power tilt/sliding panel close.
- ▶ **To interrupt convenience closing:** release the  button.

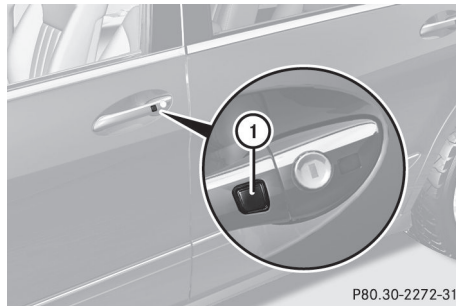

Using KEYLESS-GO

The KEYLESS-GO key must be outside the vehicle. All the doors must be closed.



- ▶ Keep locking button  on the door handle pressed until the side windows and the sliding sunroof or panorama roof with power tilt/sliding panel are fully closed.
- ▶ Make sure that all the side windows and the sliding sunroof or panorama roof with power tilt/sliding panel are closed.

On vehicles with a panorama roof with power tilt/sliding panel:

- ▶ Press and hold locking button  again until the roller sunblinds of the panorama roof with power tilt/sliding panel close.
- ▶ **To interrupt convenience closing:** release locking button  on the door handle.

Resetting the side windows

You must reset each side window if:

- the battery has been disconnected or has become discharged.
 - the side window opens again slightly after being closed fully.
 - the side window can no longer be fully opened or closed.
- ▶ Close all the doors.
 - ▶ Turn the SmartKey to position **1** or **2** in the ignition lock.
 - ▶ Pull the corresponding switch on the door control panel until the side window is completely closed. (▷ page 86)
 - ▶ Hold the switch for an additional second.

If the side window opens again slightly:

- ▶ Immediately pull the corresponding switch on the door control panel until the side window is completely closed (▷ page 86).
- ▶ Hold the switch for an additional second.
- ▶ If the corresponding side window remains closed after the button has been released, the side window has been reset correctly. If this is not the case, repeat the steps above again.

Problems with the side windows

Problem: a side window cannot be closed because it is blocked by objects, e.g. leaves in the window guide.

- ▶ Remove the objects.
- ▶ Close the side window.

Problem: a side window cannot be closed and you cannot see the cause.

WARNING

Closing the side windows with increased force or without the anti-entrapment feature could lead to serious or even fatal injury. Make sure that nobody can become trapped when closing the side windows.

If a side window is obstructed during closing and reopens again slightly:

- ▶ Immediately after the window blocks, pull the corresponding switch again until the side window has closed.
The side window is closed with increased force.

If a side window is obstructed again during closing and reopens again slightly:

- ▶ Immediately after the window blocks, pull the corresponding switch again until the side window has closed.
The side window is closed without the anti-entrapment feature.

WARNING

Pulling and holding the switch to close the door window immediately after it had been blocked two times will cause the door window to close without the anti-entrapment feature for as long as you hold the switch.

Sliding sunroof

Important safety notes

Your vehicle may be equipped with a sliding sunroof or a panorama roof with power tilt/sliding panel. In the following section, the term "sliding sunroof" refers to both types of sliding sunroof.

WARNING

When opening or closing the sliding sunroof, make sure that there is no danger of anyone being harmed by the opening/closing procedure.

The sliding sunroof is equipped with automatic operation and the anti-entrapment feature. If the movement of the sliding sunroof is blocked during the closing procedure, the sliding sunroof will stop and open slightly.

The sliding sunroof operates differently when the sliding sunroof switch is pressed and held. See the "Problems with the sliding sunroof" section for more details.

The opening/closing procedure of the sliding sunroof can be immediately halted by releasing the sliding sunroof switch or, if the sliding sunroof switch was moved past the resistance point and released, by moving the sliding sunroof switch in any direction.

WARNING

The sliding sunroof is made out of glass. In the event of an accident, the glass may shatter. This may result in an opening in the roof.

In a vehicle rollover, occupants not wearing their seat belts or not wearing them properly may be thrown out of the opening. Such an opening also presents a potential for injury for occupants wearing their seat belts properly, as entire body parts or portions of them may protrude from the passenger compartment.

! Only open the sliding sunroof if it is free of snow and ice. Otherwise, malfunctions may occur.

Do not allow anything to protrude from the sliding sunroof. Otherwise, the seals could be damaged.

! The weather can change abruptly. It could start to rain or snow. Make sure that the sliding sunroof is closed when you leave the vehicle. The vehicle electronics can be damaged if water enters the vehicle interior.

i Resonance noises can occur in addition to the usual airflow noises when the sliding sunroof is open. They are caused by minor pressure fluctuations in the vehicle interior. Change the position of the sliding sunroof or open a side window slightly to reduce or eliminate these noises.

Operating the sliding sunroof

Opening and closing

i You can continue to operate the sliding sunroof after switching off the engine or removing the SmartKey from the ignition

lock. This function is available for up to five minutes or until the driver's or front-passenger door is opened.

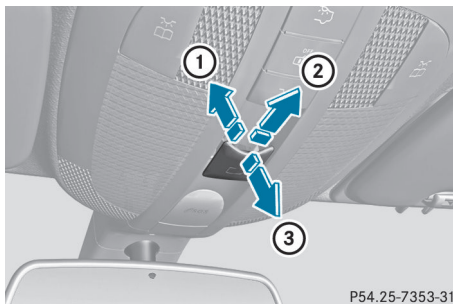

Overhead control panel

- ① To raise
- ② To open
- ③ To close/lower

▶ Turn the SmartKey to position **1** or **2** in the ignition lock.

▶ Press or pull the  switch in the corresponding direction.

i If you press the  switch beyond the point of resistance, an automatic opening/closing process is started in the corresponding direction. You can stop automatic operation by operating the switch again.

The sun protection cover automatically opens along with the sliding sunroof. You can open or close the sun protection cover manually when the sliding sunroof is raised or closed.

Resetting

Reset the sliding sunroof if it does not move smoothly, or if the battery has been disconnected or has become discharged.

▶ Remove the SmartKey from the ignition lock or select position **0** (KEYLESS-GO).

▶ Remove the fuse for the sliding sunroof from the fuse box. To find out where the fuse is located, refer to the fuse allocation chart in the vehicle tool kit (▷ page 296).

▶ Reinsert the fuse.

- ▶ Turn the SmartKey to position **2** in the ignition lock.
- ▶ Raise the sliding sunroof fully at the rear (▷ page 90).
- ▶ Keep the switch pressed for another second.
- ▶ Make sure that the sliding sunroof can be fully opened and closed again (▷ page 90).
- ▶ If this is not the case, repeat the steps above again.

! If the sliding sunroof still cannot be opened or closed fully after resetting, contact a qualified specialist workshop.

Operating the panorama roof with power tilt/sliding panel

Opening and closing

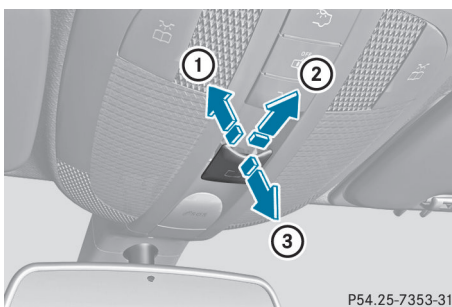

Overhead control panel

- ① To raise
- ② To open
- ③ To close/lower

The panorama roof with power tilt/sliding panel can only be operated when the roller sunblind is open.

- ▶ Turn the SmartKey to position **1** or **2** in the ignition lock.
- ▶ Push or pull the switch in the corresponding direction.
- i** When opening the panorama roof with power tilt/sliding panel, you can initiate the automatic opening process. To do so, press the switch briefly beyond the point of

resistance in the direction of arrow ②. By pressing again, the automatic opening process can be stopped.

The automatic opening feature is available only when the panorama roof with power tilt/sliding panel is closed.

Operating the panorama roof with power tilt/sliding panel roller sunblinds

General notes

The roller sunblinds shield the vehicle interior from sunlight. The two roller sunblinds can only be opened and closed together when the panorama roof with power tilt/sliding panel is closed.

! WARNING

When extending the roller sunblinds, make sure no one is in danger of being injured by the extending procedure. The extending of the roller sunblinds can be immediately halted by releasing the switch.

Opening and closing

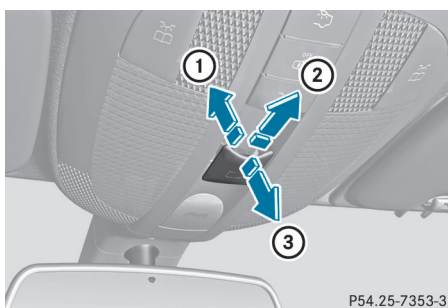

Overhead control panel

- ① To open
- ② To close
- ③ To lower



- ▶ Turn the SmartKey to position **1** or **2** in the ignition lock.
- ▶ Press or pull the switch in the corresponding direction.

- i** When opening the roller sunblinds, you can initiate an automatic opening process. To do so, press the  switch briefly beyond the point of resistance in the direction of arrow ②. Operate the switch again to stop the automatic opening process.

Resetting the panorama roof with power tilt/sliding panel and the roller sunblinds

Reset the panorama roof with power tilt/sliding panel and the roller sunblinds if the panorama roof with power tilt/sliding panel or the roller sunblinds do not move smoothly.

The panorama roof with power tilt/sliding panel and the roller sunblinds must also be reset if the battery was disconnected or discharged.

- ▶ Remove the SmartKey from the ignition lock or select position **0** (KEYLESS-GO).
- ▶ Remove the fuse for the panorama roof with power tilt/sliding panel from the fuse box. To find out where the fuse is located, refer to the fuse allocation chart in the vehicle tool kit (▷ page 296).
- ▶ Reinsert the fuse.
- ▶ Turn the SmartKey to position **1** or **2** in the ignition lock.
- ▶ Close the roller sunblinds fully (▷ page 91).
- ▶ Keep the  switch pressed for another second.
- ▶ Open the roller sunblinds fully (▷ page 91).
- ▶ Keep the  switch pulled for an additional second.
- ▶ Close the panorama roof with power tilt/sliding panel fully (▷ page 91).
- ▶ Keep the  switch pressed for another second.
- ▶ Make sure that the panorama roof with power tilt/sliding panel and the roller

sunblinds can be fully opened again (▷ page 91).

- ▶ If this is not the case, repeat the steps above again.

- !** If the panorama roof with power tilt/sliding panel and the roller sunblind cannot be fully opened or closed after resetting, contact a qualified specialist workshop.

Problems with the sliding sunroof

Your vehicle may be equipped with a sliding sunroof or a panorama roof with power tilt/sliding panel. In the following section, the term "sliding sunroof" refers to both types of sliding sunroof.

Problem: the sunroof cannot be closed and you cannot see the cause.

WARNING

You could be severely or even fatally injured when closing the sliding sunroof with increased closing force or if the anti-entrapment feature is deactivated. Make sure that nobody can become trapped when closing the sliding sunroof.

If the sliding sunroof is obstructed during closing and reopens again slightly:

- ▶ Immediately after the sliding sunroof blocks, pull the  switch in the overhead control panel down to the point of resistance and hold it until the sliding sunroof is closed.
- The sliding sunroof is closed with increased force.

If the sliding sunroof is obstructed again during closing and reopens again slightly:

- ▶ Immediately after the sliding sunroof blocks, pull the  switch in the overhead control panel down to the point of resistance and hold it until the sliding sunroof is closed.
- The sliding sunroof is closed without the anti-entrapment feature.

 **WARNING**

Pressing and holding the sliding sunroof switch to close the sliding sunroof immediately after it had been blocked two times will cause the sliding sunroof to close without the anti-entrapment feature for as long as you hold the switch.

- !** If the sliding sunroof still cannot be opened or closed due to a malfunction, contact a qualified specialist workshop, e.g. an authorized Mercedes-Benz Center.

Useful information	96
Correct driver's seat position	96
Seats	97
Steering wheel	107
Mirrors	109
Memory functions	112

Useful information

- i** This Operator's Manual describes all models and all standard and optional equipment of your vehicle available at the time of publication of the Operator's Manual. Country-specific differences are possible. Please note that your vehicle may not be equipped with all features described. This also applies to safety-related systems and functions.
- i** Please read the information on qualified specialist workshops (▷ page 24).

Correct driver's seat position

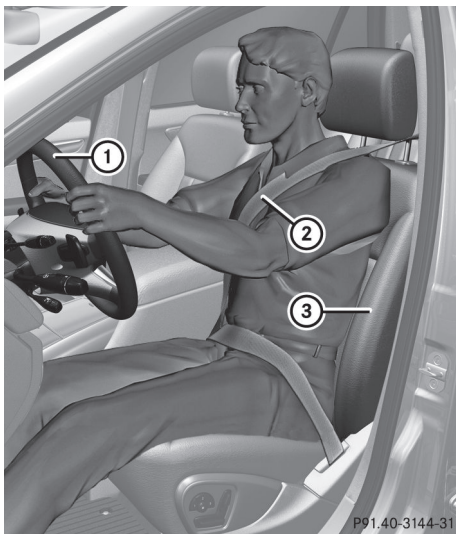

Observe the safety guidelines on seat adjustment (▷ page 97).

- ▶ Check whether you have adjusted seat ③ properly.
Electrical seat adjustment (▷ page 98)
When adjusting the seat, make sure:
 - you are as far away from the driver's air bag as possible.
 - you are sitting in a normal upright position.

- you can fasten the seat belt properly.
- you have moved the backrest to an almost vertical position.
- you have set the seat cushion angle so that your thighs are gently supported.
- you can depress the pedals properly.

- ▶ Check whether the head restraint is adjusted properly (▷ page 99).

When doing so, make sure that you have adjusted the head restraint so that the back of your head is supported at eye level by the center of the head restraint.

Observe the safety guidelines on steering wheel adjustment (▷ page 107).

- ▶ Check whether steering wheel ① is adjusted properly.

Adjusting the steering wheel manually (▷ page 107)

Adjusting the steering wheel electrically (▷ page 108)

When adjusting the steering wheel, make sure:

- you can hold the steering wheel with your arms slightly bent.
- you can move your legs freely.
- you can see all the displays in the instrument cluster clearly.

Observe the safety guidelines for seat belts (▷ page 51).

- ▶ Check whether you have fastened seat belt ② properly (▷ page 53).

The seat belt should:

- fit snugly across your body
 - be routed across the middle of your shoulder
 - be routed in your pelvic area across the hip joints
- ▶ Before starting off, adjust the rear-view mirror and the exterior mirrors

(▷ page 110) in such a way that you have a good view of road and traffic conditions.

- ▶ **Vehicles with a memory function:** save the seat, steering wheel and exterior mirror settings (▷ page 112).

Seats

Important safety notes

WARNING

In order to avoid possible loss of vehicle control, all seat, head restraint, steering wheel and rear view mirror adjustments, as well as fastening of seat belts, must be done before setting the vehicle in motion.

WARNING

Do not adjust the driver's seat while driving. Adjusting the seat while driving could cause the driver to lose control of the vehicle.

Never travel in a moving vehicle with the seat backrest in an excessively reclined position as this can be dangerous. You could slide under the seat belt in a collision. If you slide under it, the seat belt would apply force at the abdomen or neck. This could cause serious or fatal injuries. The seat backrest and seat belts provide the best restraint when the wearer is in a position that is as upright as possible and seat belts are properly positioned on the body.

WARNING

Your seat belt must be adjusted so that you can correctly fasten your seat belt.

Observe the following points:

- adjust the seat backrest until your arms are slightly angled when holding the steering wheel.
- adjust the seat to a comfortable seating position that still allows you to reach the accelerator/brake pedal safely. The position should be as far back as possible

with the driver still able to operate the controls properly.

- adjust the head restraint so that it is as close to the head as possible and the center of the head restraint supports the back of the head at eye level.
- never place hands under the seat or near any moving parts while a seat is being adjusted.

Failure to do so could result in an accident and/or serious personal injury.

WARNING

The electrically adjustable seats can be operated at any time. Therefore, do not leave children unattended in the vehicle, or with access to an unlocked vehicle. A child's unsupervised access to a vehicle could result in an accident and/or serious personal injury.

WARNING

According to accident statistics, children are safer when properly restrained in the rear seating positions than in the front seating position. Thus, we strongly recommend that children be placed in the rear seats whenever possible. Regardless of seating position, children 12 years old and under must be seated and properly secured in an appropriately sized infant restraint, toddler restraint, or booster seat recommended for the size and weight of the child. For additional information, see "Children in the vehicle".

A child's risk of serious or fatal injuries is significantly increased if the child restraints are not properly secured in the vehicle and/or the child is not properly secured in the child restraint.

WARNING

For your protection, drive only with properly positioned head restraints.

Adjust the head restraint so that it is as close to the head as possible and the center of the head restraint supports the back of the head at eye level. This will reduce the potential for

injury to the head and neck in the event of an accident or similar situation.

Do not drive the vehicle without the seat head restraints. Head restraints are intended to help reduce injuries during an accident.

! To avoid damage to the seats and the seat heating, observe the following information:

- keep liquids from spilling on the seats. If liquid is spilled on the seats, dry them as soon as possible.
- if the seat covers are damp or wet, do not switch on the seat heating. The seat heating should also not be used to dry the seats.
- clean the seat covers as recommended; see the "Interior care" section.
- do not transport heavy loads on the seats. Do not place sharp objects on the seat cushions, e.g. knives, nails or tools. The seats should only be occupied by passengers, if possible.
- when the seat heating is in operation, do not cover the seats with insulating materials, e.g. blankets, coats, bags, seat covers, child seats or booster seats.

! When you move the seats, make sure that there are no objects in the footwell or behind the seats. Otherwise, you could damage the seats and the objects.

! When the outer seats in the second row are folded down, the front seats must not be in their rearmost position. The front seats and the outer seats in the second row could otherwise be damaged.

! Make sure that the sun visor is folded up before adjusting the backrest and head restraint height. The head restraint and sun visor could otherwise collide when the head restraint is fully extended.

i The rear-compartment head restraints can be removed (▷ page 100).

Please contact an authorized Mercedes-Benz Center for more information.

i Other topics:

- Cargo compartment enlargement (folding the second and third row of seats forward) (▷ page 253)

Adjusting the seats

i Vehicles without Memory function: the seats can be adjusted within three minutes of a front door being opened.

The time period starts over again if, within these three minutes, you:

- open or close a front door
- insert the SmartKey into the ignition lock or remove it from the ignition lock
- switch the ignition on or off

If the SmartKey is in position **2** in the ignition lock, the seats can be adjusted at any time.

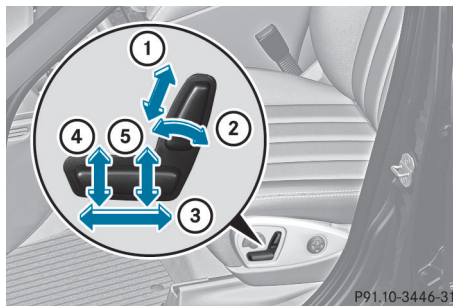

- ① Head restraint height⁷
- ② Backrest angle
- ③ Seat fore-and-aft adjustment
- ④ Seat cushion angle
- ⑤ Seat height

i Vehicles with Memory function: If PRE-SAFE[®] has been activated, the front-passenger seat is moved to a better position if it was previously set unfavorably.

⁷ Only for vehicles with memory function.

- i** You can store the seat settings using the memory function (▷ page 112).

Adjusting the head restraints

Adjusting the head restraints manually

Adjusting the head restraint height⁸

- !** The head restraints must only be removed at a qualified specialist workshop. Mercedes-Benz recommends that you use a Mercedes-Benz Center for this purpose.

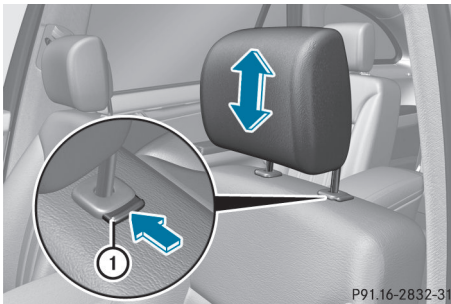

- ▶ If the head restraint is fully lowered, it is necessary to press release catch ①.
- ▶ **To raise:** pull the head restraint up to the desired position.
- ▶ **To lower:** press release catch ① in the direction of the arrow and push the head restraint down to the desired position.

Adjusting the angle of the head restraints

⚠ WARNING

Vehicles with Rear Seat Entertainment System: When adjusting the head restraint, make sure your fingers do not become caught between the head restraint cushion and the monitor. Failing to do so may lead to injury.



- ▶ Push or pull the lower edge of the head restraint in the direction of the arrow.

Adjusting the head restraint height electrically⁹

- ▶ **To adjust the head restraint height:** slide the switch for head restraint adjustment (▷ page 98) up or down in the direction of the arrow.

Adjusting luxury head restraints

⚠ WARNING

When folding back the side cushions, never reach between the side cushion and the mounting post. You could otherwise be trapped.

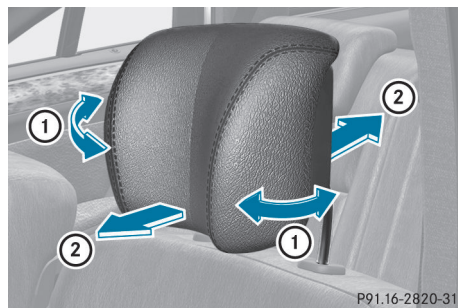

- ▶ **To adjust the side bolsters of the head restraint:** push or pull right and/or left-

⁸ For vehicles without memory function only.

⁹ For vehicles with memory function only.

hand side bolster ① into the desired position.

- ▶ **To adjust the angle of the head restraint:** push or pull the head restraint in the direction of arrow ②.

Rear seat head restraints

WARNING

For safety reasons, always drive with the rear head restraints in the upright position when the rear seats are occupied.

Keep the area around head restraints clear of articles (e.g. clothing) to not obstruct the folding operation of the head restraints.

WARNING

For your protection, drive only with properly positioned head restraints.

Adjust the head restraint in such a way that it is as close to the head as possible and the center of the head restraint supports the back of the head at eye level. This will reduce the potential for injury to the head and neck in the event of an accident or similar situation.

With a rear seat occupied, make sure to move the respective head restraint up from the lowest non-use position and have the occupant adjust the head restraint properly. Do not drive the vehicle without the seat head restraints installed when the rear seats are occupied. Head restraints are intended to help reduce injuries during an accident.

Adjusting the head restraint height (second and third row of seats)

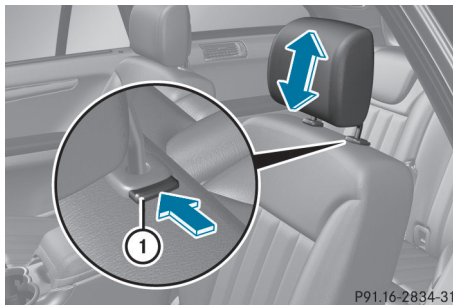

Outer seat head restraints in the second row of seats

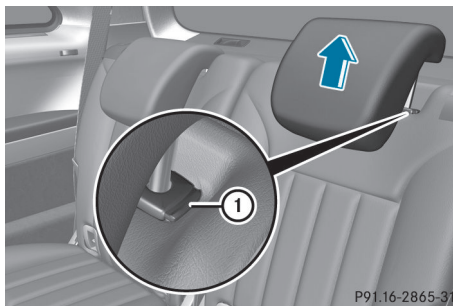

Outer seat head restraints in the third row of seats

- ▶ If the head restraint is fully lowered, it is necessary to press release catch ①.
- ▶ **To raise:** pull the head restraint up to the desired position.
- ▶ **To lower:** press release catch ① and push the head restraint down until it is in the desired position.

Removing and installing rear head restraints

WARNING

Occupants should only travel sitting on seats which have the head restraints installed. In the event of an accident, this reduces the risk of injury for passengers seated in the rear compartment.

If you wish to remove the head restraints from the outer seats in the second row of seats,

you must move the respective seat as far back as possible (▷ page 101). Then, fold the seat backrest forwards.

You can remove the head restraints in the second row of seats (center seat and outer seats) and the head restraints in the third row of seats in the same way.

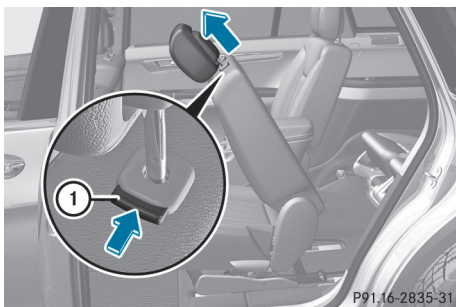

Removing the head restraints from the outer seats in the second row of seats

- ▶ **To remove:** pull the head restraint up to the stop.
 - ▶ Press release catch ① and pull the head restraint out of the guides.
 - ▶ **To re-install:** place the head restraint in the guides of the backrest.
- i** For the outer seat head restraints in the second row of seats, the notches on the guide rod must be on the left-hand side when viewed in the direction of travel.
- ▶ Push the head restraint down until you hear it engage in position.

Adjusting the seats in the 2nd and 3rd rows

Important safety notes

⚠ WARNING

Never travel in a moving vehicle with the seat backrest in an excessively reclined position as this can be dangerous. You could slide under the seat belt in a collision. If you slide under it, the seat belt would apply force at the abdomen or neck. This could cause serious or

fatal injuries. The seat backrest and seat belt provide the best restraint when the wearer is in a position that is as upright as possible and the seat belt is properly positioned on the body.

Your seat belt must be adjusted so that you can correctly fasten your seat belt.

Never place hands under the seat or near any moving parts while a seat is being adjusted.

After adjusting the seat, always ensure that the seat and the backrest are correctly engaged. The backrest must be in an upright position.

An outer seat in the second row is only locked correctly if lock verification indicator ① is folded in and red marking ② is just visible.

If the seat and backrest are not correctly latched, the seat could move forward and the backrest could fold down. While braking, changing direction, or in an accident, you could slide under the seat belt. The child seat would no longer be correctly supported or correctly positioned and would no longer carry out its intended function. This could cause serious or fatal injuries.

Seat locking display

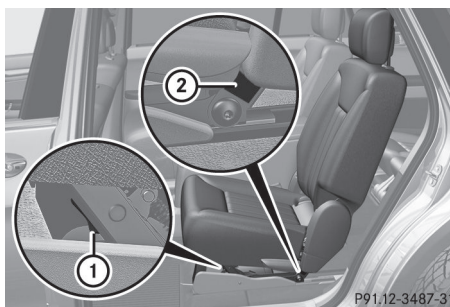

Seat locked

When the seat is locked, lock verification indicator ① is folded in and indicator area ② is barely visible.

Adjusting seat fore-and-aft adjustment (outer seats in the 2nd row of seats)

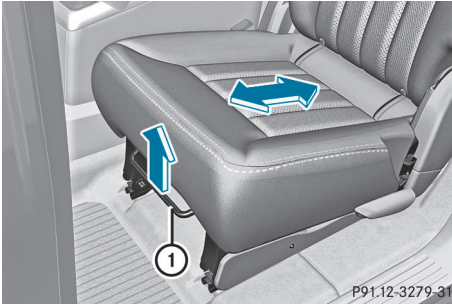

- ▶ Pull lever ① in the direction of the arrow to the pressure point and hold it in this position.
- ▶ Slide the seat forwards or backwards to the desired position.
- ▶ Release lever ①.
The seat engages audibly.

Adjusting the backrest angle

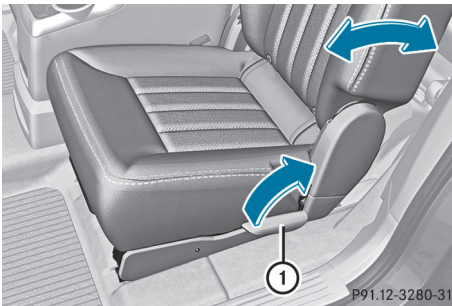

Outer seats, 2nd row

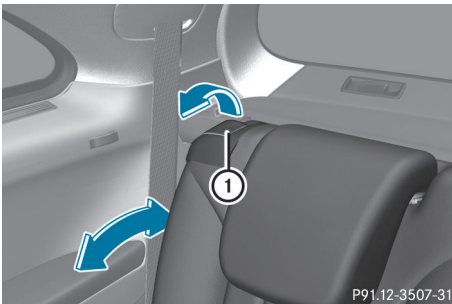

3rd row of seats

- ▶ Pull lever ① in the direction of the arrow to the pressure point and hold it in this position.
- ▶ Press your back lightly against the backrest to tilt it towards the rear.

or

- ▶ Relieve the pressure on the backrest to allow it to fold forwards.
- ▶ Release lever ① once the backrest is in the desired position.
- ▶ Lean back firmly against the backrest to ensure that it is engaged.

Adjusting the armrest (2nd row of seats)

6-seat vehicles

You can fold the armrests in the 2nd row of seats up, e.g. when loading the vehicle, and adjust their height.

- ▶ **To fold up:** fold the armrest up until it engages in the vertical position.
- ▶ **To adjust the height:** gently push the engaged armrest backwards to release it.
- ▶ First fold the armrest all the way down to its lowest position and then back up to the desired position until it engages.

i If you want to lower the armrest, you must first fold it up. Then adjust the height as described above.

7-seat vehicles

The backrest of the center seat in the 2nd row can be used as an armrest.

⚠ WARNING

The folded second-row middle seat is intended to serve as an armrest only. Do not fold the second-row middle seat and allow occupants to use the folded second-row middle seat as a footrest while driving. All vehicle occupants must keep both feet on the floor in front of their seat. Otherwise, occupants could slide under the seat belt in a collision. If occupants slide under it, the belt

would apply force at the abdomen or neck. That could cause serious or even fatal injuries. Do not fold the second-row middle seat and allow occupants to use the folded second-row middle seat as a table while driving. Objects placed on the folded second-row middle seat may move freely during braking, vehicle maneuvers, or an accident and be thrown around in the vehicle interior. Objects thrown around in the vehicle interior may cause an accident and/or serious personal injury.

- ▶ **To put the backrest into the armrest position:** move the head restraint of the center seat to the lowest position (▷ page 100).

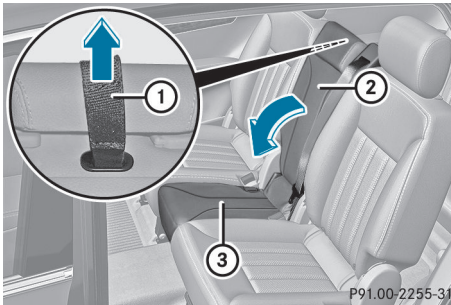

- ▶ Pull release loop ① in the direction of the arrow and hold it in this position.
- ▶ Fold backrest ② forwards until it is resting on seat cushion ③ in the armrest position.

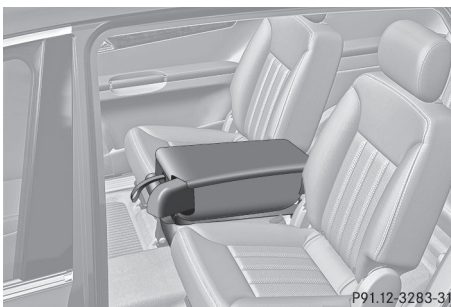

Armrest position

- ▶ **To move the backrest to its upright position:** pull release loop ① in the

direction of the arrow and hold it in this position.

- ▶ Fold backrest ② backwards until you hear it engage.

EASY-ENTRY/EXIT feature (3rd row of seats)

Important safety notes

⚠ WARNING

To help avoid personal injury, the second-row seat backrests must be properly locked either in the upright position or, when using the expanded cargo volume, in the fully folded position while the vehicle is in motion.

❗ Seven-seat vehicles:

Do not use the EASY-ENTRY/EXIT feature on the left outer seat when the middle seat in the second row of seats is in the armrest position. You could otherwise damage the seats.

❗ Vehicles with a Rear Seat Entertainment System:

The screen of the Rear Seat Entertainment System may be damaged if the head restraint on the respective outer seat in the second row of seats is extended significantly when using the EASY-ENTRY/EXIT feature.

Move the head restraint to the lowest position or carefully guide the seat backrest forwards to prevent damage.

For further information on folding the seats in the 3rd row forwards, see (▷ page 253), and for information on enlarging the cargo compartment (folding the seats of the 2nd and 3rd rows forwards), see (▷ page 253).

EASY-ENTRY feature

The release handle for the EASY-ENTRY feature is located on the entry side on the back of each outer seat in the 2nd row of seats.

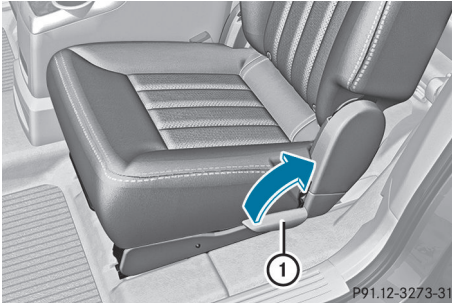

- ▶ Pull release handle ① in the direction of the arrow to the pressure point and hold it in this position. The backrest folds forwards.
- ▶ Slide the seat in the 2nd row of seats forwards to the stop.

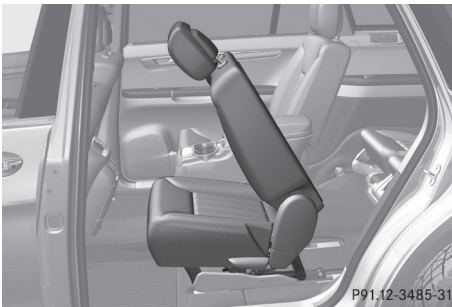

Entry position

EASY-EXIT feature

The release loop for the EASY-EXIT feature is located at the bottom on the back of each outer seat in the 2nd row of seats.

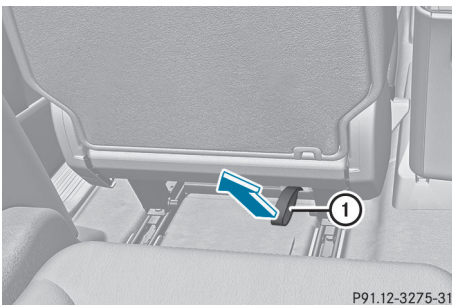

- ▶ Pull release loop ① in the direction of the arrow and hold it in this position. The backrest folds forwards.
- ▶ Slide the seat in the 2nd row of seats forwards to the stop.



Exit position

Moving the outer seats in the 2nd row back to the normal position

⚠ WARNING

When occupants have entered or exited the vehicle using the easy-entry/exit feature, before driving off make sure

- the outboard second-row seats are properly locked
- the seat backrests of the outboard second-row seats are in an upright position and are properly locked

An outboard second-row seat is properly locked only when lock status indicator ① is in hinged position and red marking ② is barely visible.

If a seat and seat backrest are not properly locked, the seat could move forward and the seat backrest could fold. You could slide under the seat belt during braking, vehicle maneuvers, or in an accident. If you slide under it, the seat belt would apply force at the abdomen or neck. That could cause serious or even fatal injuries.

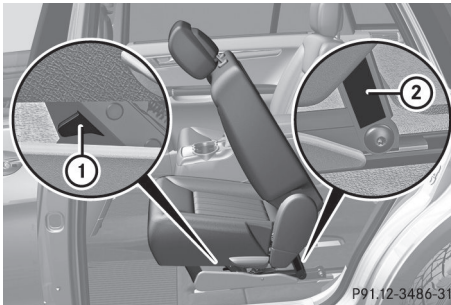

Seat unlocked

When the seat is unlocked, lock verification indicator ① is folded out and indicator area ② is clearly visible.

- ▶ **To lock the seat:** fold back the backrest until you hear it engage.

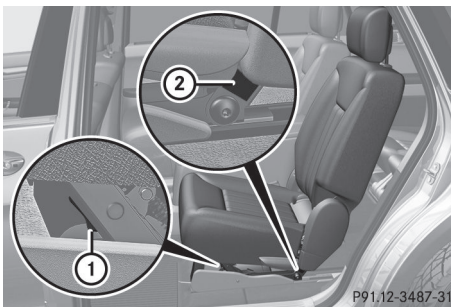

Seat locked

When the seat is locked, lock verification indicator ① is folded in and indicator area ② is barely visible.

Adjusting the multicontour seat

You can adjust the contour of the front seats individually so as to provide optimum support for your back and sides.

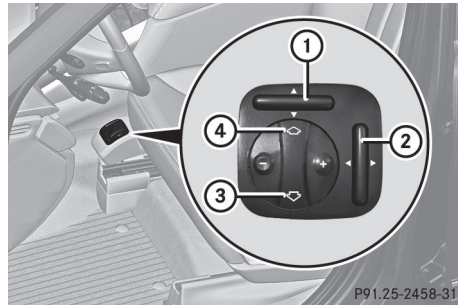

- ▶ Make sure that the SmartKey is in position 2 in the ignition lock.
- ▶ Use switch ① to move the thigh cushion into the desired position.
- ▶ Press the $\boxed{+}$ or $\boxed{-}$ button to adjust the contour of the backrest to suit your back.
- ▶ Press button ④ to move the point of greatest backrest curvature downwards to the lumbar region and press button ③ to move it upwards to the upper back region.
- ▶ Use button ② to adjust the side bolsters for optimum lateral support.

Adjusting the four-way lumbar support

You can adjust the contour of the driver's seat backrests individually to provide optimum support for your back.

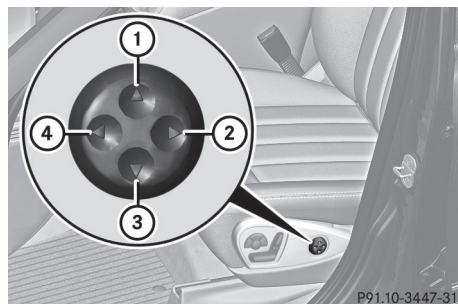

- ① To raise the backrest contour
- ② To soften the backrest contour
- ③ To lower the backrest contour
- ④ To harden the backrest contour

Switching the seat heating on/off

Switching on/off

The three red indicator lamps in the button indicate the heating level you have selected.

i If the battery voltage is too low, the seat heating may switch off.

One or more of the indicator lamps in the seat heating button are flashing.

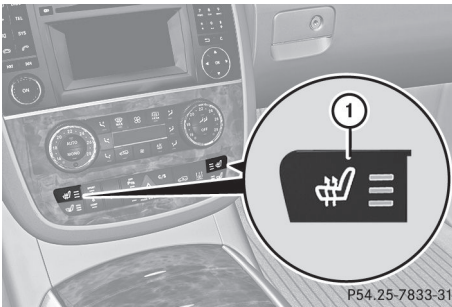

P54.25-7833-31

Driver's and front-passenger seat

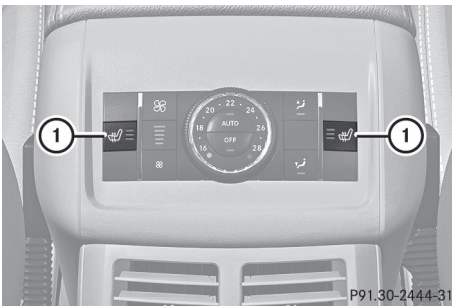

P91.30-2444-31

Rear seats

The system automatically switches down from level **3** to level **2** after approximately five minutes.

The system automatically switches down from level **2** to level **1** after approximately ten minutes.

The system automatically switches off approximately 20 minutes after it is set to level **1**.

- ▶ Make sure that the SmartKey is in position **2** in the ignition lock.
- ▶ **To switch on:** press button **1** repeatedly until the desired heating level is set.
- ▶ **To switch off:** press button **1** repeatedly until all the indicator lamps go out.

Problems with the seat heating

If one or all of the indicator lamps in the seat heating button are flashing, the seat heating has switched off automatically. The vehicle's electrical system voltage is too low because too many electrical consumers are switched on.

- ▶ Switch off electrical consumers which you do not need, such as the rear window defroster or interior lighting. Once the battery is sufficiently charged, the seat heating will switch back on automatically.

Switching the seat ventilation on/off

Switching on/off

The three blue indicator lamps in the buttons indicate the ventilation level you have selected.

i If the battery voltage is too low, the seat ventilation may switch off.



P91.30-2443-31

- ▶ Make sure that the SmartKey is in position **2** in the ignition lock.
- ▶ **To switch on:** press button **①** repeatedly until the desired ventilation level is set.
- i** You can open the side windows and the sliding sunroof using the "Convenience opening" feature (▶ page 87). The seat ventilation of the driver's seat automatically switches to the highest level.
- ▶ **To switch off:** press button **①** repeatedly until all the indicator lamps go out.

Problems with the seat ventilation

If one or all of the indicator lamps in the seat ventilation button are flashing, the seat ventilation has switched off automatically. The vehicle's electrical system voltage is too low because too many electrical consumers are switched on.

- ▶ Switch off electrical consumers which you do not need, such as the rear window defroster or interior lighting. Once the battery is sufficiently charged, the seat ventilation will switch back on automatically.

Steering wheel

Important safety notes

WARNING

Do not adjust the steering wheel while driving. Adjusting the steering wheel while driving, or driving without the steering wheel adjustment feature locked could cause the driver to lose control of the vehicle.

The electrical steering wheel adjustment feature can be operated at any time. Therefore, do not leave children unattended in the vehicle, or with access to an unlocked vehicle. A child's unsupervised access to a vehicle could result in an accident and/or serious personal injury.

Adjusting the steering wheel manually

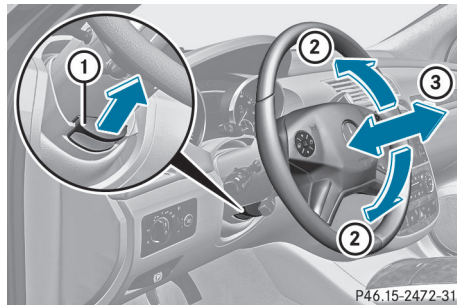

- ① Release handle
 - ② To adjust the steering wheel height
 - ③ To adjust the steering wheel position (fore-and-aft adjustment)
- ▶ Pull release handle **①** out completely. The steering column is unlocked.
 - ▶ Adjust the steering wheel to the desired position.
 - ▶ Push release handle **①** in completely until it engages fully. The steering column is locked.
 - ▶ Check if the steering column is locked. When doing so, try to push the steering wheel up or down or try to move it in the fore-and-aft direction.

Adjusting the steering wheel electrically

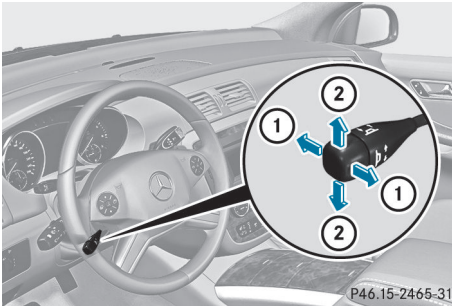

- ① To adjust the steering wheel position (fore-and-aft adjustment)
- ② To adjust the steering wheel height

i Other topics:

- EASY-ENTRY/EXIT feature (▷ page 108)
- storing settings (▷ page 112)

Steering wheel heating

Switching on/off

The steering-wheel heating heats the leather areas of the steering wheel.

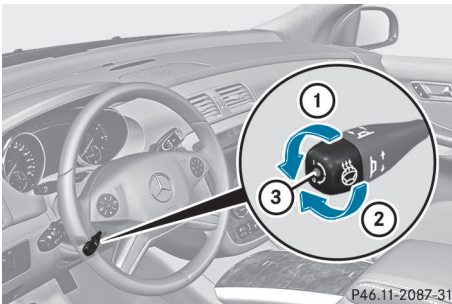

- ▶ Make sure that the SmartKey is in position 2 in the ignition lock.
- ▶ **To switch on/off:** turn the lever in the direction of arrow ① or ②. Indicator lamp ③ lights up or goes out.

i The steering wheel heating may switch off temporarily if:

- the temperature of the vehicle interior is above 86 °F (30 °C).
- the temperature of the steering wheel is above 95 °F (35 °C).

Indicator lamp ③ remains on.

Vehicles without KEYLESS-GO: when you remove the key from the ignition lock, the steering wheel heating is deactivated.

Vehicles with KEYLESS-GO: when you switch off the ignition and open the driver's door, the steering wheel heating is deactivated.

Problems with the steering wheel heating

If steering wheel heating indicator lamp ③ is flashing, the steering wheel heating has switched off automatically. The vehicle's electrical system voltage is too low because too many electrical consumers are switched on.

- ▶ Switch off electrical consumers which you do not need, such as the rear window defroster or interior lighting. Once the battery is sufficiently charged, the steering wheel heating will switch back on automatically.

EASY-ENTRY/EXIT system

Important safety notes

The EASY-ENTRY/EXIT feature makes getting in and out of your vehicle easier.

You can activate and deactivate the EASY-ENTRY/EXIT feature in the on-board computer (▷ page 209).

⚠ WARNING

You must make sure no one can become trapped or injured by the moving steering wheel when the easy-entry/exit feature is activated.

To stop steering wheel movement do one of the following:

- Move steering wheel adjustment stalk.
- Press one of the memory position buttons.
- Press memory button **M**.

Do not leave children unattended in the vehicle, or with access to an unlocked vehicle. Children could open the driver's door and unintentionally activate the easy-entry/exit feature, which could result in an accident and/or serious personal injury.

WARNING

Let the system complete the adjustment procedure before setting the vehicle in motion. All steering wheel adjustment must be completed before setting the vehicle in motion. Driving off with the steering wheel still adjusting could cause the driver to lose control of the vehicle.

Position of the steering wheel when the EASY-ENTRY/EXIT feature is active

The steering wheel swings upwards when you:

- remove the SmartKey from the ignition lock
- open the driver's door and KEYLESS-GO is in position **1**
- open the driver's door and the SmartKey is in position **0** or **1** in the ignition lock

i The steering wheel only moves upwards if it has not already reached the upper end stop.

Position of the steering wheel for driving

The steering wheel is moved to the last selected position when:

- the driver's door is closed.
- you insert the SmartKey into the ignition lock.

or

- you press the Start/Stop button once on vehicles with KEYLESS-GO.

When you close the driver's door with the ignition switched on, the steering wheel is also automatically moved to the previously set position.

The last position of the steering wheel is stored when you switch off the ignition or when you store the setting with the memory function (▷ page 112).

Crash-responsive EASY-EXIT feature

If the crash-responsive EASY-EXIT feature is triggered in an accident, the steering column will move upwards when the driver's door is opened. This occurs irrespective of the position of the SmartKey in the ignition lock. This makes it easier to exit the vehicle and rescue the occupants.

The crash-responsive EASY-EXIT feature is only operational if the EASY-EXIT/ENTRY feature is activated in the on-board computer.

Mirrors

Rear-view mirror

Rear-view mirror (manual anti-glare)

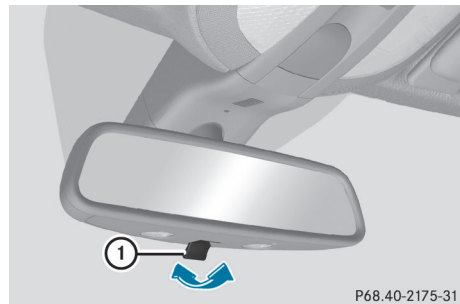

- ▶ **anti-glare mode:** flick anti-glare switch ① forwards or back.

P68.40-2175-31

Exterior mirrors

Adjusting the exterior mirrors

WARNING

Exercise care when using the passenger-side exterior rear view mirror. The mirror surface is convex (outwardly curved surface for a wider field of view). Objects in mirror are closer than they appear. Check your interior rear view mirror and glance over your shoulder before changing lanes.

The exterior mirrors are automatically heated if the rear window defroster is switched on and the outside temperature is low.

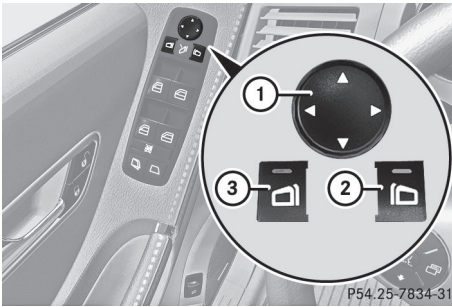

- ▶ Make sure that the SmartKey is in position **1** or **2** in the ignition lock.
- ▶ Press button **2** for the right-hand exterior mirror or button **3** for the left-hand exterior mirror.
The indicator lamp in the corresponding button lights up in red.
The indicator lamp goes out again after some time. You can adjust the selected mirror using adjustment button **1** as long as the indicator lamp is lit.
- ▶ Press adjustment button **1** up, down, to the right or to the left until the exterior mirror is set to a position that provides you with a good overview of traffic conditions.

Folding the exterior mirrors in or out electrically

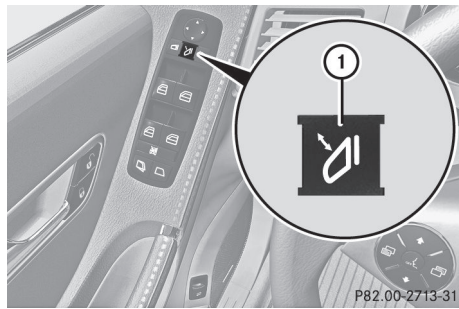

- ▶ Make sure that the SmartKey is in position **1** or **2** in the ignition lock.
- ▶ Briefly press button **1**.
Both exterior mirrors fold in or out.
- i** Make sure that the exterior mirrors are always folded out fully while the vehicle is in motion, as they may otherwise vibrate.
- i** If you are driving faster than 30 mph (47 km/h), you can no longer fold in the exterior mirrors.

Setting the exterior mirrors

If the battery has been disconnected or completely discharged, the exterior mirrors must be reset. The exterior mirrors will otherwise not fold in when you select the "Fold in mirrors when locking" function in the on-board computer (▶ page 209).

- ▶ Make sure that the SmartKey is in position **1** in the ignition lock.
- ▶ Briefly press button **1**.

Folding the exterior mirrors in or out automatically

If the "Fold in mirrors when locking" function is activated in the on-board computer (▶ page 209):

- the exterior mirrors fold in automatically as soon as you lock the vehicle from the outside.
 - the exterior mirrors fold out again automatically as soon as you unlock the vehicle and then open the driver's or front-passenger door.
- i** The mirrors do not fold out if they have been folded in manually.

Exterior mirror out of position

If an exterior mirror has been pushed out of position, proceed as follows:

- ▶ **Vehicles without electrically folding exterior mirrors:** move the exterior mirror into the correct position manually.
- ▶ **Vehicles with electronically folding mirrors:** press the mirror-folding button (▷ page 110) repeatedly until you hear the mirror engage in position. The mirror housing is engaged again and you can adjust the exterior mirrors as usual (▷ page 110).

Automatic anti-glare mirrors

⚠ WARNING

If incident light from headlamps is prevented from striking the sensor in the rear-view mirror, for instance, by luggage piled too high in the vehicle, the mirror's automatic anti-glare function will not operate.

Incident light could then blind you. This may distract you from the traffic conditions and, as a result, you may cause an accident.

The rear-view mirror and the exterior mirror on the driver's side automatically go into anti-glare mode if the ignition is switched on and incident light from headlamps strikes the sensor in the rear-view mirror.

The mirrors do not go into anti-glare mode if reverse gear is engaged or the interior lighting is switched on.

Parking position for the exterior mirror on the front-passenger side

Setting and storing the parking position

You can position the front-passenger side exterior mirror in such a way that you can see the rear wheel on that side as soon as you engage reverse gear. You can store this position.

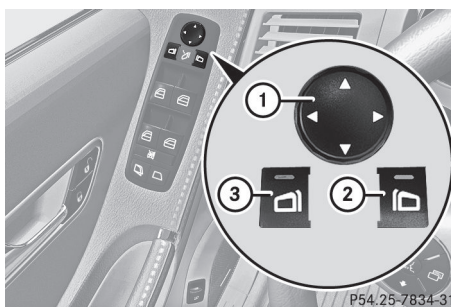

- ▶ Make sure that the vehicle is stationary and that the SmartKey is in position **2** in the ignition lock.
 - ▶ Press button **2** for the exterior mirror on the front-passenger side.
 - ▶ Engage reverse gear. The exterior mirror on the front-passenger side moves to the preset parking position.
 - ▶ Use adjustment button **1** to adjust the exterior mirror to a position that allows you to see the rear wheel and the curb. The parking position is stored.
- i** If you shift the transmission to another position, the exterior mirror on the front-passenger side returns to the driving position.

Calling up a stored parking position setting

- ▶ Turn the SmartKey to position **2** in the ignition lock.
- ▶ Adjust the exterior mirror on the front-passenger side with the corresponding button (▷ page 110).
- ▶ Engage reverse gear.
The exterior mirror on the front-passenger side moves to the stored parking position.

The exterior mirror on the front-passenger side moves back to its original position:

- as soon as you exceed a speed of 6 mph (10 km/h)
- about ten seconds after you have disengaged reverse gear
- if you press button **3** for the exterior mirror on the driver's side

Memory functions

Storing settings

With the memory function, you can store up to three different settings, e.g. for three different people.

The following settings are stored as a single memory preset:

- position of the seat, backrest and head restraint
- driver's side: steering wheel position
- driver's side: position of the exterior mirrors on the driver's and front-passenger sides

WARNING

Do not activate the memory function while driving. Activating the memory function while driving could cause the driver to lose control of the vehicle.

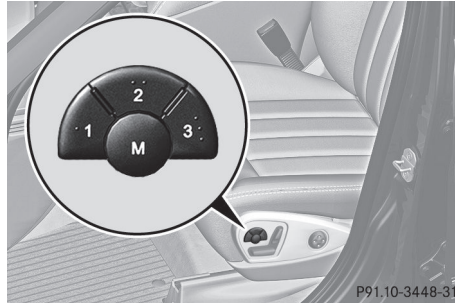

- ▶ Adjust the seat (▷ page 98).
- ▶ On the driver's side, adjust the steering wheel (▷ page 108) and the exterior mirrors (▷ page 110).
- ▶ Press memory button **M** and one of the storage position buttons **1**, **2** or **3** within three seconds.
The settings are stored in the selected preset position. A tone sounds when the settings have been completed.

Calling up a stored setting

- ▶ Press and hold the relevant storage position button **1**, **2** or **3** until the seat, steering wheel and exterior mirrors are in the stored position.
- i** The setting procedure is interrupted as soon as you release the storage position button.

Useful information	114
Exterior lighting	114
Interior lighting	118
Replacing bulbs	119
Windshield wipers	124

Useful information

- i** This Operator's Manual describes all models and all standard and optional equipment of your vehicle available at the time of publication of the Operator's Manual. Country-specific differences are possible. Please note that your vehicle may not be equipped with all features described. This also applies to safety-related systems and functions.
- i** Please read the information on qualified specialist workshops (▷ page 24).

Exterior lighting

Important safety notes

For reasons of safety, Mercedes-Benz recommends that you drive with the lights switched on even during the daytime. In some countries, operation of the headlamps varies due to legal requirements and self-imposed obligations.

Information about driving abroad

Converting to symmetrical low beam when driving abroad: switch the headlamps to symmetrical low beam in countries in which traffic drives on the opposite side of the road to the country where the vehicle is registered. This prevents glare to oncoming traffic. Symmetrical lights do not illuminate as large an area of the edge of the road.

Have the headlamps converted at a qualified specialist workshop, e.g. an authorized Mercedes-Benz Center, as close to the border as possible before driving in these countries.

Converting to asymmetrical low beam after returning: have the headlamps converted back to asymmetrical low beam at a qualified specialist workshop, e.g. an authorized Mercedes-Benz Center, as soon as possible after crossing the border again.

Light switch

Operation

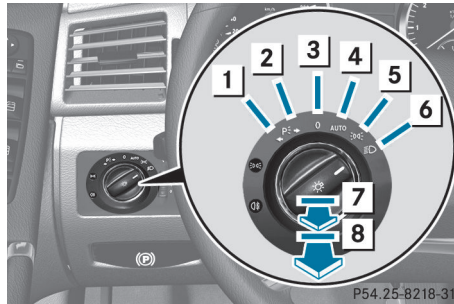

- 1** Left-hand standing lamps
- 2** Right-hand standing lamps
- 3** **0** Lights off/daytime running lamps
- 4** **AUTO** Automatic headlamp mode/daytime running lamps
- 5** Parking lamps, license plate and instrument cluster lighting
- 6** Low-beam/high-beam headlamps
- 7** Vehicles without front fog lamps: rear fog lamp
- 7** Vehicles with front fog lamps: front fog lamp
- 8** Vehicles with front fog lamps: rear fog lamp

The turn signals, high-beam headlamps and the high-beam flasher are operated using the combination switch (▷ page 117).

- !** Switch off the parking lamps and standing lamps when you leave the vehicle. This prevents the battery from discharging.

The exterior lighting (except the parking/standing lamps) switches off automatically if you:

- remove the SmartKey from the ignition lock
- open the driver's door with the SmartKey in position **0**



If you hear a warning tone when you leave the vehicle, the lights may still be switched on.

▶ Turn the light switch to **0** or **AUTO**.
or

▶ If the rear fog lamp is switched on: press the light switch in to the stop.

Low-beam headlamps

▶ **To switch on the low-beam headlamps:** turn the SmartKey in the ignition lock to position **2** or start the engine.



▶ Turn the light switch to .
The  indicator lamp in the instrument cluster lights up.

▶ **To switch off the low-beam headlamps:** turn the light switch to **0**.

Daytime running lamps

Daytime running lamps in Canada

The "daytime running lamps" function is required by law in Canada. It cannot therefore be deactivated.

▶ Turn the light switch to **0** or **AUTO**.
With the engine running: depending on the ambient light, the daytime running lamps or the low-beam headlamps are switched on. When the low-beam headlamps are activated, the  indicator lamp on the light switch and the  indicator lamp in the instrument cluster light up.

If the light switch is set to **0** or **AUTO**, you cannot activate the high-beam headlamps.

Turn the light switch to  when driving at night. You can switch on the high-beam headlamps in this position.



When the engine is running and the vehicle is stationary: if you move the selector lever from a driving position to **N** or **P**, the low-beam headlamps go out after three minutes.

When the engine is running and the vehicle is stationary: if you turn the light switch to , the parking lamps and the low-beam headlamps are switched on.

Daytime running lamps in the USA



In the USA, the daytime running lamps are deactivated upon delivery from the factory.

▶ **To activate the daytime running lamps:** activate the daytime running lamps function in the on-board computer (▷ page 206).

▶ Turn the light switch to **0** or **AUTO**.
With the engine running: the low-beam headlamps are switched on. The  indicator lamp on the light switch and the  indicator lamp in the instrument cluster light up.

It is only possible to activate the high-beam headlamps if the brightness of the ambient light is at a low level.

However, the high-beam flasher can always be used.

If the engine is running and you turn the light switch to  or , the manual settings take precedence over the daytime running lamps.

Automatic headlamp mode

▶ **To switch on automatic headlamp mode:** turn the light switch to **AUTO**.
SmartKey in position **1** in the ignition lock: the parking lamps are switched on or off automatically depending on the brightness of the ambient light.

With the engine running: depending on the brightness of the ambient light, the daytime running lamps¹⁰ or the low-beam headlamps are switched on or off automatically.

When the low-beam headlamps are switched on, the  indicator lamp in the instrument cluster lights up.

WARNING

If the light switch is set to **AUTO**, the low-beam headlamps will not come on automatically if it is foggy. This could endanger you and

¹⁰ Only if daytime running lamps have been activated via the on-board computer.

others. Therefore, turn the light switch to  in fog.

The automatic headlamp feature is only an aid. The driver is responsible for the vehicle's lighting at all times.

WARNING

In low ambient lighting or foggy conditions, only switch from position **AUTO** to  with the vehicle at a standstill in a safe location.

Switching from **AUTO** to  will briefly switch off the headlamps. Doing so while driving in low ambient lighting conditions may result in an accident.

Front fog lamps and rear fog lamp

Front fog lamps

Only vehicles with front fog lamps have the "fog lamps" function.



WARNING



If you suspect that driving conditions will be foggy, turn the light switch to  before you start your journey. Otherwise, your vehicle may not be visible and you could endanger yourself and others.

WARNING











In low ambient lighting or foggy conditions, only switch from position **AUTO** to  with the vehicle at a standstill in a safe location.



Switching from **AUTO** to  will briefly switch off the headlamps. Doing so while driving in low ambient lighting conditions may result in an accident.

- ▶ **To switch on the front fog lamps:** turn the SmartKey in the ignition lock to position **2** or start the engine.
- ▶ Turn the light switch to  or . If the light switch is set to **AUTO**, you cannot switch on the fog lamps.

- ▶ Pull the light switch out to the first detent. The green  indicator lamp on the light switch lights up.
- ▶ **To switch off the front fog lamps:** press the light switch in as far as it will go. The green  indicator lamp on the light switch goes out.

Rear fog lamp

- ▶ **To switch on (vehicles with front fog lamps):** turn the SmartKey in the ignition lock to position **2** or start the engine.
- ▶ Turn the light switch to  or . When the light switch is set to **AUTO**, you cannot switch on the rear fog lamp.
- ▶ Turn the light switch to . When the light switch is set to , you cannot switch on the rear fog lamp.
- ▶ Pull the light switch out to the second stop. The yellow  indicator lamp on the light switch lights up.
- ▶ **To switch off the rear fog lamp:** press the light switch in as far as it will go. The yellow  indicator lamp on the light switch goes out.
- ▶ **To switch on (vehicles without front fog lamps):** turn the SmartKey in the ignition lock to position **2** or start the engine.
- ▶ Turn the light switch to . When the light switch is set to **AUTO**, you cannot switch on the rear fog lamp.
- ▶ Turn the light switch to . When the light switch is set to **A**, you cannot switch on the rear fog lamp.
- ▶ Pull the light switch out to the stop. The yellow  indicator lamp on the light switch lights up.
- ▶ Pull the light switch out to the stop. The yellow  indicator lamp in the instrument cluster lights up.

- ▶ **To switch off the rear fog lamp:** press the light switch in as far as it will go. The yellow  indicator lamp on the light switch goes out.
- ▶ **To switch off the rear fog lamp:** press the light switch in as far as it will go. The yellow  indicator lamp in the instrument cluster goes out.

Headlamp cleaning system

The headlamps are cleaned automatically if the "Wipe with washer fluid" function is operated ten times while the lights are on and the engine is running (▷ page 124). When you switch off the ignition, the automatic headlamp cleaning system is reset and counting is resumed from 0.

Combination switch

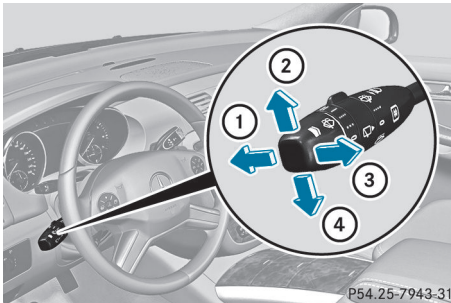

Turn signals



- ① High-beam headlamps
- ② Right turn signal
- ③ High-beam flasher
- ④ Left turn signal

- ▶ **To indicate briefly:** press the combination switch briefly to the pressure point in the direction of arrow ② or ④. The corresponding turn signal flashes three times.
- ▶ **To indicate:** press the combination switch beyond the pressure point in the direction of arrow ② or ④.

High-beam headlamps

- ▶ **To switch on the high-beam headlamps:** turn the SmartKey in the ignition lock to position 2 or start the engine.
- ▶ Turn the light switch to .
- ▶ Press the combination switch beyond the pressure point in the direction of arrow ①. The  indicator lamp in the instrument cluster lights up.
- ▶ **To switch off the high-beam headlamps:** move the combination switch back to its normal position. The  indicator lamp in the instrument cluster goes out.

High-beam flasher

- ▶ **To switch on:** turn the SmartKey in the ignition lock to position 1 or 2 or start the engine.
- ▶ Pull the combination switch in the direction of arrow ③.

Hazard warning lamps



The hazard warning lamps automatically switch on if:

- an air bag is deployed.
- the vehicle is slowed down severely from a speed of over 45 mph (70 km/h) and comes to a halt.

- ▶ **To switch on the hazard warning lamps:** press button ①.

All turn signals flash. If you now switch on a turn signal using the combination switch, only the turn signal lamp on the corresponding side of the vehicle will flash.

- ▶ **To switch off the hazard warning lamps:** press button ①.

The hazard warning lamps are deactivated automatically if the vehicle returns to a speed of over 6 mph (10 km/h) after a full application of the brakes.

- ⓘ The hazard warning lamps still operate if the ignition is switched off.

Headlamps fogged up on the inside

The headlamps may fog up on the inside if there is high atmospheric humidity.

- ▶ Drive with the headlamps switched on. The level of moisture diminishes, depending on the length of the journey and the weather conditions (humidity and temperature).

If the level of moisture does not diminish:



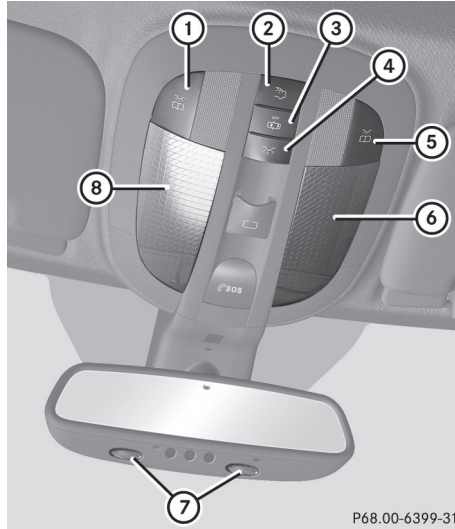

- ▶ Have the headlamps checked at a qualified specialist workshop.

Interior lighting

Overview of interior lighting



Front overhead control panel

- ①  Switches the left-hand front reading lamp on/off
- ②  Switches the rear interior lighting on/off
- ③  Switches the automatic interior lighting control on/off
- ④  Switches the front interior lighting on/off
- ⑤  Switches the right-hand front reading lamp on/off
- ⑥ Front interior lighting
- ⑦ Front reading lamps
- ⑧ Front interior lighting

P68.00-6399-31

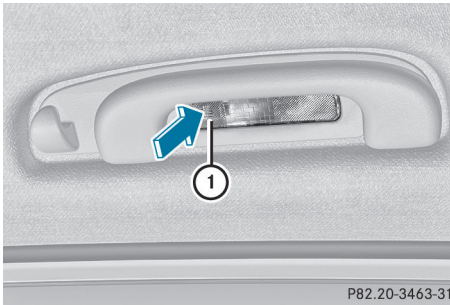

Rear overhead control panel (second row of seats)

① Switches the reading lamp on/off

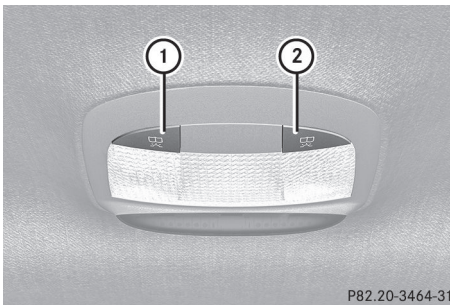

Rear overhead control panel (third row of seats)

① Switches the left-hand reading lamp on/off

② Switches the right-hand reading lamp on/off

Interior lighting control

Important notes

In order to prevent the vehicle's battery from discharging, the interior lighting functions are automatically deactivated after some time except for when the SmartKey is in position 2 in the ignition lock.

Automatic interior lighting control

- ▶ **To switch on/off:** press the button. When the automatic interior lighting control is activated, the button is flush with the overhead control panel.

The interior lighting automatically switches on if you:

- unlock the vehicle
- open a door
- remove the SmartKey from the ignition lock

The interior light is activated for a short while when the SmartKey is removed from the ignition lock. You can activate this delayed switch-off using the on-board computer (> page 208).

Manual interior lighting control

- ▶ **To switch the front interior lighting on/off:** press the button.
- ▶ **To switch the rear interior lighting on/off:** press the button.
- ▶ **To switch the reading lamps on/off:** press the button.

Crash-responsive emergency lighting

The interior lighting is activated automatically if the vehicle is involved in an accident.

- ▶ **To switch off the crash-responsive emergency lighting:** press the hazard warning lamp button.

or

- ▶ Lock and then unlock the vehicle using the key.

Replacing bulbs

Important safety notes

Xenon bulbs

If your vehicle is equipped with Xenon bulbs, you can recognize this by the following: the cone of light from the Xenon bulbs moves from the top to the bottom and back again when you start the engine. For this to be observed, the lights must be switched on before starting the engine.

⚠ DANGER

Xenon bulbs carry a high voltage. You could get an electric shock and be seriously or even fatally injured if you touch the electric contacts on Xenon bulbs. Therefore, never remove the cover from Xenon bulbs.

Do not change Xenon bulbs yourself, but have them replaced at a qualified specialist workshop which has the necessary specialist knowledge and tools to carry out the work required.

Mercedes-Benz recommends that you use an authorized Mercedes-Benz Center for this purpose. In particular, work relevant to safety or on safety-related systems must be carried out at a qualified specialist workshop.

Bulbs and lamps are an important aspect of vehicle safety. You must therefore make sure that these function correctly at all times. Have the headlamp setting checked regularly.

Other bulbs

There are bulbs other than the Xenon bulbs that you cannot replace. Replace only the bulbs listed (▷ page 120). Have the bulbs that you cannot replace yourself changed at a qualified specialist workshop.

Mercedes-Benz recommends that you use an authorized Mercedes-Benz Center for this purpose. In particular, work relevant to safety or on safety-related systems must be carried out at a qualified specialist workshop.

If you require assistance changing bulbs, consult a qualified specialist workshop.

Do not touch the glass tube of new bulbs with your bare hands. Even minor contamination can burn into the glass surface and reduce the service life of the bulbs. Always use a lint-free cloth or only touch the base of the bulb when installing.

Only use bulbs of the correct type.

If the new bulb still does not light up, consult a qualified specialist workshop.

Bulbs and lamps are an important aspect of vehicle safety. You must therefore make sure that these function correctly at all times. Have the headlamp setting checked regularly.

⚠ WARNING

Bulbs and lamps can be very hot. You should therefore allow them to cool down before you change them. Otherwise, you could be burned if you touch them.

Keep bulbs out of the reach of children. Otherwise, they could damage the bulbs, for example, and injure themselves.

Never use a bulb which has been dropped. Such a bulb may break or even explode and injure you.

Halogen bulbs are pressurized and can explode when you change them, particularly if they are very hot. You should therefore wear eye protection and gloves when you are changing them.

Overview: changing bulbs/bulb types

You can change the following bulbs. The bulb type can be found in the legend.

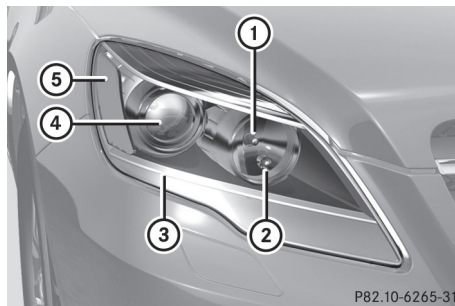
**Halogen headlamps**

- ① High-beam headlamp: H7 55 W
- ② Parking lamp/standing lamp: W 5 W BV
- ③ Turn signal lamp: WY 5 W
- ④ Low-beam headlamp: H7 55 W
- ⑤ Side marker lamp: WY 5 W

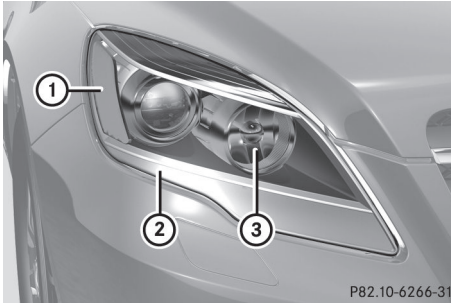

P82.10-6266-31

Bi-Xenon headlamps

- ① Side marker lamp: WY 5 W
- ② Turn signal lamp: WY 5 W
- ③ Parking lamp/standing lamp: W 5 W BV



P82.10-6219-31

Tail lamp

- ① Backup lamp: W 16 W

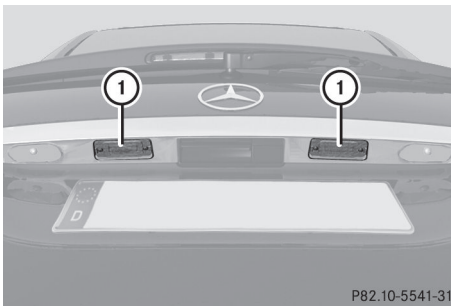

P82.10-5541-31

License plate lamp

- ① License plate lamp: C 5 W

Changing the front bulbs

Removing and installing the cover in the front wheel arch

You must remove the cover from the front wheel housing before you can change the front bulbs.

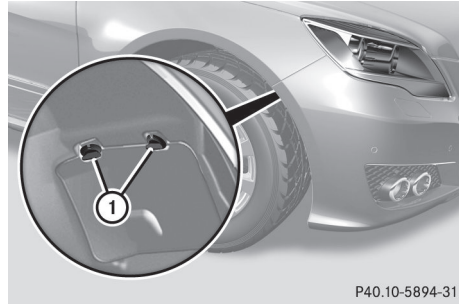

P40.10-5894-31

- ▶ **To remove:** switch off the lights.
- ▶ Turn the front wheels inwards.
- ▶ Turn rotary catch ① 90° counter-clockwise.
- ▶ Pull away the cover and lift it off.
- ▶ **To install:** re-insert the cover.
- ▶ Turn rotary catch ① 90° clockwise.

Low-beam headlamps (halogen headlamps)

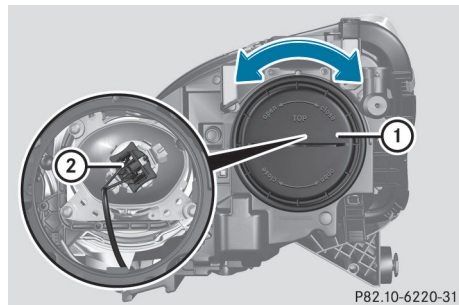

P82.10-6220-31

- ▶ Remove the cover in the front wheel arch (▷ page 121).
- ▶ Turn housing cover ① counter-clockwise and pull it out.

- ▶ Turn bulb holder ② counter-clockwise and pull it out.
- ▶ Take the bulb out of bulb holder ②.
- ▶ Insert the new bulb into bulb holder ②.
- ▶ Insert bulb holder ② into the lamp and turn it clockwise.
- ▶ Align housing cover ① and turn it clockwise until it engages.
- ▶ Replace the cover in the front wheel arch (▷ page 121).

High-beam headlamps (halogen headlamps)

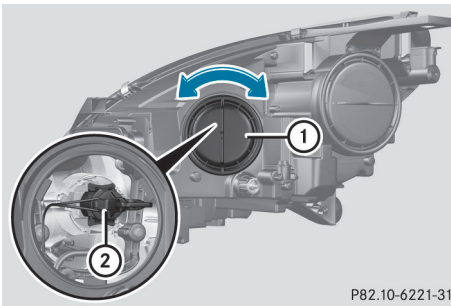

P82.10-6221-31

- ▶ Remove the cover in the front wheel arch (▷ page 121).
- ▶ Turn housing cover ① counter-clockwise and pull it out.
- ▶ Turn bulb holder ② counter-clockwise and pull it out.
- ▶ Take the bulb out of bulb holder ②.
- ▶ Insert the new bulb into bulb holder ②.
- ▶ Insert bulb holder ② into the lamp and turn it clockwise.
- ▶ Align housing cover ① and turn it clockwise until it engages.
- ▶ Replace the cover in the front wheel arch (▷ page 121).

Parking lamp/standing lamp

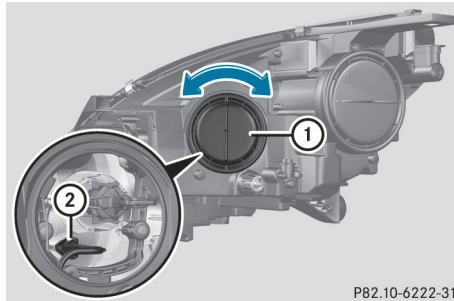

P82.10-6222-31

- ▶ Remove the cover in the front wheel arch (▷ page 121).
- ▶ Turn housing cover ① counter-clockwise and pull it out.
- ▶ Pull out bulb holder ②.
- ▶ Take the bulb out of bulb holder ②.
- ▶ Insert the new bulb into bulb holder ②.
- ▶ Insert bulb holder ②.
- ▶ Align housing cover ① and turn it clockwise until it engages.
- ▶ Replace the cover in the front wheel arch (▷ page 121).

Turn signals

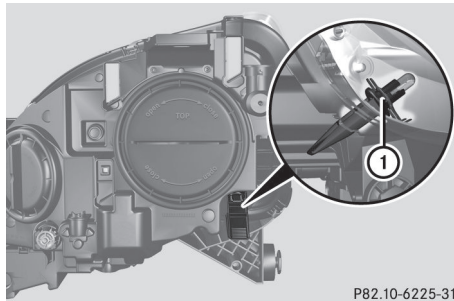

P82.10-6225-31

- ▶ Remove the cover in the front wheel arch (▷ page 121).
- ▶ Pull out bulb holder ①.
- ▶ Take the bulb out of bulb holder ①.
- ▶ Insert the new bulb into bulb holder ①.

- ▶ Insert bulb holder ①.
- ▶ Replace the cover in the front wheel arch (▷ page 121).

Side marker lamp

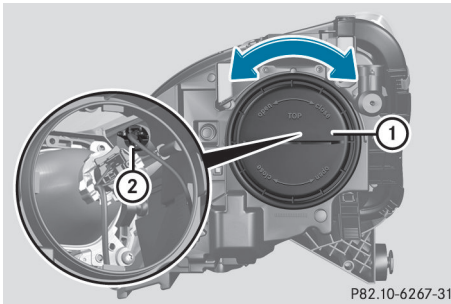

- ▶ Remove the cover in the front wheel arch (▷ page 121).
- ▶ Turn housing cover ① counter-clockwise and pull it out.
- ▶ Pull out bulb holder ②.
- ▶ Take the bulb out of bulb holder ②.
- ▶ Insert the new bulb into bulb holder ②.
- ▶ Insert bulb holder ②.
- ▶ Align housing cover ① and turn it clockwise.
- ▶ Install the cover in the front wheel arch (▷ page 121).

Changing the rear bulbs

Opening and closing the side trim panels

You must open the side trim panel in the cargo compartment before you can change the bulbs in the backup lamp.

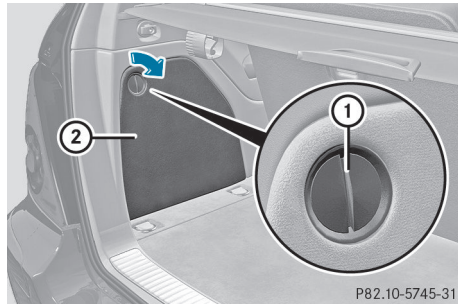

Left-hand side trim panel

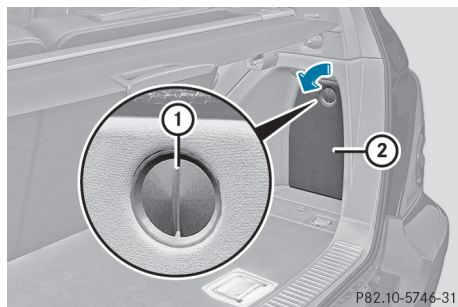

Right-hand side trim panel

- ▶ **To open:** insert a suitable object, e.g. a coin, into the slot of release knob ① on side trim panel ②.
- ▶ Turn release knob ① 90° in the direction of the arrow and remove side trim panel ②.
- ▶ **To close:** insert side trim panel ② and turn release knob ① 90° in the opposite direction to the arrow.

Backup lamp

- ▶ Switch off the lights.
- ▶ Open the cargo compartment.
- ▶ Open the side trim panel (▷ page 123).

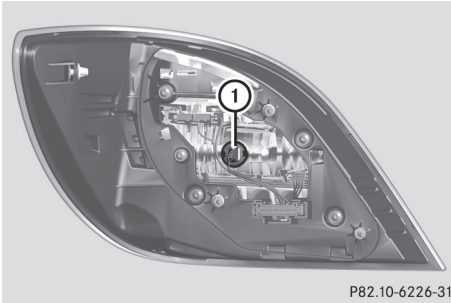

P82.10-6226-31

① Backup lamp

- ▶ Turn the bulb holder counter-clockwise and remove it.
- ▶ Remove the bulb from the bulb holder.
- ▶ Insert the new bulb into the bulb holder.
- ▶ Insert the bulb holder and turn it clockwise.
- ▶ Close the side trim panel (▷ page 123).

License plate lamps

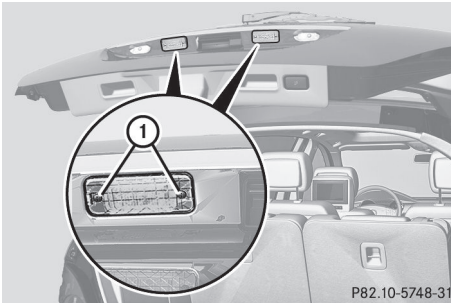

P82.10-5748-31

- ▶ Switch off the lights.
- ▶ Open the tailgate.
- ▶ Remove screws ①.
- ▶ Remove the license plate lamp.
- ▶ Replace the bulb.
- ▶ Insert the license plate lamp.
- ▶ Replace and tighten screws ①.

¹¹ Rain sensor set to low sensitivity.

¹² Rain sensor set to high sensitivity.

Windshield wipers

Switching the windshield wipers on/off

WARNING

Wiper blades are components that are subject to wear and tear. Replace the wiper blades twice a year, preferably in the spring and fall. Otherwise the windows will not be wiped properly. As a result, you may not be able to observe surrounding traffic conditions and could cause an accident.

! Do not operate the windshield wipers when the windshield is dry, as this could damage the wiper blades. Moreover, dust that has collected on the windshield can scratch the glass if wiping takes place when the windshield is dry.

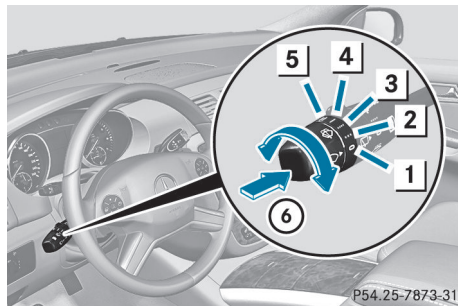

! If the windshield wipers leave smears on the windshield after the vehicle has been washed in an automatic car wash, wax or other residues may be the reason for this. Clean the windshield using washer fluid after washing the vehicle in an automatic car wash.



P54.25-7873-31

Combination switch





- ① **0** Windshield wipers off
- ② **...** Intermittent wipe, low¹¹
- ③ **...** Intermittent wipe, high¹²
- ④ **—** Continuous wipe, slow

- 5  Continuous wipe, fast
- 6  Single wipe /  To wipe the windshield using washer fluid

- ▶ Switch on the ignition.
- ▶ Turn the combination switch to the corresponding position.

! Intermittent wiping with rain sensor: due to optical influences and the windshield becoming dirty in dry weather conditions, the windshield wipers may be activated inadvertently. This could then damage the windshield wiper blades or scratch the windshield.



For this reason, you should always switch off the windshield wipers in dry weather.

In the  or  position, the appropriate wiping frequency is set automatically according to the intensity of the rain. In the  position, the rain sensor is more sensitive than in the  position, causing the windshield wipers to wipe more frequently.

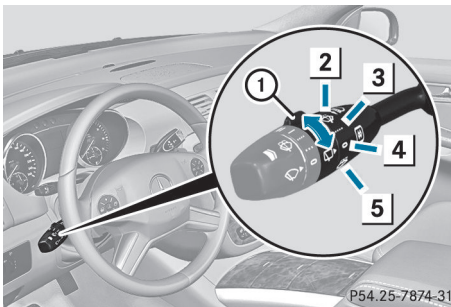
Switching the rear window wiper on/off



Combination switch

- 1  Switch
- 2  To wipe with washer fluid
- 3 **I** To switch on intermittent wiping
- 4 **0** To switch off intermittent wiping
- 5  To wipe with washer fluid

- ▶ Turn the SmartKey to position **1** or **2** in the ignition lock.
- ▶ Turn switch ① on the combination switch to the corresponding position. When the rear window wiper is switched on, the icon appears in the instrument cluster.

Replacing the wiper blades

Important safety notes

WARNING

For safety reasons, switch off the windshield wipers and remove the key from the ignition lock before changing the wiper blades (vehicles with KEYLESS-GO: make sure that the on-board electronics are in state **0**). Otherwise, the wiper motor could be switched on suddenly and cause injury.

- !** To avoid damaging the wiper blades, make sure that you touch only the wiper arm of the wiper.
- !** Never open the hood if a windshield wiper arm has been folded away from the windshield. Never fold a windshield wiper arm without a wiper blade back onto the windshield/rear window. Hold the windshield wiper arm firmly when you change the wiper blade. If you release the windshield wiper arm without a wiper blade and it falls onto the windshield, the windshield may be damaged by the force of the impact. Mercedes-Benz recommends that you have the wiper blades replaced by a qualified specialist workshop, e.g. at an authorized Mercedes-Benz Center.

Replacing the windshield wiper blades

Removing the wiper blades

- ▶ Remove the SmartKey from the ignition lock.
- ▶ Fold the wiper arm away from the windshield.

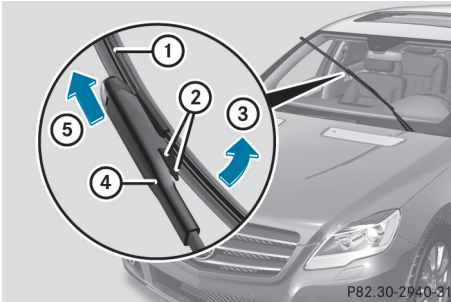

- ▶ Press both release clips ②.
- ▶ Fold wiper blade ① in the direction of arrow ③ away from wiper arm ④.
- ▶ Remove wiper blade ① in the direction of arrow ⑤.

Installing the wiper blades

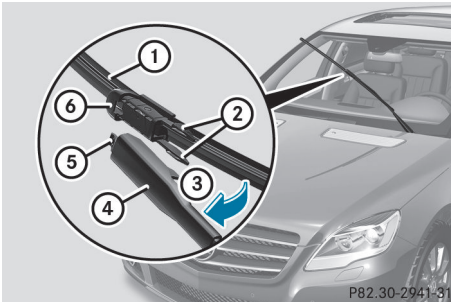

- ▶ Position the new wiper blade ① with recess ⑥ on lug ⑤.
- ▶ Fold wiper blade ① in the direction of arrow ③ onto the wiper arm, until retaining clips ② engage in bracket ④.
- ▶ Make sure that wiper blade ① is seated correctly.
- ▶ Fold the wiper arm back onto the windshield.

Replacing the rear window wiper blade

Removing the wiper blade

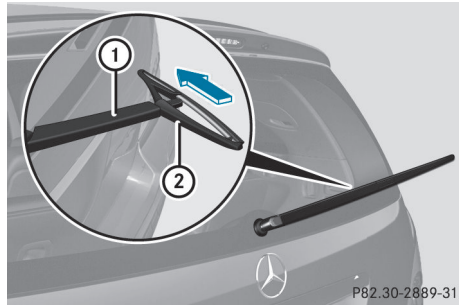

- ▶ Remove the SmartKey from the ignition lock.
- ▶ Fold wiper arm ① away from the rear window until it engages.
- ▶ Position wiper blade ② at a right angle to wiper arm ①.
- ▶ Hold wiper arm ① and press wiper blade ② in the direction of the arrow until it releases.
- ▶ Remove wiper blade ②.

Installing the wiper blade

- ▶ Place new wiper blade ② onto wiper arm ①.
- ▶ Hold wiper arm ① and press wiper blade ② in the opposite direction to the arrow until it engages.
- ▶ Make sure that wiper blade ② is seated correctly.
- ▶ Position wiper blade ② parallel to wiper arm ①.
- ▶ Fold wiper arm ① back onto the rear window.

Problems with the windshield wipers

The windshield wipers are obstructed

Leaves or snow, for example, may be obstructing the windshield wiper movement. The wiper motor has been deactivated.

- ▶ For safety reasons, you should remove the SmartKey from the ignition lock.

or

- ▶ Switch off the engine using the Start/Stop button and open the driver's door.
- ▶ Remove the cause of the obstruction.
- ▶ Switch the windshield wipers back on.

The windshield wipers are inoperative

The windshield wiper drive is malfunctioning.

- ▶ Select another wiper speed on the combination switch.
- ▶ Have the windshield wipers checked at a qualified specialist workshop.

The spray nozzles are misaligned

The windshield washer fluid from the spray nozzles no longer hits the center of the windshield. The spray nozzles are misaligned.

- ▶ Have the spray nozzles adjusted at a qualified specialist workshop.

Useful information	130
Overview of climate control systems	130
Operating the climate control system	134
Setting the air vents	141

Useful information

- i** This Operator's Manual describes all models and all standard and optional equipment of your vehicle available at the time of publication of the Operator's Manual. Country-specific differences are possible. Please note that your vehicle may not be equipped with all features described. This also applies to safety-related systems and functions.
- i** Please read the information on qualified specialist workshops (▷ page 24).

sunroof/panorama roof with power tilt/sliding panel closed.

- i** Ventilate the vehicle for a brief period during warm weather, e.g. using the convenience opening feature (▷ page 87). This will speed up the cooling process and the desired vehicle interior temperature will be reached more quickly.
- i** The integrated filter can filter out most particles of dust and completely filters out pollen. A clogged filter reduces the amount of air supplied to the vehicle interior. For this reason, you should always observe the interval for replacing the filter, which is specified in the Service Booklet. As it depends on environmental conditions, e.g. heavy air pollution, the interval may be shorter than stated in the Service Booklet.

Overview of climate control systems

Important safety notes

 **WARNING**

Severe conditions (e.g. strong air pollution) may require replacement of the filter before its scheduled replacement interval. A clogged filter will reduce the air volume to the interior and the windows could fog up, impairing visibility and endangering you and others. Have a blocked filter replaced at a Mercedes-Benz Center as soon as possible.

 **WARNING**

Follow the recommended settings for heating and cooling given on the following pages. Otherwise, the windows could fog up, impairing visibility and endangering you and others.

The automatic climate control¹³ adjusts the temperature and the humidity of the vehicle interior and filters undesired substances from the air.

The automatic climate control¹³ is only operational when the engine is running.¹⁴ Optimum operation is only achieved if you drive with the side windows and sliding

¹³ Canada only.

¹⁴ Automatic climate control: the residual heat function can only be activated/deactivated when the ignition is switched off.

Control panel for dual-zone automatic climate control

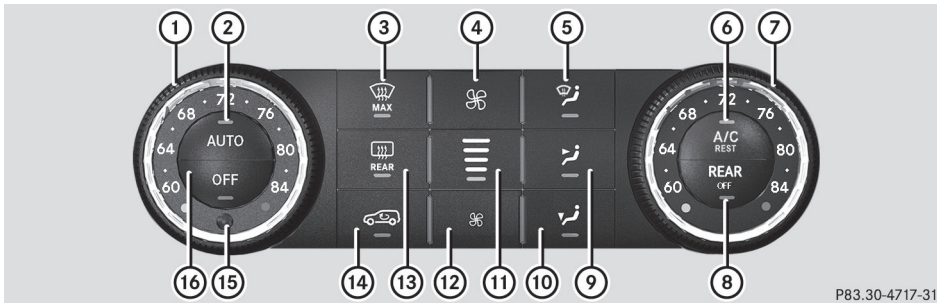

P83.30-4717-31

- ① To set the temperature, left (▷ page 137)
- ② To set climate control to automatic (▷ page 136)
- ③ To defrost the windshield (▷ page 138)
- ④ To increase the airflow (▷ page 138)
- ⑤ To direct the airflow through the defroster vents (▷ page 138)
- ⑥ To activate/deactivate cooling with air dehumidification (▷ page 135)
- ⑦ To set the temperature, right (▷ page 137)
- ⑧ To switch rear-compartment climate control on/off (▷ page 134)
- ⑨ To direct the airflow through the center and side air vents (▷ page 138)
- ⑩ To direct the airflow to the footwells and side air vents (▷ page 138)
- ⑪ To display the airflow level
- ⑫ To reduce the airflow (▷ page 138)
- ⑬ To switch the rear window defroster on/off (▷ page 139)
- ⑭ To activate/deactivate air-recirculation mode (▷ page 140)
- ⑮ Interior temperature sensor
- ⑯ To switch climate control on/off (▷ page 134)

Notes on using dual-zone automatic climate control

The following contains notes and recommendations on optimum use of dual-zone automatic climate control.

- Activate climate control using the **AUTO** and **A/C REST** buttons. The indicator lamps in the **AUTO** and **A/C REST** buttons light up.
- Set the temperature to 72 °F (22 °C).
- Only use the "defrosting" function briefly until the windshield is clear again.
- Only use "air-recirculation" mode briefly, e.g. if there are unpleasant outside odors

or when in a tunnel. The windows could otherwise fog up as, in air-recirculation mode, no fresh air is drawn into the vehicle.

- Use the residual heat function if you want to heat or ventilate the vehicle interior when the ignition is switched off. The "residual heat" function can only be activated or deactivated with the ignition switched off.

Control panel for 3-zone automatic climate control

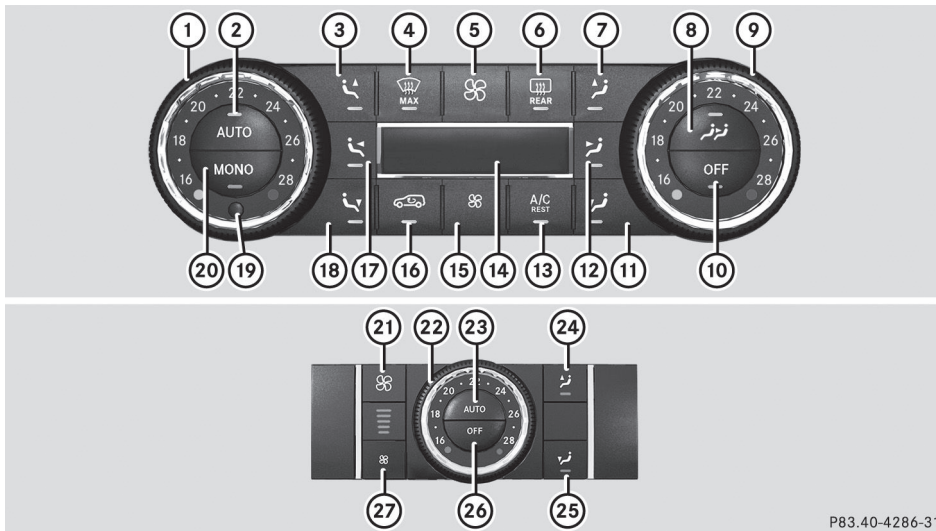

P83.40-4286-31

Canada only

Front control panel

- ① To set the temperature, left (▷ page 137)
- ② To set climate control to automatic (▷ page 136)
- ③ To direct the airflow through the defroster vents, left (▷ page 138)
- ④ To defrost the windshield (▷ page 138)
- ⑤ To increase the airflow (▷ page 138)
- ⑥ To switch the rear window defroster on/off (▷ page 139)
- ⑦ To direct the airflow through the defroster vents, right (▷ page 138)
- ⑧ To operate the rear-compartment climate control via the front control panel (▷ page 134)
- ⑨ To set the temperature, right (▷ page 137)
- ⑩ To switch climate control on/off (▷ page 134)
- ⑪ To direct the airflow to the footwells and side air vents, right (▷ page 138)
- ⑫ To direct the airflow through the center and side air vents, right (▷ page 138)
- ⑬ To activate/deactivate cooling with air dehumidification (▷ page 135)
To activate/deactivate the residual heat function (▷ page 140)
- ⑭ Display
- ⑮ To reduce the airflow (▷ page 138)
- ⑯ To activate/deactivate air-recirculation mode (▷ page 140)
- ⑰ To direct the airflow through the center and side air vents, left (▷ page 138)
- ⑱ To direct the airflow to the footwells and side air vents, left (▷ page 138)
- ⑲ Interior temperature sensor

- ⑳ To switch the MONO function on/off (▷ page 138)

Rear control panel

- ㉑ To increase the airflow (▷ page 138)
- ㉒ To set the temperature (▷ page 137)
- ㉓ To set the rear-compartment climate control to automatic (▷ page 136)
- ㉔ To direct the airflow through the rear air vents (▷ page 138)
- ㉕ To direct the airflow through the footwell vents (▷ page 138)
- ㉖ To switch rear-compartment climate control on/off (▷ page 134)
- ㉗ To reduce the airflow (▷ page 138)

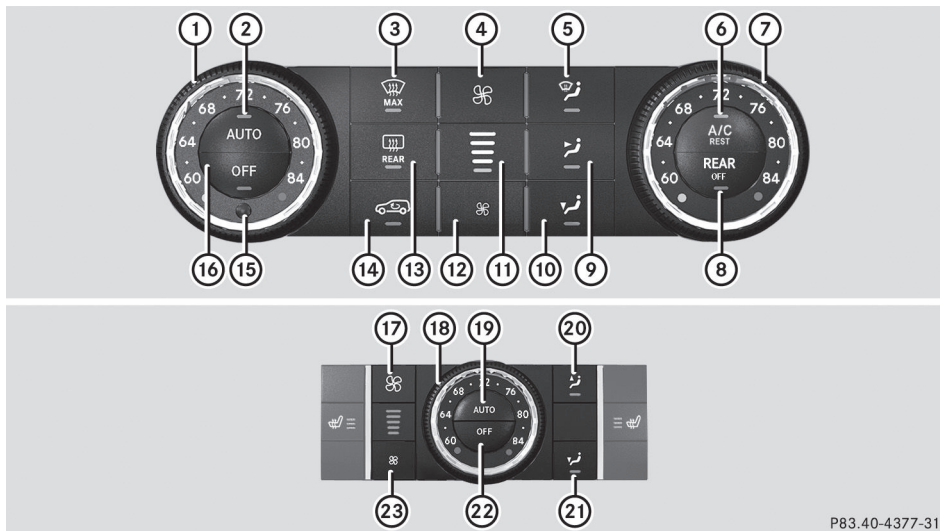

Climate control

P83.40-4377-31

USA only

Front control panel

- ① To set the temperature, left (▷ page 137)
- ② To set climate control to automatic (▷ page 136)
- ③ To defrost the windshield (▷ page 138)
- ④ To increase the airflow (▷ page 138)
- ⑤ To direct the airflow through the defroster vents (▷ page 138)
- ⑥ To activate/deactivate cooling with air dehumidification (▷ page 135)
To activate/deactivate the residual heat function (▷ page 140)
- ⑦ To set the temperature, right (▷ page 137)
- ⑧ To switch rear-compartment climate control on/off (▷ page 134)
- ⑨ To direct the airflow through the center and side air vents (▷ page 138)
- ⑩ To direct the airflow to the footwells and side air vents (▷ page 138)
- ⑪ To display the airflow level





- ⑫ To reduce the airflow (▷ page 138)
- ⑬ To switch the rear window defroster on/off (▷ page 139)
- ⑭ To activate/deactivate air-recirculation mode (▷ page 140)
- ⑮ Interior temperature sensor
- ⑯ To switch climate control on/off (▷ page 134)

Rear control panel

- ⑰ To increase the airflow (▷ page 138)
- ⑱ To set the temperature (▷ page 137)
- ⑲ To set the rear-compartment climate control to automatic (▷ page 136)
- ⑳ To direct the airflow through the rear air vents (▷ page 138)
- ㉑ To direct the airflow through the footwell vents (▷ page 138)
- ㉒ To switch rear-compartment climate control on/off (▷ page 134)
- ㉓ To reduce the airflow (▷ page 138)

Notes on using 3-zone automatic climate control

The following contains instructions and recommendations to enable you to get the most out of your automatic climate control.

- Activate climate control using the **AUTO** and  buttons. The indicator lamps in the  and  buttons light up.
- Set the temperature to 72 °F (22 °C).
- Only use the "defrosting" function briefly until the windshield is clear again.
- Only use "air-recirculation" mode briefly, e.g. if there are unpleasant outside odors or when in a tunnel. The windows could otherwise fog up as, in air-recirculation mode, no fresh air is drawn into the vehicle.
- Use the MONO function if you want to adopt the temperature and air distribution settings from the driver's side for all climate zones. The indicator lamp in the  button lights up.
- Use the residual heat function if you want to heat or ventilate the vehicle interior when the ignition is switched off. The "residual heat" function can only be activated or deactivated with the ignition switched off.

Operating the climate control system

Activating/deactivating climate control

Important information

WARNING

When the climate control system is deactivated, the outside air supply and circulation are also deactivated. Only choose this setting for a short time. Otherwise the windows could fog up, impairing visibility and endangering you and others.

- ① Switch on climate control primarily using the  button (▷ page 136).

Switching the front climate control on/off using the front control panel

- ▶ Turn the SmartKey to position **2** in the ignition lock.
- ▶ **To switch on:** press the **AUTO** button. The indicator lamp in the **AUTO** button lights up. Airflow and air distribution are set to automatic mode.

or

- ▶ Press the **OFF** button. The indicator lamp in the **OFF** button goes out. The previously selected settings come into effect again.
- ▶ **To switch off:** press the **OFF** button. The indicator lamp in the **OFF** button lights up.

Switching the rear-compartment climate control on/off using the front control panel

2-zone automatic climate control

- ▶ Turn the SmartKey to position **2** in the ignition lock.
- ▶ **To switch on/off:** press the **REAR OFF** button. The indicator lamp in the **REAR OFF** button lights up or goes out.

3-zone automatic climate control

USA only:

- ▶ Turn the SmartKey to position **2** in the ignition lock.
- ▶ **To switch on/off:** press the **REAR OFF** button. The indicator lamp in the **REAR OFF** button lights up or goes out.

Canada only:

- ▶ Turn the SmartKey to position **2** in the ignition lock.
- ▶ **To switch on:** press the **REAR** button. **ON** and **MODE** are shown in the automatic climate control display behind the **REAR** symbol. The **MODE** display goes out after three seconds. The display switches back to the standard display.

- ▶ **To switch off:** press the **REAR** button. **MODE** is shown in the display behind the **REAR** symbol.
- ▶ Press button **OFF**. **OFF** is shown in the display behind the **REAR** symbol.

Switching the rear-compartment climate control on/off using the rear control panel

3-zone automatic climate control

- ▶ Turn the SmartKey to position **2** in the ignition lock.
- ▶ Switch on automatic climate control using the front control panel.
- ▶ **To switch on:** press the **AUTO** button. The indicator lamp in the **AUTO** button lights up.
- ▶ **To switch off:** press the **OFF** button. The indicator lamp in the **OFF** button lights up.

Activating/deactivating the cooling with air dehumidification function

Important information

The cooling with air dehumidification function is only available when the engine is running. The air inside the vehicle is cooled and dehumidified according to the temperature selected.





WARNING

If you switch off the cooling function, the vehicle will not be cooled when weather conditions are warm. The windows can fog up more quickly. Window fogging may impair visibility and endanger you and others.

Condensation may drip from the underside of the vehicle when it is in cooling mode. This is normal and not a sign that there is a malfunction.

- i** The cooling with air dehumidification function uses refrigerant R134a. This coolant does not contain chlorofluorocarbons, and therefore does not damage the ozone layer.

Activating/deactivating

- !** If the cooling with air dehumidification does not switch on, it is possible that the climate control system has lost coolant. Have the cooling with air dehumidification checked at a qualified specialist workshop.
- ▶ **To activate:** press the  button. The indicator lamp in the  button lights up.
 - ▶ **To switch off:** press the  button. The indicator lamp in the  button goes out. The cooling with air dehumidification function has a delayed switch-off feature.

Problems with the cooling with air dehumidification function

If the indicator lamp in the  button does not go out when the function is activated, the cooling with air dehumidification function is deactivated due to a malfunction. You can no longer switch on the cooling with air dehumidification function.

- ▶ Consult a qualified specialist workshop.

Setting climate control to automatic





WARNING

If you switch off the cooling function, the vehicle will not be cooled when weather conditions are warm. The windows can fog up more quickly. Window fogging may impair visibility and endanger you and others.









In automatic mode, the set temperature is maintained automatically at a constant level. The system automatically regulates the temperature of the dispensed air, the airflow and the air distribution.

Automatic mode will achieve optimal operation if cooling with air dehumidification is also activated. If desired, cooling with air dehumidification can be deactivated.



Controlling the front climate control using the front control panel



- ▶ Turn the SmartKey to position **2** in the ignition lock.
- ▶ Set the desired temperature.
- ▶ **To activate:** press the  button. The indicator lamp in the  button lights up. Automatic air distribution and airflow are activated.
- ▶ **To deactivate:** press the  or  button. The indicator lamp in the  button goes out. Automatic airflow is deactivated and the airflow is controlled according to the level set. Automatic air distribution remains activated.

or



- ▶ Press the , , , , ,  or  button. The indicator lamp in the  button goes out. Automatic air distribution is deactivated. Air distribution is controlled according to the position set. Automatic airflow remains activated.

Controlling the rear-compartment climate control automatically using the rear control panel

- ▶ Turn the SmartKey to position **2** in the ignition lock.
- ▶ Switch on automatic climate control using the front control panel.
- ▶ Set the desired temperature.
- ▶ **To activate:** press the  button. The indicator lamp in the  button lights up. Automatic air distribution and airflow are activated.

- ▶ **To deactivate:** press the  or  button.
Automatic airflow is deactivated and the airflow is controlled according to the level set. Automatic air distribution remains activated.



or

- ▶ Press one of the  or  buttons.
Automatic air distribution is deactivated. Air distribution is controlled according to the position set. Automatic airflow remains activated.

Setting the temperature

2-zone automatic climate control

Different temperatures can be set for the driver's and front-passenger sides.

- ▶ Turn the SmartKey to position **2** in the ignition lock.
- ▶ **To increase/reduce:** turn controls  and  clockwise or counter-clockwise (▷ page 131).
Only change the temperature setting in small increments. Start at 72 °F (22 °C).

3-zone automatic climate control

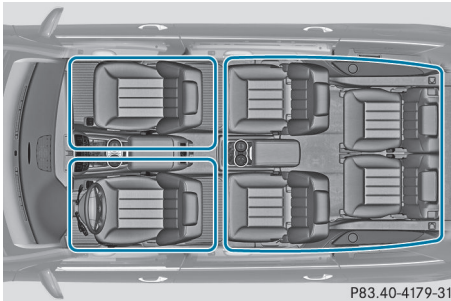

P83.40-4179-31



Automatic climate control climate zones

You can select different temperature settings for the driver's and front-passenger sides as well as for the rear compartment.

¹⁵ USA only.

¹⁶ Canada only.

- ▶ **To increase/reduce the front-compartment temperature using the front control unit:** turn the SmartKey in the ignition lock to position **2**.

- ▶ Turn controls  and  ¹⁵/ ¹⁶ clockwise or counter-clockwise (▷ page 132).

Only change the temperature setting in small increments. Start at 72 °F (22 °C).

USA only:

- ▶ **To increase/reduce the rear-compartment temperature using the front control unit:** turn the SmartKey in the ignition lock to position **2**.

- ▶ Press the  button.

- ▶ Turn control  clockwise or counter-clockwise (▷ page 132).

Only change the temperature setting in small increments. Start at 72 °F (22 °C).

Canada only:



- ▶ **To increase/reduce the rear-compartment temperature using the front control unit:** turn the SmartKey in the ignition lock to position **2**.

- ▶ Press the  button.

The display changes to rear-compartment climate control.



- ▶ Turn control  clockwise or counter-clockwise (▷ page 132).

Only change the temperature setting in small increments. Start at 72 °F (22 °C).

-  To return to the standard display, press the  button.

-  The rear display changes to the standard display automatically after three seconds.

- ▶ **To increase/reduce the temperature in the rear compartment using the rear control panel:** turn the SmartKey in the ignition lock to position **2**.

- ▶ Turn control  ¹⁵/ ¹⁶ clockwise or counter-clockwise (▷ page 132).







Only change the temperature setting in small increments. Start at 72 °F (22 °C).

Setting the air distribution



Air distribution settings

Automatic climate control: the air distribution can be set individually for the driver's and front-passenger sides.¹⁷







Front control unit:

-  Directs the airflow through the defroster vents
-  Directs the airflow through the defroster vents
-  Directs the airflow through the defroster vents
-  Directs the airflow through the footwell and side air vents
-  Directs the airflow through the footwell and side air vents
-  Directs the airflow through the center and side air vents
-  Directs the airflow through the center and side air vents



Rear control panel:

-  Directs the airflow through the rear-compartment air vents
-  Directs the airflow through the footwell air vents

Adjusting

- ▶ Turn the SmartKey to position **2** in the ignition lock.
- ▶ Press the  ,  ,  ,  ,  ,  or  button.

Setting the airflow



- ▶ Turn the SmartKey to position **2** in the ignition lock.
- ▶ **To increase/reduce:** press the  or  button.

Vehicles with Voice Control System: when the Voice Control System is switched on, the airflow is restricted to 50%. When command input is complete, the airflow is adjusted back to the previous setting.

Activating/deactivating the MONO function



The MONO function is only available with automatic climate control.¹⁸

You can use the MONO function to adopt the settings configured for temperature, air distribution and airflow on the driver's side for the front-passenger side and the rear compartment.

- ▶ Press the  button.
The indicator lamp in the  button lights up or goes out.

Defrosting the windshield

You can use this function to defrost the windshield or to defrost the inside of the windshield and the side windows.



- i** You should only select the defrosting function until the windshield is clear again.
- ▶ Turn the SmartKey to position **2** in the ignition lock.
- ▶ **To activate:** press the  button.
The indicator lamp in the  button lights up.

¹⁷ Canada only.

¹⁸ Canada only.

The climate control system switches to the following functions:

- cooling with air dehumidification on
- high airflow¹⁹
- high temperature¹⁹
- air distribution to the windshield and front side windows
- air-recirculation mode off

▶ **To switch off:** press the  button. The indicator lamp in the  button goes out. The previously selected settings come into effect again. The cooling with air dehumidification function remains on. Air-recirculation mode remains deactivated.

or

▶ Press the  button.

or

▶ Press the  button.

or



▶ Turn the temperature control clockwise or counter-clockwise.

or

▶ Press the  or  button.

Defrosting the windows

Windows fogged up on the inside





- ▶ Activate the cooling with air dehumidification function .
- ▶ Activate automatic mode .
- ▶ If the windows continue to fog up, activate the defrosting function (▶ page 138).

i You should only select this setting until the windshield is clear again.

¹⁹ Depending on the outside temperature.

²⁰ Canada only.

Windows fogged up on the outside

- ▶ Switch on the windshield wipers.
- ▶ Press the  / ²⁰ or  / ²⁰ air distribution button.

i You should only select this setting until the windshield is clear again.

Rear window defroster

Activating/deactivating

WARNING

Any accumulation of snow and ice should be removed from the rear window before driving. Visibility could otherwise be impaired, endangering you and others.

The rear window defroster has a high current draw. You should therefore switch it off as soon as the window is clear as it only switches off automatically after several minutes.

If the battery voltage is too low, the rear window defroster may switch off.

▶ Turn the SmartKey to position **2** in the ignition lock.

▶ Press the  button.

The indicator lamp in the  button lights up or goes out.

Problems with the rear window defroster

If the indicator lamp in the  rear window defroster button flashes, the on-board voltage is too low or the roof is open. The rear window defroster has deactivated itself prematurely or cannot be activated.

▶ Switch off any consumers that are not required, e.g. reading lamps or interior lighting. When the battery is sufficiently charged, the rear window defroster is activated again automatically.





Activating/deactivating air-recirculation mode

You can deactivate the flow of fresh air if unpleasant odors are entering the vehicle from outside. The air already inside the vehicle will then be recirculated.

The operation of air-recirculation mode is the same for all control panels.

WARNING





Fogged windows impair visibility, endangering you and others. If the windows begin to fog on the inside, switching off the air recirculation mode immediately should clear interior window fogging. If interior window fogging persists, make sure the air conditioning is activated, or press the  button.

- ▶ Turn the SmartKey to position **2** in the ignition lock.
 - ▶ **To activate:** press the  button. The indicator lamp in the  button lights up.
 - ▶ **To switch off:** press the  button. The indicator lamp in the  button goes out.
- i** Air-recirculation mode is activated automatically at high outside temperatures. When air-recirculation mode is activated automatically, the indicator lamp in the  button is not lit. Outside air is added after about 30 minutes.

- i** Air-recirculation mode deactivates automatically:
- after approximately five minutes if outside temperatures are less than about 41 °F (5 °C)
 - after approximately five minutes if cooling with air dehumidification is deactivated
 - after approximately 30 minutes if outside temperatures are over about 41 °F (5 °C)
- i** The air-recirculation mode is not deactivated automatically at outside temperatures above 79 °F (26 °C). After approximately 30 minutes, outside air is added.²¹

Activating/deactivating the residual heat function

It is possible to make use of the residual heat of the engine to continue heating the stationary vehicle for up to 30 minutes after the engine has been switched off. The heating time depends on the temperature that has been set.

- i** The blower will run at a low speed regardless of the airflow setting.
- i** If you activate the residual heat function at high temperatures, only the ventilation will be activated. The blower runs at medium speed.
- ▶ Turn the SmartKey to position **0** in the ignition lock or remove it.
 - ▶ **To activate:** press the  button. The indicator lamp in the  button lights up.
 - ▶ **To switch off:** press the  button. The indicator lamp in the  button goes out.

²¹ Vehicles with automatic climate control

- i** Residual heat is deactivated automatically:
- after about 30 minutes
 - when the ignition is switched on
 - if the battery voltage drops
 - if the coolant temperature is too low

Setting the air vents

Important safety notes

⚠ WARNING

When operating the climate control, the air that enters the passenger compartment through the air vents can be very hot or very cold (depending on the set temperature). This could cause burns or frostbite to unprotected skin in the immediate area of the air vents. Always keep sufficient distance between unprotected parts of the body and the air vents. If necessary, use the air distribution adjustment to direct the air to air vents in the vehicle interior that are not in the immediate area of unprotected skin.

In order to ensure the direct flow of fresh air through the air vents into the vehicle interior, please observe the following notes:

- keep the air intake grille on the hood free of blockages, such as ice, snow or leaves
 - never cover the air vents or air intake grille in the vehicle interior.
- i** For virtually draft-free ventilation, adjust the sliders of the air vents to the center position.

Setting the center air vents

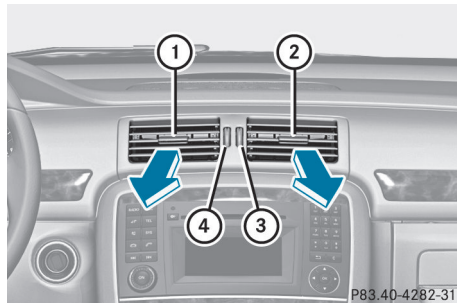

- ① Center air vent, left
- ② Center air vent, right
- ③ Center vent thumbwheel, right
- ④ Center vent thumbwheel, left

► **To open/close:** turn thumbwheels ③ and ④ up or down.

Setting the side air vents

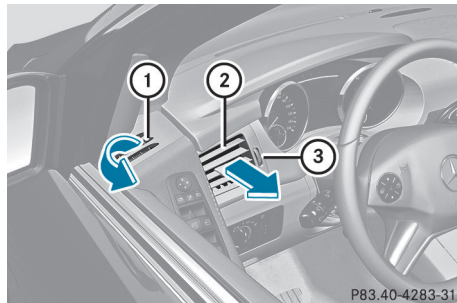

► **To open/close:** turn thumbwheel ③ up or down.

- i** Side window defroster vent ① is never completely shut, even if side air vent ② is shut.

Setting the rear-compartment air vents

Setting the center vents in the rear compartment

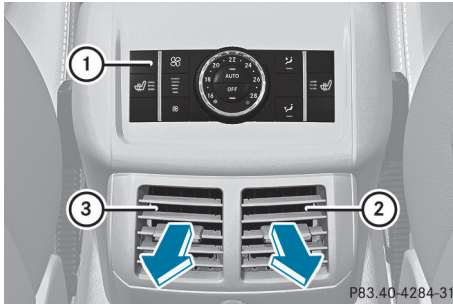

- ① Rear control panel²²
- ② Rear-compartment air vent, right
- ③ Rear-compartment air vent, left

When the climate control panel is switched on/off, the air supply through the rear-compartment air vents is also switched on/off.

Setting the B-pillar air vents

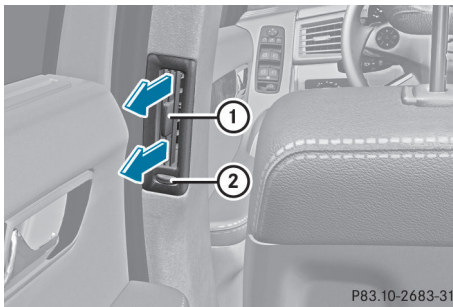

- ① B-pillar air vent
- ② Thumbwheel for B-pillar air vent

► **To open/close:** turn thumbwheel ② to the left or right.

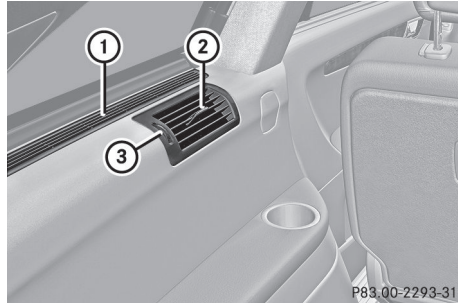

Side air vents in the rear compartment (third row of seats)

- ① Defroster vent
- ② B-pillar air vent
- ③ Thumbwheel for B-pillar air vent

► **To open/close:** turn thumbwheel ③ up or down.

²² Vehicles with automatic climate control.

Useful information	144
Breaking-in notes	144
Driving	144
Automatic transmission	150
Refueling	156
Parking	163
Driving tips	165
Driving systems	170
Trailer towing	191

Useful information

- i** This Operator's Manual describes all models and all standard and optional equipment of your vehicle available at the time of publication of the Operator's Manual. Country-specific differences are possible. Please note that your vehicle may not be equipped with all features described. This also applies to safety-related systems and functions.
- i** Please read the information on qualified specialist workshops (▷ page 24).

Breaking-in notes

The first 1000 miles (1500 km)

The more you look after the engine when it is new, the more satisfied you will be with its performance in the future.

- Drive at varying vehicle speeds and engine speeds for the first 1000 miles (1500 km) for this reason.
- Avoid overstraining the vehicle during this period, e.g. driving at full throttle.
- Change gear in good time, at the latest when the tachometer needle is $\frac{2}{3}$ of the way to the red area in the tachometer display.
- Do not manually shift to a lower gear to brake the vehicle.
- If possible, do not depress the accelerator pedal past the point of resistance (kickdown).
- Only select shift ranges **3**, **2** or **1** when driving slowly, e.g. in mountainous terrain.
- If possible, drive in drive program **E** for the first 1000 miles (1500 km).

After 1000 miles (1500 km), you can increase the engine speed gradually and bring the vehicle up to full speed.

- i** You should also observe these notes on running in if the engine or parts of the drive train on your vehicle have been replaced.

- i** Always observe the respective speed restrictions.

Driving

Important safety notes

WARNING

Make sure absolutely no objects are obstructing the pedals' range of movement. Keep the driver's footwell clear of all obstacles. If there are any floor mats or carpets in the footwell, make sure the pedals still have sufficient clearance.

During sudden driving or braking maneuvers the objects could get caught between the pedals. You could then no longer brake or accelerate. This could lead to accidents and injury.

WARNING

On slippery road surfaces, never downshift in order to obtain braking action. This could result in drive wheel slip and reduced vehicle control. Your vehicle's ABS will not prevent this type of loss of control.

WARNING

It is dangerous to shift the automatic transmission out of parking position **P** or neutral position **N** if the engine speed is higher than idle speed. If your foot is not firmly on the brake pedal, the vehicle could accelerate quickly forward or in reverse. You could lose control of the vehicle and hit someone or something. Only shift into gear when the engine is idling normally and when your right foot is firmly on the brake pedal.

- !** Warm up the engine quickly. Do not use the engine's full performance until it has reached operating temperature.

Only shift the automatic transmission to the desired drive position when the vehicle is stationary.

Where possible, avoid spinning the drive wheels when pulling away on slippery roads. You could otherwise damage the drive train.

SmartKey positions

SmartKey

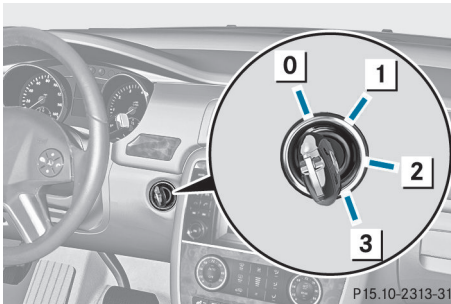

- 0 To remove the SmartKey
- 1 Power supply for some consumers, such as the windshield wipers
- 2 Ignition (power supply for all consumers) and drive position
- 3 To start the engine

i The SmartKey can be turned in the ignition lock even if it is not the correct SmartKey for the vehicle. The ignition is not switched on. The engine cannot be started.

KEYLESS-GO

General information

Vehicles with KEYLESS-GO are equipped with a SmartKey featuring an integrated KEYLESS-GO function and a detachable Start/Stop button.

The Start/Stop button must be inserted into the ignition lock and the SmartKey must be in the vehicle.

Pressing the Start/Stop button several times in succession corresponds to the different SmartKey positions in the ignition lock. This is only the case if you are not depressing the brake pedal.

If you depress the brake pedal and press the Start/Stop button, the engine starts immediately.

The Start/Stop button can be removed from the ignition lock. Then, you can insert the SmartKey into the ignition lock.

- i** You do not have to remove the Start/Stop button from the ignition lock when you leave the vehicle. However, you should always take the SmartKey with you when leaving the vehicle. The vehicle can be started with the Start/Stop button and the electrical equipment can be operated while the SmartKey is in the vehicle.

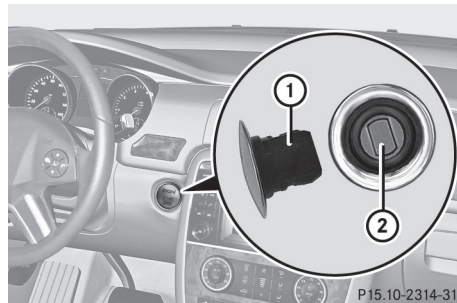

- 1 Start/Stop button
- 2 Ignition lock

► Insert Start/Stop button 1 into ignition lock 2.

- i** When you insert Start/Stop button 1 into ignition lock 2, the system requires a detection time of approximately two seconds before you can use Start/Stop button 1.

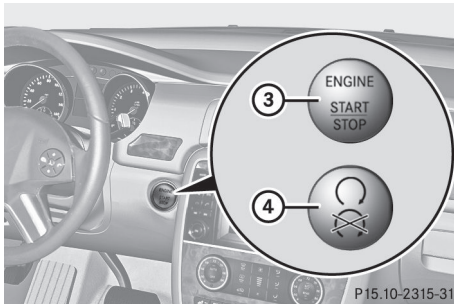

Start/Stop button

③ USA only

④ Canada only

► Position **0**: if Start/Stop button ① has not yet been pressed, this corresponds to the SmartKey being removed from the ignition.

► Position **1**: press Start/Stop button ①. You can now activate the windshield wipers, for example.

i If you then open the driver's door when in this position, the power supply is deactivated.

► Position **2** (ignition): press Start/Stop button ① twice.

i If you press Start/Stop button ① once when in this position and the driver's door is open, the power supply is deactivated again.

As soon as the ignition is switched on, all the indicator lamps in the instrument cluster light up. If an indicator lamp does not go out after the engine is started or if it lights up while the vehicle is in motion, see (▷ page 239).

Starting the engine

Important safety notes

WARNING

Inhalation of exhaust gas is hazardous to your health. All exhaust gas contains carbon monoxide (CO), and inhaling it can cause unconsciousness and possible death.

Do not run the engine in confined areas (such as a garage) which are not properly ventilated. If you think that exhaust gas fumes are entering the vehicle while driving, have the cause determined and corrected immediately. If you must drive under these conditions, drive only with at least one window fully open at all times.

i Do not depress the accelerator pedal when starting the engine.

i **Vehicles with a gasoline engine:** the catalytic converter is preheated for up to 30 seconds after a cold start. During this time, the engine sound may be different.

Automatic transmission

► Shift the transmission to position **P**. The transmission position display in the multifunction display shows **P**.

i You can also start the engine when the transmission is in position **N**.

Starting procedure with the SmartKey

i To start the engine using the SmartKey instead of KEYLESS-GO, pull the Start/Stop button out of the ignition lock.

► **To start a gasoline engine:** turn the SmartKey to position **3** in the ignition lock (▷ page 145) and release it as soon as the engine is running.

► **To start a diesel engine:** turn the SmartKey to position **2** in the ignition lock (▷ page 145). The  preglow indicator lamp in the instrument cluster lights up.



► When the  preglow indicator lamp goes out, turn the SmartKey to position **3** (▷ page 145) and release it as soon as the engine is running.

i You can start the engine without preglow if the engine is warm.

Using KEYLESS-GO to start the engine

WARNING

As long as the SmartKey is in your vehicle, the vehicle can be started. Therefore, never leave children unattended in the vehicle, as they could otherwise accidentally start the engine. When leaving the vehicle, always take the SmartKey with you and lock the vehicle. Do not leave children unattended in the vehicle, or with access to an unlocked vehicle. A child's unsupervised access to a vehicle could result in an accident and/or serious personal injury.

-  The Start/Stop button can be used to start the vehicle without inserting the SmartKey into the ignition lock. The Start/Stop button must be inserted into the ignition lock and the SmartKey must be in the vehicle.
 - ▶ Depress the brake pedal and keep it depressed.
 - ▶ **To start a gasoline engine:** press the Start/Stop button (▷ page 145) once. The engine starts.
 - ▶ **To start a diesel engine:** press the Start/Stop button (▷ page 145) once. Preglow is activated and the engine starts.
-  If the engine is warm, the preglow time is shortened.





Pulling away

Automatic transmission

WARNING

It is dangerous to shift the automatic transmission out of parking position **P** or neutral position **N** if the engine speed is higher than idle speed. If your foot is not firmly on the brake pedal, the vehicle could accelerate quickly forward or in reverse. You could lose control of the vehicle and hit someone or something. Only shift into gear

when the engine is idling normally and when your right foot is firmly on the brake pedal.

-  It is only possible to shift the transmission from position **P** to the desired position if you depress the brake pedal. Only then is the parking lock released. If you do not depress the brake pedal, you can move the DIRECT SELECT lever but the parking lock remains engaged.
 - ▶ Depress the brake pedal and keep it depressed.
 - ▶ Shift the transmission to position **D** or **R**.
 - ▶ Release the parking brake (▷ page 164).
 - ▶ Release the brake pedal.
 - ▶ Carefully depress the accelerator pedal.
-  If a warning tone sounds and the **Release Park. Brake** message appears in the multifunction display, the parking brake is still applied. Release the parking brake.
-  The vehicle locks centrally once you have pulled away. The locking knobs in the doors drop down.
 - You can open the doors from the inside at any time.
 - You can also deactivate the automatic locking feature (▷ page 208).
-  Upshifts take place at higher engine speeds after a cold start. This helps the catalytic converter to reach its operating temperature more quickly.

Hill start assist

Hill start assist helps you when pulling away forwards or in reverse on an uphill gradient. It holds the vehicle for a short time after you have removed your foot from the brake pedal. This gives you enough time to move your foot from the brake pedal to the accelerator pedal and depress it before the vehicle begins to roll.

 **WARNING**

Never leave the vehicle when it is held by hill start assist. After approximately one second, hill start assist will no longer brake your vehicle and it could roll away.

- ▶ Take your foot off the brake pedal.
- ▶  Once you have taken your foot off the brake pedal, the vehicle is held for around one second.
- ▶ Pull away.

Hill start assist will not function if:

- you are pulling away on a level road or a downhill gradient.
- the transmission is in position **N**.
- the parking brake is applied.
- ESP® is malfunctioning.

Problems with the engine

Problem	Possible causes/consequences and ► Solutions
<p>The engine does not start. The starter motor can be heard.</p>	<ul style="list-style-type: none"> • There is a malfunction in the engine electronics. • There is a malfunction in the fuel supply. <p>► Before attempting to start the engine again, turn the SmartKey in the ignition back to position 0 or press the Start/Stop button repeatedly until all indicator lamps in the instrument cluster go out.</p> <p>► Try to start the engine again (▷ page 146). Avoid excessively long and frequent attempts to start the engine as these will drain the battery.</p> <p>If the engine does not start after several attempts:</p> <p>► Consult a qualified specialist workshop, e.g. an authorized Mercedes-Benz Center.</p>
<p>The engine does not start. You cannot hear the starter motor.</p>	<p>The on-board voltage is too low because the battery is too weak or discharged.</p> <p>► Jump-start the vehicle (▷ page 313).</p> <p>If the engine does not start despite attempts to jump-start it:</p> <p>► Consult a qualified specialist workshop, e.g. an authorized Mercedes-Benz Center.</p> <p>The starter motor was exposed to a thermal load that was too high.</p> <p>► Allow the starter motor to cool down for approximately two minutes.</p> <p>► Try to start the engine again.</p> <p>If the engine still does not start:</p> <p>► Consult a qualified specialist workshop, e.g. an authorized Mercedes-Benz Center.</p>

Problem	Possible causes/consequences and ► Solutions
Vehicles with a gasoline engine: The engine is not running smoothly and is misfiring.	There is a malfunction in the engine electronics or a mechanical component of the engine management system. <ul style="list-style-type: none"> ► Only depress the accelerator pedal slightly. ► Have the cause rectified immediately at a qualified specialist workshop, e.g. an authorized Mercedes-Benz Center. Otherwise, non-combusted fuel may get into the catalytic converter and damage it.
The coolant temperature gauge shows a value above 248 °F (120 °C).	The coolant level is too low. The coolant is too hot and the engine is no longer being cooled sufficiently. <ul style="list-style-type: none"> ► Stop as soon as possible and allow the engine and the coolant to cool down. ► Check the coolant level (► page 285). Observe the warning notes as you do so and add coolant if necessary.

Automatic transmission

Important safety notes

⚠ WARNING

It is dangerous to shift the automatic transmission out of parking position **P** or neutral position **N** if the engine speed is higher than idle speed. If your foot is not firmly on the brake pedal, the vehicle could accelerate quickly forward or in reverse. You could lose control of the vehicle and hit someone or something. Only shift into gear when the engine is idling normally and when your right foot is firmly on the brake pedal.

⚠ WARNING

Keep in mind that turning off the engine alone only will shift the automatic transmission into neutral position **N** automatically.

Always shift the automatic transmission into park position **P** before turning off the engine. Otherwise the vehicle could roll away which could result in an accident and/or serious personal injury.

DIRECT SELECT lever

Overview of transmission positions

The DIRECT SELECT lever is on the right of the steering column.

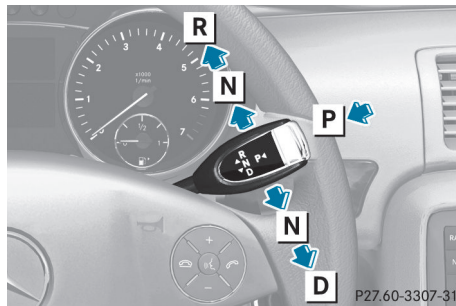

P Park position with parking lock

R Reverse gear

N Neutral

D Drive

i The DIRECT SELECT lever always returns to its original position. The current transmission position **P**, **R**, **N** or **D** appears in the transmission position display (► page 151) in the multifunction display.

Engaging park position P

- ▶ Push the DIRECT SELECT lever in the direction of arrow **P**.

i The automatic transmission shifts automatically into park position **P** if you open the driver's door when the vehicle is stationary or driving at very low speed, and the transmission is in position **D** or **R**.

! If the engine speed is too high or the vehicle is moving, do not shift the automatic transmission directly from **D** to **R**, from **R** to **D** or directly to **P**. The automatic transmission could otherwise be damaged.

Engaging reverse gear R

- !** Only shift the automatic transmission to **R** when the vehicle is stationary.
- ▶ When the vehicle is stationary, depress the brake pedal.
- ▶ Push the DIRECT SELECT lever up past the first point of resistance.

Shifting to neutral N

- ▶ When the vehicle is stationary, depress the brake pedal.
- ▶ Push the DIRECT SELECT lever up or down to the first point of resistance.

If the engine has been switched off, the automatic transmission automatically switches to **N**.

Remaining in neutral N

If the automatic transmission is to remain in neutral **N**, e.g. for washing the vehicle in car washes with a towing device, please observe the following instructions:

WARNING

When leaving the SmartKey in the starter switch, do not leave children unattended in the vehicle. It is possible for children to switch on the ignition which could result in unsupervised use of vehicle equipment.

Unsupervised use of vehicle equipment could result in an accident and/or serious personal injury.

Using the SmartKey:

- make sure that the ignition is switched on.
- when the vehicle is stationary, depress the brake pedal and keep it depressed.
- shift to neutral **N**.
- release the brake pedal.
- if applied, release the parking brake.
- switch off the ignition and leave the SmartKey in the ignition lock.

Using KEYLESS-GO:

- make sure that the ignition is switched on.
- when the vehicle is stationary, depress the brake pedal and keep it depressed.
- engage park position **P**.
- release the brake pedal.
- remove the Start/Stop button from the ignition lock.
- insert the SmartKey into the ignition lock.
- switch on the ignition.
- depress the brake pedal and keep it depressed.
- shift to neutral **N**.
- release the brake pedal.
- if applied, release the parking brake.
- switch off the ignition and leave the SmartKey in the ignition lock.

Shifting to transmission position D

- ▶ When the vehicle is stationary, depress the brake pedal.
- ▶ Push the DIRECT SELECT lever down past the first point of resistance.

Transmission position display

The current transmission position is shown in the multifunction display.

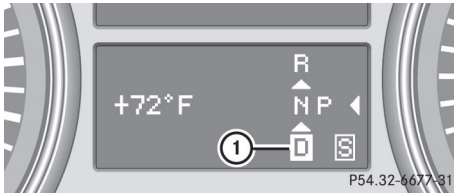

① Transmission position

i The arrows in the transmission position display show how and into which transmission positions you can change using the DIRECT SELECT lever.

Transmission positions

P Park position

Do not shift the transmission into position **P** (> page 163) unless the vehicle is stationary. The parking lock should not be used as a brake when parking. In addition to engaging the parking lock, you must always apply the parking brake to secure the vehicle.

If the vehicle electronics are malfunctioning, the transmission may be locked in position **P**.

Have the vehicle electronics checked at a qualified specialist workshop, e.g. an authorized Mercedes-Benz Center, immediately.

R Reverse gear

Only shift the transmission to **R** when the vehicle is stationary.

N Neutral

Do not shift the transmission to **N** while driving. The transmission could otherwise be damaged.

No power is transmitted from the engine to the drive wheels.

Releasing the brakes will allow you to move the vehicle freely, e.g. to push it or tow it.

If ESP[®] is deactivated or faulty: only shift the transmission to position **N** if the vehicle is in danger of skidding, e.g. on icy roads.

! Rolling in neutral **N** can damage the drive train.

D Drive

The automatic transmission changes gear automatically. All forward gears are available.

Changing gear

The automatic transmission shifts to the individual gears automatically when it is in transmission position **D**. This automatic gearshifting behavior is determined by:

- a shift range restriction, if selected
- the selected drive program
 - **E/S** (> page 153)
- the position of the accelerator pedal
- the road speed

Driving tips

Kickdown

Use kickdown for maximum acceleration.

- ▶ **Vehicles for USA:** fully depress the accelerator pedal.
The transmission shifts to a lower gear depending on the engine speed.
- ▶ **Vehicles for Canada:** depress the accelerator pedal beyond the pressure point.
The transmission shifts to a lower gear depending on the engine speed.

Rocking the vehicle free

Rocking the vehicle free by shifting back and forth between transmission positions **D** and **R** can help to free a vehicle that has become stuck in mud or snow. The engine management system of the vehicle limits shifting back and forth between transmission positions **D** and **R** to a maximum speed of 5 mph (9 km/h). To shift back and forth between transmission positions **D** and **R**, move the selector lever up and down beyond the pressure point.

Working on the vehicle

WARNING

When working on the vehicle, engage the parking brake and shift the automatic transmission into park position **P**. Otherwise the vehicle could roll away which could result in an accident and/or serious personal injury.

Trailer towing

- ▶ When towing a trailer and driving downhill, shift to the lower gear if the automatic transmission constantly shifts between two gears.
- ▶ Engaging a lower gear and reducing the speed reduces the risk of the engine overheating.

Program selector button

General information

The program selector button allows you to choose between different driving characteristics.

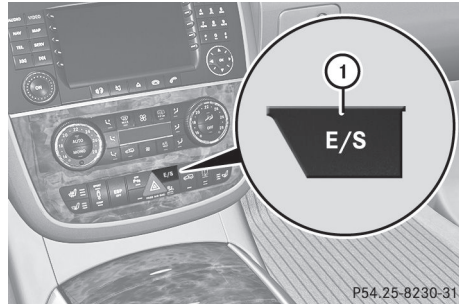

Program selector button

E Economy	Comfortable, economical driving
S Sport	Sporty driving style

- i** For further information on the automatic drive program, see (▷ page 154).
- ▶ Press program selector button ① repeatedly until the letter for the desired gearshift program appears in the multifunction display.

Steering wheel paddle shifters



- ① Left-hand steering wheel paddle shifter
- ② Right-hand steering wheel paddle shifter

You can restrict or derestrict the shift range by using the steering wheel paddle shifters.

Automatic drive program

Drive program **E** is characterized by the following:

- the vehicle pulling away more gently in forward and reverse gears, unless the accelerator pedal is depressed fully
- increased sensitivity. This improves driving stability on slippery road surfaces, for example
- the automatic transmission shifting up sooner. This results in the vehicle being driven at lower engine speeds and the wheels being less likely to spin

Drive program **S** is characterized by the following:

- sporty engine settings
- the vehicle pulling away in first gear
- the automatic transmission shifting up later
- the fuel consumption possibly being higher as a result of the later automatic transmission shift points

Shift ranges

Introduction

When the automatic transmission is in position **D**, it is possible to restrict or derestrict the shift range (▷ page 154). The shift range selected is shown in the multifunction display. The automatic transmission shifts only as far as the selected gear.

Driving situations

- 3** You can use the engine's braking effect.

- 2** To use the braking effect of the engine on downhill gradients and for driving:

- on steep mountain roads
- in mountainous terrain
- in arduous conditions

- 1** To use the braking effect of the engine on extremely steep downhill gradients and on long downhill stretches

Restricting the shift range

- ▶ Pull the left-hand steering wheel paddle shifter.
The automatic transmission shifts down one gear and restricts the shift range to the relevant gear.

- i** If the engine exceeds the maximum engine speed when shifting down, the automatic transmission protects against engine damage by not shifting down.
- i** If the maximum engine speed for the shift range is reached and you continue to accelerate, the automatic transmission shifts up in order to prevent the engine from overrevving, even if the shift range is restricted.

Derestricting the shift range

- ▶ Pull the right-hand steering wheel paddle shifter.
The shift range is derestricted.

Clearing the shift range restriction

- ▶ Pull and hold the right-hand steering wheel paddle shifter until **D** is shown again in the multifunction display.
The automatic transmission shifts from the current shift range directly to **D**.

Selecting the ideal shift range

- ▶ Pull the left-hand steering wheel paddle shifter and hold it in position. The automatic transmission shifts to the gear which allows optimum acceleration and deceleration. To do this, the automatic transmission shifts down one or more gears.

Problems with the transmission

Problem	Possible causes/consequences and ► Solutions
The transmission has problems shifting gear.	The transmission is losing oil. ► Have the transmission checked at a qualified specialist workshop, e.g. an authorized Mercedes-Benz Center, immediately.
The acceleration ability is deteriorating. The transmission no longer changes gear.	The transmission is in emergency mode. It is only possible to shift into second gear and reverse gear. ► Stop the vehicle. ► Shift the transmission to position P . ► Switch off the engine. ► Wait at least 10 seconds before restarting the engine. ► Shift the transmission to position D or R . If D is selected, the transmission shifts into second gear; if R is selected, the transmission shifts into reverse gear. ► Have the transmission checked at a qualified specialist workshop, e.g. an authorized Mercedes-Benz Center, immediately.

Transfer case

The vehicle has permanent 4-wheel drive (4MATIC). Power is always transmitted to both axles.

- ❗ Performance tests may only be carried out on a 2-axle dynamometer. The brake system or transfer case could otherwise be damaged. Contact a qualified specialist workshop for a performance test. Mercedes-Benz recommends that you use an authorized Mercedes-Benz Center for this purpose.
- ❗ If the parking brake is being tested on a brake dynamometer, the ignition must be switched off (SmartKey or Start/Stop button in position **0** or **1**), as ESP® will otherwise automatically intervene. The test must last a maximum of 10 seconds. The brake system could otherwise be damaged.

Refueling

Important safety notes

⚠ WARNING

Gasoline and diesel fuels are highly flammable and poisonous. They burn violently and can cause serious injury.

Never allow sparks, flames or smoking materials near gasoline or diesel fuel!

Turn off the engine before refueling.

Whenever you are around gasoline or diesel fuel, avoid inhaling fumes and any skin or clothing contact. Extinguish all smoking materials.

Direct skin contact with fuels and the inhalation of fuel vapors are damaging your health.

⚠ WARNING

Overfilling of the fuel tank may create pressure in the system which could cause a gas discharge. This could cause the gasoline

to spray back out when removing the fuel pump nozzle, which could cause personal injury.

WARNING

Do not fill diesel tanks with gasoline. Do not mix diesel fuel with gasoline. Otherwise the fuel system and engine could be damaged. In addition, the vehicle could catch fire.

- !** Do not use gasoline to refuel vehicles with a diesel engine. Do not use diesel to refuel vehicles with a gasoline engine. Even a small quantity of the wrong fuel will damage the fuel system and engine.
- !** Do not switch on the ignition if you accidentally refuel with the wrong fuel. Otherwise, the fuel will enter the fuel lines. Notify a qualified specialist workshop and have the fuel tank and fuel lines drained completely.

Gasoline

Fuel grade

- !** You should only refuel with unleaded premium-grade gasoline as this avoids damaging the catalytic converter.
If engine running problems are apparent, have the cause checked immediately and repaired. Excess unburned fuel can otherwise enter the catalytic converter, leading to overheating and possibly causing a fire.
- !** Use a filter when refueling from a fuel can. Otherwise, the fuel lines and/or injection system could be blocked by particles from the fuel can.
- i** Only refuel with premium-grade unleaded gasoline with a specified minimum octane number of 91 (average value of 96 RON/86 MON).
Usually, you will find information about the fuel grade on the pump. If you cannot find

the label on the gasoline pump, ask the gas station staff.

You can find more information under “Fuel” (▷ page 356), or by contacting an authorized Mercedes-Benz Service Center or visiting <http://www.mbusa.com> (USA only).

Diesel

Fuel grade

- !** Only refuel with ULTRA-LOW SULFUR DIESEL FUEL (ULSD, 15 ppm SULFUR MAXIMUM). Using other diesel fuels could result in increased wear and damage to the engine and/or exhaust system.
Never refuel with marine diesel or heating oil.
Do not mix these fuels with diesel fuels and do not use any special additives, as this may result in damage.
- !** Use a filter when adding fuel from a fuel can. Otherwise, the fuel lines and/or the fuel injection system could be blocked by particles from the fuel can.
- i** Usually, you will find information about the fuel grade on the pump. If you cannot find the label on the gasoline pump, ask the gas station staff.
You can find more information under “Fuel” (▷ page 356), or by contacting an authorized Mercedes-Benz Service Center or visiting <http://www.mbusa.com> (USA only).

Low outside temperatures

- !** Do not use gasoline to refuel vehicles with a diesel engine. Never mix diesel with gasoline or kerosene, as this may result in damage to the engine or fuel system.

Diesel fuel with improved cold flow properties is available during the winter months. Further information on fuel properties can be

obtained from oil companies, e.g. at gas stations.

Refueling

Fuel filler flap

The fuel filler flap is unlocked or locked automatically when you open or close the vehicle with the SmartKey or using KEYLESS-GO.

The position of the fuel filler cap is displayed in the instrument cluster . The arrow next to the filling pump indicates the side of the vehicle.

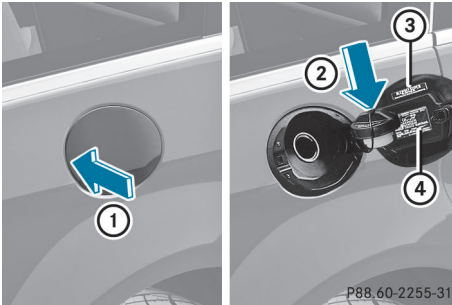

- ① To open the fuel filler flap
- ② To insert the fuel filler cap
- ③ Fuel type
- ④ Tire pressure table



Opening

- ▶ Switch off the engine.
- ▶ Remove the SmartKey from the ignition lock.
KEYLESS-GO: open the driver's door. This switches the ignition to position **0**, which corresponds to having removed the SmartKey. The driver's door can be closed again.
- ▶ Press the fuel filler flap in the direction of arrow ①.
The fuel filler flap opens slightly.
- ▶ Open the fuel filler flap.

- ▶ Turn the fuel filler cap counter-clockwise and remove it.
- ▶ Insert the fuel filler cap into the holder bracket on the inside of filler flap ②.
- ▶ Completely insert the pump nozzle into the filler neck and refuel.
- ▶ Only fill the tank until the pump nozzle switches off.

! Overfilling the fuel tank could damage the fuel system.

Closing

- ▶ Replace the fuel filler cap and turn it clockwise. The fuel filler cap audibly engages.
 - ▶ Close the fuel filler flap.
- i** If you drive with the fuel filler cap open, the reserve fuel warning lamp flashes. In addition, the  (USA only) or  (Canada only) Check Engine warning lamp may light up. A message appears in the multifunction display (> page 228).
For further information on warning and indicator lamps in the instrument cluster, see (> page 244).
- i** Close the fuel filler flap before locking the vehicle. A locking pin otherwise prevents the fuel filler flap from closing after the vehicle has been locked.

Fuel filler flap emergency release

WARNING

Avoid contact with the vehicle walls as they may contain sharp edges. Otherwise, you could injure yourself while releasing the fuel filler flap.

The emergency release is located in the cargo compartment behind the side trim on the right-hand side, when viewed in the direction of travel.

- ▶ Open the tailgate.
- ▶ Open the right-hand side trim panel (▷ page 123).

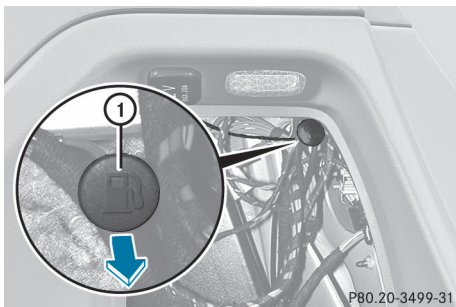

- ▶ Pull emergency release ① in the direction of the arrow.
The fuel filler flap is unlocked.
- ▶ Open the fuel filler flap.

Problems with fuel and the fuel tank	
Problem	Possible causes/consequences and ► Solutions
Fuel is leaking from the vehicle.	<p> Risk of explosion or fire</p> <p>The fuel line or the fuel tank is defective.</p> <ul style="list-style-type: none"> ► Turn the SmartKey to position 0(▷ page 145) in the ignition lock immediately and remove it. ► Do not restart the engine under any circumstances. ► Consult a qualified specialist workshop.
The fuel filler flap cannot be opened.	<p>The fuel filler flap is not unlocked.</p> <p>or</p> <p>The SmartKey battery is discharged.</p> <ul style="list-style-type: none"> ► Unlock the vehicle using the mechanical key (▷ page 75). ► Open the tailgate. ► Manually unlock the fuel filler flap using the emergency release (▷ page 158).
	<p>The fuel filler flap is unlocked, but the opening mechanism is jammed.</p> <ul style="list-style-type: none"> ► Manually unlock the fuel filler flap using the emergency release (▷ page 158). ► Consult a qualified specialist workshop.
The engine will not start.	<p>The fuel tank of a vehicle with a diesel engine has been run completely dry.</p> <ul style="list-style-type: none"> ► Refuel the vehicle with at least 5.3 US qt (5 liters) of diesel. ► Turn the ignition on for at least 10 seconds (▷ page 145). ► Start the engine continuously for up to 10 seconds until it runs smoothly. <p>If the engine does not start:</p> <ul style="list-style-type: none"> ► Turn the ignition on again for approximately 10 seconds (▷ page 145). ► Start the engine again continuously for up to 10 seconds until it runs smoothly. <p>If the engine does not start after three attempts:</p> <ul style="list-style-type: none"> ► Consult a qualified specialist workshop.

DEF**Important notes on use**

To function properly, BlueTEC exhaust gas aftertreatment must be operated with the reducing agent DEF. Adding DEF is one of the tasks performed during maintenance. Under normal operating conditions, a tank of DEF lasts until the next service due date.

When the DEF supply has almost run out, the **Check Additive See Operator's Manual** message is shown in the multifunction display.

When the DEF supply sinks to a minimum level, the **Remaining Starts: 16** message is shown in the multifunction display.

When the **Remaining Starts: 16** message is shown in the multifunction display, you can start the engine 16 more times. If DEF is not added, it is then not possible to start the engine again. Fill the DEF tank with about 1 gal (3.8 l) DEF or have the DEF tank refilled at a qualified specialist workshop.

Use the special DEF refill bottle when filling between maintenance intervals. Contact an authorized Mercedes-Benz Center with any questions or, if necessary, contact Roadside Assistance (▷ page 22).

Further information about BlueTEC exhaust gas aftertreatment and DEF is available at any authorized Mercedes-Benz Center.

Adding DEF**⚠ WARNING**

Make sure

- DEF does not come into contact with skin, eyes, or clothing
- to keep DEF out of the reach of children

If you and/or others have come into contact with DEF:

- If DEF has gotten into contact with eyes, flush with plenty of water immediately and seek medical help.
- Clean affected skin immediately with plenty of water.
- If DEF was swallowed, rinse mouth immediately with plenty of water and drink plenty of water. Consult a physician.

⚠ WARNING

If you open the DEF tank cap at high temperatures, ammonia vapors can be released.

Ammonia vapors have a pungent odor and are particularly irritating to:

- skin
- mucous membranes
- eyes

You may experience a burning sensation in your eyes, nose and throat, as well as coughing and watering of the eyes.

Do not inhale any ammonia vapors that may be released. Only refill the DEF tank in well ventilated areas.

- ❗ Only use DEF that complies with ISO 2224 1. Do not add any special additives to DEF and do not thin DEF with water. This could destroy the BlueTEC exhaust gas aftertreatment.

If the outside temperature is lower than -11 °C, damage may occur when topping up. If DEF is frozen and there is an active warning indicator, topping up may not be possible. Park the vehicle in a warmer place, e.g. in a garage, until DEF has become fluid again. Filling is then possible again. Alternatively, have the DEF tank refilled at a qualified specialist workshop.

- ❗ Rinse surfaces that have come into contact with DEF immediately with water or remove DEF using a damp cloth and cold water. If the DEF has already crystallized,

use a sponge and cold water to clean it. DEF residues crystallize after time and contaminate the affected surfaces.

! DEF is not a fuel additive and must not be added to the fuel tank. If DEF is added to the fuel tank, this can lead to engine damage.

i If you are adding between maintenance intervals, add approximately 1 gallon (3.8 l) of DEF to the DEF tank. One gallon (3.8 l) of DEF is approximately 2 DEF refill bottles.

For further information on DEF, see:
(▷ page 357).

The DEF filler neck is under the cargo compartment floor.

- ▶ Switch off the ignition.
- ▶ Open the tailgate.
- ▶ Lift up the trunk floor (▷ page 296).

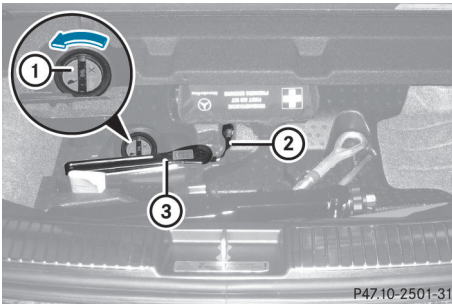

- ▶ Remove lug wrench (2) and ratchet wrench (3) if applicable.
- ▶ Turn DEF cap (1) counter-clockwise and remove it.

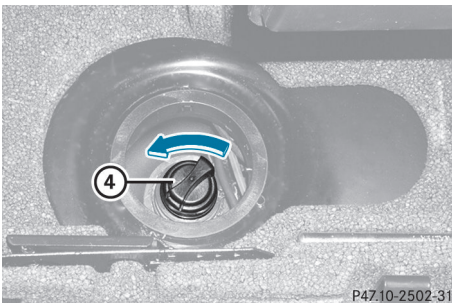

- ▶ Turn DEF filler cap (4) counter-clockwise and open it. Filler cap (4) is secured with a plastic strap.

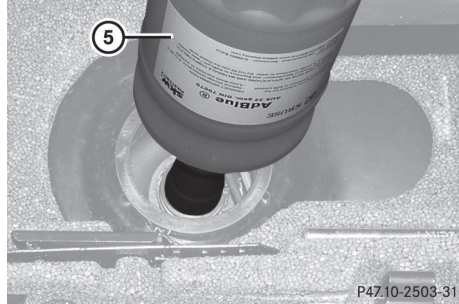

- ▶ Unscrew the covering cap from DEF refill bottle (5).
- ▶ Place DEF refill bottle (5) on the filler neck as shown and screw on clockwise hand-tight.

! Only screw on the DEF refill bottle hand-tight. It could otherwise be damaged.

- ▶ Press DEF refill bottle (5) down. The DEF tank is filled. This may take up to one minute.

i If the DEF refill bottle is no longer pressed down, the filling process stops and the partially emptied bottle can be removed.

- ▶ Release DEF refill bottle (5).
- ▶ Turn DEF refill bottle (5) counter-clockwise and remove it.
- ▶ Place DEF filler cap (4) on the filler neck and turn it clockwise.

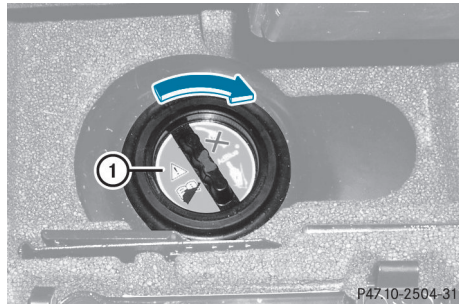

- ▶ Insert DEF cap ① as shown and turn it clockwise as far as it will go.
- ▶ Stow lug wrench ② and ratchet wrench ③ again.
- ▶ Fold the cargo compartment floor down.
- ▶ Close the tailgate.
- ▶ Drive at a speed above 10 mph (16 km/h). The **Check Additive See Operator's Manual** message goes out after approximately one minute.

- i** If the **Check Additive See Operator's Manual** message remains shown in the multifunction display, add an additional bottle of DEF.
- i** Then, have the DEF supply checked at a qualified specialist workshop and completely refilled if necessary.

Parking

Important safety notes

WARNING

Do not park this vehicle in areas where combustible materials can come into contact with the hot exhaust system. Do not park the vehicle on dry grassland or harvested grain fields. Combustible materials, such as grass, hay or leaves could be ignited by the hot exhaust system and cause a vehicle fire.

Unintended vehicle movement can cause serious personal injury or damage to the vehicle or the vehicle drivetrain. To reduce such risks, always do the following before turning off the engine and leaving the vehicle:

- keep your right foot on the brake pedal.
- engage the parking brake.
- shift the automatic transmission to park position **P**.
- slowly release the brake pedal.
- when parked on an incline, always turn the front wheels towards the road curb.

- turn the SmartKey in the ignition lock to position **0** and remove the SmartKey from the ignition lock, or press the KEYLESS-GO Start/Stop button.
- take the SmartKey with you and lock the vehicle when leaving.

Switching off the engine

Important safety notes

WARNING

Do not turn off the engine before the vehicle has come to a complete stop. With the engine not running, there is no power assistance for the brake and steering systems. In this case, it is important to keep in mind that a considerably higher degree of effort is necessary to brake and steer the vehicle.

WARNING

Keep in mind that turning off the engine alone only will shift the automatic transmission into neutral position **N** automatically.

Always shift the automatic transmission into park position **P** before turning off the engine. Otherwise the vehicle could roll away which could result in an accident and/or serious personal injury.

- i** If you cannot turn off the engine as described here, see "Engine emergency stop" (▷ page 319).

Vehicles with automatic transmission

- ▶ Apply the parking brake firmly.
- ▶ Shift the transmission to position **P**.

Using the SmartKey

- ▶ Turn the SmartKey to position **0** in the ignition lock and remove it. The immobilizer is activated.
- i** If you turn off the engine with the SmartKey and then remove it from the ignition lock or open a front door, the

automatic transmission shifts to **P** automatically.

Using KEYLESS-GO

- ▶ Press the Start/Stop button (▷ page 145). The engine stops and all the indicator lamps in the instrument cluster go out.

i When the driver's door is closed, this corresponds to SmartKey position **1**. When the driver's door is open, it corresponds to SmartKey position **0** or "SmartKey removed".

i If you use the Start/Stop button to switch off the engine, the automatic transmission shifts to **N** automatically. If you then open the driver's or front-passenger door, the automatic transmission shifts to **P**.

i In an emergency, the engine can be turned off while the vehicle is in motion by pressing and holding the Start/Stop button for three seconds.

Parking brake

WARNING

Engaging the parking brake while the vehicle is in motion can cause the rear wheels to lock up. You could lose control of the vehicle and cause an accident. In addition, the vehicle's brake lights do not light up when the parking brake is engaged.

WARNING

When leaving the vehicle, always remove the SmartKey from the starter switch, take it with you, and lock the vehicle. Do not leave children unattended in the vehicle, or with access to an unlocked vehicle. Children could release the parking brake and/or shift the automatic transmission out of park position **P**, either of which could result in an accident and/or serious personal injury.

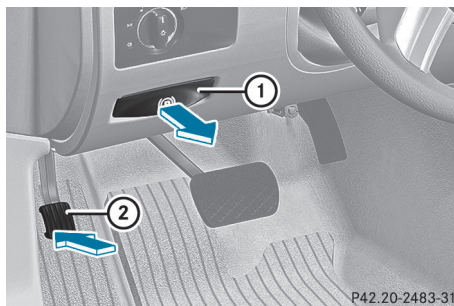

P42.20-2483-31

▶ **To apply:** depress parking brake **2** firmly. When the engine is running, the **BRAKE** (USA only) or  (Canada only) indicator lamp lights up in the instrument cluster.

▶ **To release:** depress the brake pedal and keep it depressed.

▶ Pull release handle **1**.

When the ignition is switched on or the engine is running, the **BRAKE** (USA only) or  (Canada only) indicator lamp goes out in the instrument cluster.

Parking the vehicle for a long period

If you leave the vehicle parked for longer than four weeks, the battery may be damaged by exhaustive discharge.

▶ Connect a trickle charger.

i You can obtain information about trickle chargers from a qualified specialist workshop, e.g. an authorized Mercedes-Benz Center.

If you leave the vehicle parked for longer than six weeks, the vehicle may suffer damage as a result of lack of use.

▶ Visit a qualified specialist workshop and seek advice.

Driving tips

General driving tips

Important safety notes

WARNING

Always remember that you must concentrate primarily on driving the vehicle. The driver's concentration must always be directed primarily at road traffic. For your own safety and that of others, we recommend that you stop the vehicle at a safe place and in accordance with the traffic conditions before making or accepting a phone call.

Comply with all legal requirements if you use the telephone while driving. Use the hands-free system and only use the telephone when road, weather and traffic conditions permit. In some jurisdictions, it is forbidden for drivers to use mobile phones while driving.

Only operate COMAND (Cockpit Management and Data System) in compliance with all legal requirements and when the road, weather and traffic conditions permit. You may otherwise not be able to observe the traffic conditions, endangering yourself and others.

Remember that your vehicle covers a distance of 44 feet (approximately 14 m) a second when it is traveling at only 30 mph (approximately 50 km/h).

Drive sensibly – save fuel

Observe the following tips to save fuel:

- ▶ The tires should always be inflated to the recommended tire pressure.
- ▶ Remove unnecessary loads.
- ▶ Remove roof carriers when they are not needed.
- ▶ Warm up the engine at low engine speeds.
- ▶ Avoid frequent acceleration or braking.
- ▶ Have all maintenance work carried out as indicated by the service intervals in the Service Booklet or by the service interval display.

Fuel consumption also increases when driving in cold weather, in stop-and-go traffic and in mountainous terrain.

Drinking and driving

WARNING

Drinking and driving and/or taking drugs and driving are very dangerous combinations. Even a small amount of alcohol or drugs can affect your reflexes, perceptions and judgment.

The possibility of a serious or even fatal accident are greatly increased when you drink or take drugs and drive.

Do not drink or take drugs and drive or allow anyone to drive who has been drinking or taking drugs.

Pedals

WARNING

Make sure absolutely no objects are obstructing the pedals' range of movement. Keep the driver's footwell clear of all obstacles. If there are any floor mats or carpets in the footwell, make sure that the pedals still have sufficient clearance.

During sudden driving or braking maneuvers, the objects could get caught between the pedals. You could then no longer brake or accelerate. This could lead to accidents and injury.

Rolling with the engine switched off

WARNING

There is no power assistance for the steering and the brake when the engine is not running. Steering and braking requires significantly more effort and you could lose control of the vehicle and cause an accident as a result.

Do not turn off the engine while the vehicle is in motion.

Exhaust check

WARNING

Inhalation of exhaust gas is hazardous to your health. All exhaust gas contains carbon monoxide (CO), and inhaling it can cause unconsciousness and possible death.

Do not run the engine in confined areas (such as a garage) which are not properly ventilated. If you think that exhaust gas fumes are entering the vehicle while driving, have the cause determined and corrected immediately. If you must drive under these conditions, drive only with at least one window fully open at all times.

Certain engine systems are designed to keep the level of poisonous components in exhaust fumes within legal limits.

These systems only work at peak efficiency when they are maintained exactly in accordance with the manufacturer's specifications. For this reason, all work on the engine must be carried out only by qualified and authorized Mercedes-Benz technicians.

The engine settings must not be changed in any circumstances. Furthermore, all specific service work must be carried out at regular intervals and in accordance with the Mercedes-Benz service requirements. Details can be found in the Service Booklet.

Engine oil

Vehicles with a diesel particle filter:

If the vehicle is mostly driven for short distances, it is possible that malfunctions may occur during the automatic cleaning of the diesel particle filter. This can lead to engine damage. Therefore, if you frequently drive short distances, make sure to drive on highways or inter-urban roads for 20 minutes at least every 310 miles (500 km).

Brakes

Important safety notes

WARNING

On slippery road surfaces, never downshift in order to obtain braking action. This could result in drive wheel slip and reduced vehicle control. Your vehicle's ABS will not prevent this type of loss of control.

WARNING

Make sure that you do not endanger other road users when you apply the brakes.

Downhill gradients

 On long and steep gradients, you must reduce the load on the brakes by shifting early to a lower gear. This allows you to take advantage of the engine braking effect and helps avoid overheating and excessive wear of the brakes.

When you take advantage of the engine braking effect, a drive wheel may not turn for some time, e.g. on a slippery road surface. This could cause damage to the drive train. This type of damage is not covered by the Mercedes-Benz warranty.

Heavy and light loads

WARNING

Depressing the brake pedal constantly results in excessive and premature wear to the brake pads.

It may also cause the brakes to overheat, seriously impairing their effectiveness. It may then not be possible to stop the vehicle in sufficient time to avoid an accident.

If the brakes have been subjected to a heavy load, do not stop the vehicle immediately, but drive on for a short while. This allows the airflow to cool the brakes more quickly.

Wet roads

WARNING

After driving in heavy rain for some time without applying the brakes or through water deep enough to wet brake components, the first braking action may be somewhat reduced. You have to depress the brake pedal more firmly. Maintain a safe distance from vehicles in front.

After driving on a wet road or having the vehicle washed, brake firmly while paying attention to the traffic conditions. This will warm up the brake discs, thereby drying them more quickly and protecting them against corrosion.

Limited braking performance on salt treated roads

WARNING

The layer of salt on the brake discs and the brake pads/linings may cause a delay in the braking effect, resulting in a significantly longer braking distance, which could lead to an accident.

To avoid this danger, you should:

- occasionally brake carefully, without putting other road users at risk, when you are driving on salted roads. This helps to remove any salt that may have started to build up on the brake discs and the brake pads/linings.
- maintain a greater distance to the vehicle ahead and drive with particular care.
- carefully apply the brakes at the end of a trip and immediately after commencing a new trip, so that salt residues are removed from the brake discs.

Servicing the brakes

 If the brake warning lamp lights up in the instrument cluster and you hear a warning tone even though the parking brake has been released, the brake fluid level may be

too low. Observe additional warning messages in the multifunction display.

The brake fluid level may be too low due to brake pad wear or leaking brake lines.

Have the brake system checked immediately. Have this work carried out at an authorized Mercedes-Benz Center.

All checks and maintenance work on the brake system must be carried out at a qualified specialist workshop. This work should be carried out at an authorized Mercedes-Benz Center.

Have the brake pads and brake fluid installed or replaced at a qualified specialist workshop, e.g. an authorized Mercedes-Benz Center.

WARNING

If other than recommended brake pads are installed, or other than recommended brake fluid is used, the braking properties of the vehicle can be degraded to an extent that safe braking is substantially impaired. This could result in an accident.

 A function or performance test should only be carried out on a 2-axle dynamometer. If you are planning to have the vehicle tested on such a dynamometer, contact an authorized Mercedes-Benz Center to obtain further information first. Otherwise, you could damage the drive train or the brake system.

 As the ESP[®] system operates automatically, the engine and the ignition must be switched off (SmartKey in position **0** or **1** in the ignition lock or Start/Stop button in position **0** or **1**) while the parking brake is being tested on a brake dynamometer (maximum 10 seconds). Braking maneuvers triggered automatically by ESP[®] may seriously damage the brake system.

If your brake system is subject only to moderate loads, you should test the functionality of your brakes at regular intervals by pressing firmly on the brake pedal

at high speeds. This improves the grip of the brake pads.

WARNING

Make sure that you do not endanger other road users when you apply the brakes.

You can find a description of Brake Assist (BAS) on [▷ page 65](#).

Parking brake

If you drive on wet roads or dirt-covered surfaces, road salt and/or dirt could get into the parking brake.

In order to prevent corrosion and a reduction in the braking power of the parking brake, observe the following:

- Gently depress the parking brake from time to time before beginning the journey.
- Drive a distance of approximately 110 yds (100 m) with a maximum speed of 12 mph (20 km/h).

WARNING

While performing this procedure please assure that the vehicle is stopped before applying the parking brake. Otherwise the rear wheels could lock up. You could lose control of the vehicle and cause an accident. In addition, the vehicle's brake lights do not light up when the parking brake is engaged. Make sure not to endanger any other road users when you engage the parking brake.

Driving on wet roads

Hydroplaning

If water has accumulated to a certain depth on the road surface, there is a danger of hydroplaning occurring, even if:

- you drive at low speeds.
- the tires have adequate tread depth.

For this reason, in the event of heavy rain or in conditions in which hydroplaning can occur you must drive in the following manner:

- reduce your speed
- avoid ruts
- brake carefully

Driving on flooded roads

 Do not drive through flooded areas. Check the depth of any water before driving through it. Drive slowly through standing water. Otherwise, water may enter the vehicle interior or the engine compartment. This can damage the electronic components in the engine or the automatic transmission. Water can also be drawn in by the engine's air suction nozzles and this can cause engine damage.

Do not allow water to enter the passenger compartment or the engine compartment. If you have to drive through a stretch of standing water, please be aware the following:

- the depth of the water must not exceed 10 inches (25 cm) for calm water
- you should drive no faster than at walking pace.

 **For vehicles with AIRMATIC package:** if you have set the raised level before driving through a stretch of standing water, the maximum water depth is 12 inches (30 cm).

Winter driving

Important safety notes

WARNING

If the vehicle becomes trapped in snow, ensure that snow is kept away from the exhaust pipe and from around the vehicle as long as the engine is running. Otherwise, poisonous carbon monoxide (CO) may enter

the vehicle, resulting in loss of consciousness and even death.

To assure sufficient fresh air ventilation, open a window slightly on the side of the vehicle not facing the wind.

At the onset of winter, have your vehicle winterproofed at a qualified specialist workshop, e.g. at an authorized Mercedes-Benz Center.

- i** Vehicles with a diesel engine: do not cover the radiator, e.g. with a protective cover. The measuring function of the Onboard Diagnosis System may otherwise provide inaccurate values. Some of these values are required by law and must therefore always be accurate.

Winter tires

At temperatures below 45 °F(+7 °C), use winter tires or all-season tires. Both types of tire are identified by the M+S marking.

Only winter tires bearing the  snowflake symbol in addition to the M+S marking provide the best possible grip in wintry road conditions. Only these tires will allow driving safety systems such as ABS and ESP® to function optimally in winter, as these tires have been designed specifically for driving on snow.

Use M+S tires of the same make and tread on all wheels to maintain safe handling characteristics.

WARNING

M+S tires with a tread depth of less than $\frac{1}{6}$ inch (4 mm) must be replaced immediately. They are no longer suitable for use in winter.

Always observe the maximum permissible speed specified for the M+S tires you have mounted.

Once you have mounted the winter tires:

- ▶ Check the tire pressures (▷ page 329).
- ▶ Restart the tire pressure monitor (▷ page 331).

WARNING

If you use your spare wheel when M+S tires are mounted on the other wheels, be aware that the difference in tire characteristics impairs cornering ability and reduces driving stability. Adapt your driving style accordingly.

Have the spare wheel replaced by a normal wheel with an M+S tire at the nearest Mercedes-Benz Center.

Snow chains

For safety reasons, Mercedes-Benz recommends that you only use snow chains which have been specially approved for your vehicle by Mercedes-Benz, or are of a corresponding standard of quality.

- !** Vehicles with the Adaptive Damping System (ADS): do not drive in ADS SPORT mode if snow chains have been mounted. The vehicle may otherwise be damaged.

- !** There is not enough space for snow chains on some wheel sizes. Observe the information under "Tires and wheels" in the "Technical Data" section to avoid damage to the vehicle or the wheels.

- Only use snow chains when driving on roads completely covered by snow. Do not exceed the maximum permissible speed of 30 mph (50 km/h). Remove the snow chains as soon as possible when you are no longer driving on snow-covered roads.
- Local regulations may restrict the use of snow chains. Applicable regulations must be observed if you wish to mount snow chains.
- Snow chains must not be mounted on emergency spare wheels.

If you intend to mount snow chains, please bear the following points in mind:

- you may not attach snow chains to all wheel-tire combinations; see the information under "Wheel and tire combinations" in the "Wheels and tires" section.
- mount snow chains only in pairs and only to the rear wheels. Observe the manufacturer's installation instructions.

! If snow chains are mounted on the front wheels, the snow chains could grind against the bodywork or components of the chassis. This could result in damage to the vehicle or the tires.

! **Vehicles with steel wheels:** if you wish to install snow chains to steel wheels, make sure that you remove the respective wheels' hubcaps first. The hubcaps may otherwise be damaged.

i You may wish to deactivate ESP® (▷ page 66) when pulling away with snow chains mounted. This way you can allow the wheels to spin in a controlled manner, achieving an increased driving force (cutting action).

Slippery road surfaces

WARNING

The outside temperature indicator is not designed to serve as an ice-warning device and is therefore unsuitable for that purpose. Indicated temperatures just above the freezing point do not guarantee that the road surface is free of ice. The road may still be icy, especially in wooded areas or on bridges.

WARNING

On slippery road surfaces, never downshift in order to obtain braking action. This could result in drive wheel slip and reduced vehicle control. Your vehicle's ABS will not prevent this type of loss of control.

Drive particularly carefully on slippery road surfaces. Avoid sudden acceleration, steering and braking maneuvers. Do not use cruise control.

If the vehicle threatens to skid or cannot be stopped when moving at low speed:

► Shift the transmission to position **N**.

i For more information on driving with snow chains, see (▷ page 169).

WARNING

Make sure that you do not endanger other road users when you apply the brakes.

Driving systems

Cruise control

Important safety notes

Cruise control maintains a constant road speed for you. It brakes automatically in order to avoid exceeding the set speed. On long and steep downhill gradients, especially if the vehicle is laden or towing a trailer, you must select shift range **1**, **2** or **3** in good time. By doing so, you will make use of the braking effect of the engine, which relieves the load on the brake system and prevents the brakes from overheating and wearing too quickly.

Use cruise control only if road and traffic conditions make it appropriate to maintain a steady speed for a prolonged period. You can set any road speed above 20 mph (30 km/h).

WARNING

The cruise control is a convenience system designed to assist the driver during vehicle operation. The driver is and must always remain responsible for the vehicle's speed and for safe brake operation.

Only use the cruise control if the road, traffic, and weather conditions make it advisable to travel at a constant speed.

- The use of the cruise control can be dangerous on winding roads or in heavy traffic because conditions do not allow safe driving at a constant speed.
- The use of the cruise control can be dangerous on slippery roads. Rapid changes in tire traction can result in wheel spin and loss of control.
- Deactivate the cruise control when driving in fog.

The "Resume" function should only be operated if the driver is fully aware of the previously set speed and wishes to resume this particular preset speed.

WARNING

When cruise control brakes, the brake pedal is pulled back (i.e. operated automatically). The area around the pedal must not be blocked by obstacles:

- Do not place any objects in the footwell.
- Ensure that floor mats and carpets are fixed securely. In particular, do not place several floor mats on top of one another.
- Do not place your foot under the brake pedal, as it could become trapped.

Non-compliance could lead you to cause an accident in which you and/or others could be seriously injured.

Cruise control lever

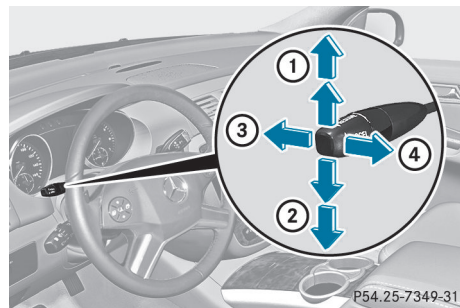

- ① To store the current speed or a higher speed
- ② To store the current speed or a lower speed
- ③ To deactivate cruise control
- ④ To store the current speed or to call up the last stored speed

When you activate cruise control, the stored speed is shown in the status indicator of the multifunction display:

- Canada only: e.g.  90 Km/h

Storing and maintaining the current speed

You can store the current speed if you are driving faster than 20 mph (30 km/h).

- ▶ Accelerate the vehicle to the desired speed.
- ▶ Briefly press the cruise control lever up ① or down ② to the pressure point.
- ▶ Remove your foot from the accelerator pedal.
Cruise control is activated. The vehicle automatically maintains the stored speed.

- i** Cruise control may be unable to maintain the stored speed on uphill gradients. The stored speed is resumed when the gradient evens out. Cruise control maintains the stored speed on downhill gradients by automatically applying the brakes.

Storing the current speed or calling up the last stored speed

WARNING

The set speed stored in memory should only be set again if prevailing road conditions and legal speed limits permit. Possible acceleration or deceleration differences arising from returning to the preset speed could cause an accident and/or serious injury to you and others.

- ▶ Briefly pull the cruise control lever towards you ④.
- ▶ Remove your foot from the accelerator pedal.
The first time cruise control is activated, it stores the current speed or regulates the speed of the vehicle to the previously stored speed.

Setting a speed

WARNING

Keep in mind that it may take a brief moment until the vehicle has made the necessary adjustments.

Increase or decrease the set vehicle speed to a value that the prevailing road conditions and legal speed limits permit. Otherwise, sudden and unexpected acceleration or deceleration of the vehicle could cause an accident and/or serious injury to you and others.

- ▶ Press the cruise control lever to the pressure point, up ① for a higher speed or down ② for a lower speed.
 - ▶ Keep the cruise control lever pressed until the desired speed is reached.
 - ▶ Release the cruise control lever.
The new speed is stored.
-  Cruise control is not deactivated if you depress the accelerator pedal. For example, if you accelerate briefly to overtake, cruise control adjusts the

vehicle's speed to the last speed stored after you have finished overtaking.

Making adjustments in 1 mph (Canada: 1 km/h) increments

- ▶ Briefly press the cruise control lever to the pressure point, up ① for a higher speed or down ② for a lower speed.
The last speed stored is increased or reduced.

Making adjustments in 5 mph (Canada: 10 km/h) increments

- ▶ Briefly press the cruise control lever beyond the pressure point, up ① for a higher speed or down ② for a lower speed.
The last speed stored is increased or reduced.

Deactivating cruise control

There are several ways to deactivate cruise control:

- ▶ Briefly press the cruise control lever forwards ③.

or

- ▶ Brake.

Cruise control is automatically deactivated if:

- you depress the parking brake.
- you are driving below 20 mph (30 km/h).
- ESP® intervenes or you deactivate ESP®.
- you shift the transmission to position **N** while driving.

If cruise control is deactivated, you will hear a warning tone. You will see the **Cruise Control Off** message in the multifunction display for approximately five seconds.

-  The last speed stored is cleared when you switch off the engine.

DISTRONIC**Important safety notes**

DISTRONIC regulates the speed and automatically helps you maintain the distance to the vehicle detected in front. It brakes automatically in order to avoid exceeding the set speed.

On long and steep downhill gradients, especially if the vehicle is laden or towing a trailer, you must select shift range **1, 2 or 3** in good time. By doing so, you will make use of the braking effect of the engine, which relieves the load on the brake system and prevents the brakes from overheating and wearing too quickly.

If a slower-moving vehicle is detected in front, DISTRONIC causes your vehicle to brake and maintain the preset distance to the vehicle in front.

⚠ WARNING

The Distronic requires familiarity with its operational characteristics. We strongly recommend that you review the following information carefully before operating the system.

⚠ WARNING

When DISTRONIC brakes, the brake pedal is pulled back (i.e. operated automatically). The area around the pedal must not be blocked by obstacles:

- do not place any objects in the footwell.
- ensure that floor mats and carpets are fixed securely. In particular, do not place several floor mats on top of one another.
- do not place your foot under the brake pedal, as it could become trapped.

Non-compliance could lead you to cause an accident in which you and/or others could be seriously injured.

⚠ WARNING

The Distronic is a convenience system. Its speed adjustment reduction capability is

intended to make cruise control more effective and usable when traffic speeds vary. It is not however, intended to, nor does it, replace the need for extreme care.

The responsibility for the vehicle's speed, distance to the preceding vehicle and, most importantly, brake operation to ensure a safe stopping distance, always remains with the driver.

The Distronic cannot take street and traffic conditions into account. Complex driving situations are not always fully recognized by the Distronic. This could result in wrong or missing distance warnings.

If there is no vehicle driving in front of you, DISTRONIC functions like cruise control at a speed range between 20 mph (30 km/h) and 120 mph (200 km/h). If a vehicle is driving in front of you, it functions at a speed range between 0 mph (0 km/h) and 120 mph (200 km/h).

Do not use DISTRONIC while driving on roads with steep gradients.

⚠ WARNING

DISTRONIC distance control is not a substitute for the driver's active involvement. It does not react to pedestrians or stationary objects and cannot detect or predict the road's course and the movements of the vehicles in front.

DISTRONIC can only brake using 40% of the vehicle's maximum possible braking force.

The driver must always pay attention to road, weather and traffic conditions. He must steer, brake and drive the vehicle so that he maintains control over it.

High-frequency sources such as toll stations, velocity measurement systems, etc. may cause DISTRONIC to malfunction.

⚠ WARNING

The Distronic cannot take road and traffic conditions into account. Only use the Distronic if the road, weather and traffic

conditions make it advisable to travel at a constant speed.

 **WARNING**

Use of the DISTRONIC can be dangerous on slippery roads. Rapid changes in tire traction can result in wheel spin and loss of control.

The DISTRONIC does not function in adverse sight and distance conditions. Do not use the DISTRONIC during conditions of fog, heavy rain, snow or sleet.

 **WARNING**

The DISTRONIC cannot take weather conditions into account. Switch off the DISTRONIC or do not switch it on if:

- roads are slippery or covered with snow or ice. The wheels could lose traction while braking or accelerating, and the vehicle could skid.
- the DISTRONIC system sensor cover is dirty or visibility is diminished due to snow, rain or fog, for example. The distance control system functionality could be impaired.

Always pay attention to surrounding traffic conditions even while the DISTRONIC is switched on. Otherwise, you may not be able to recognize dangerous situations until it is too late. This could cause an accident in which you and/or others could be injured.

 **WARNING**

The "Resume" function should only be operated if the driver is fully aware of the previously set speed and wishes to resume this particular preset speed.

 **WARNING**

Close attention to road and traffic conditions is imperative at all times, regardless of whether or not the DISTRONIC is activated.

Use of the DISTRONIC can be dangerous on winding roads or in heavy traffic because conditions do not allow safe driving at a constant speed.

The DISTRONIC will not react to stationary objects in the roadway (e.g. a stopped vehicle in a traffic jam or a disabled vehicle). The DISTRONIC will also not respond to oncoming vehicles.

Switch off the DISTRONIC

- when changing from the left to the right lane if vehicles are moving more slowly in the left lane
- when entering a turn lane or highway off ramp
- in complex driving situations, such as in highway construction zones

In these situations, the DISTRONIC will continue to maintain the set speed unless deactivated.

The DISTRONIC is designed and intended only to maintain a set speed and keep a set distance from moving objects in front of it.

 This device has been approved by the FCC as a "Vehicular Radar System". The radar sensor is intended for use in an automotive radar system only. Removal, tampering, or altering of the device will void any warranties, and is not permitted by the FCC. Do not tamper with, alter, or use in any non-approved way.

Any unauthorized modification to this device could void the user's authority to operate the equipment.

Cruise control lever

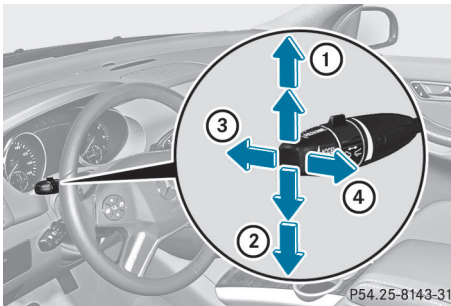

- ① To store the current speed or a higher speed
- ② To store the current speed or a lower speed
- ③ To deactivate DISTRONIC
- ④ To store the current speed or to call up the last stored speed

Switching on DISTRONIC, storing and maintaining the current speed

WARNING

The vehicle can be braked when DISTRONIC is activated. For this reason, deactivate DISTRONIC if the vehicle is to be set in motion by other means (e.g. in a car wash or by towing).

You can activate DISTRONIC in the following circumstances:

- if the engine has been started and you have been driving for up to two minutes
- while driving, except if you brake
- if the parking brake is not applied
- if ESP® is activated
- if the transmission is in position **D**

Activating while driving

When driving at speeds below 20 mph (30 km/h), you can only activate DISTRONIC PLUS if the vehicle in front has been detected and is shown in the multifunction display. If the vehicle in front is not shown in the multifunction display and is no longer being

detected, because it has changed lanes, for example, DISTRONIC is deactivated and you hear a warning tone.

- ▶ Briefly pull the cruise control lever towards you ④ or press it up ① or down ② to the pressure point. DISTRONIC is activated.
- ▶ Keep the cruise control lever pressed up ① or down ② until the desired speed is set.
- ▶ Remove your foot from the accelerator pedal. Your vehicle adapts its speed to that of the vehicle in front, but only up to the desired stored speed.

i You can use the cruise control lever to set the stored speed and the thumbwheel on the cruise control lever to set the specified minimum distance (▷ page 177).

i If you do not fully release the accelerator pedal, the **DISTRONIC Override** message appears in the multifunction display. The set distance to a slower-moving vehicle in front will then not be maintained. You will be driving at the speed you determine by the position of the accelerator pedal.

Driving

If there is no vehicle in front, DISTRONIC operates in the same way as cruise control.

If a slower-moving vehicle is detected in front, DISTRONIC causes your vehicle to brake and maintain the preset distance to the vehicle in front.

If DISTRONIC detects a faster-moving vehicle in front, it increases the driving speed, but only up to the desired speed you have stored.

WARNING

If you depress the brake pedal, DISTRONIC is deactivated. DISTRONIC will then no longer brake your vehicle. In such cases, control the distance from vehicles traveling in front with the brake alone. You could otherwise cause an accident and thereby injure yourself and others. The driver remains fully responsible

for the vehicle's distance from other vehicles, the speed being driven and for braking in good time.

Stopping

WARNING

DISTRONIC must never be operated, activated or deactivated by a passenger or from outside the vehicle.

If DISTRONIC detects that the vehicle in front is stopping, it brakes your vehicle until it is stationary.

-  Depending on the specified minimum distance, your vehicle will come to a standstill at a sufficient distance behind the vehicle in front. The specified minimum distance is set using the thumbwheel on the cruise-control lever.

DISTRONIC is deactivated automatically when stopping:

- on flat stretches of road or on downhill gradients when the vehicle is stationary
- while the vehicle is still moving on uphill gradients, to prevent the vehicle from unexpectedly rolling back when DISTRONIC is deactivated

If DISTRONIC is deactivated, you will hear a warning tone.

- ▶ To prevent the vehicle from rolling away, apply the foot brake or parking brake.

Setting a speed

WARNING

Keep in mind that it may take a brief moment until the vehicle has made the necessary adjustments.

Increase or decrease the set vehicle speed to a value that the prevailing road conditions and legal speed limits permit. Otherwise, sudden and unexpected acceleration or deceleration of the vehicle could cause an accident and/or serious injury to you and others.

- ▶ Press the cruise control lever to the pressure point, up ① for a higher speed or down ② for a lower speed.
- ▶ Keep the cruise control lever pressed until the desired speed is reached.
- ▶ Release the cruise control lever. The new speed is stored. DISTRONIC is activated and adjusts the vehicle's speed to the new speed stored.

Making adjustments in 1 mph (Canada: 1 km/h) increments

- ▶ Briefly press the cruise control lever to the pressure point, up ① for a higher speed or down ② for a lower speed. The last speed stored is increased or reduced.

Making adjustments in 5 mph (Canada: 10 km/h) increments

- ▶ Briefly press the cruise control lever beyond the pressure point, up ① for a higher speed or down ② for a lower speed. The last speed stored is increased or reduced.

Storing the current speed or calling up the last stored speed

WARNING

The set speed stored in memory should only be set again if prevailing road conditions and legal speed limits permit. Possible acceleration or deceleration differences arising from returning to the preset speed could cause an accident and/or serious injury to you and others.

- ▶ Briefly pull the cruise control lever towards you ④.
- ▶ Remove your foot from the accelerator pedal. DISTRONIC is activated and accepts the current speed if it is activated for the first

time, or adjusts the vehicle's speed to the last speed stored.

Setting the specified minimum distance

You can set the specified minimum distance for DISTRONIC by varying the time span between one and two seconds. This time span determines the distance that DISTRONIC should maintain from the vehicle in front, depending on the road speed. You can see this distance in the multifunction display (▷ page 178).

WARNING

It is up to the driver to exercise discretion to select the appropriate setting given road conditions, traffic, driver's preferred driving style and applicable laws and driving recommendations for safe following distance.

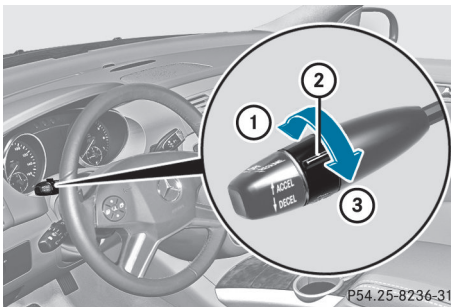

- ▶ **To increase:** turn thumbwheel ② towards ③.

DISTRONIC then maintains a greater distance between your vehicle and the vehicle in front.

- ▶ **To decrease:** turn thumbwheel ② towards ①.

DISTRONIC then maintains a shorter distance between your vehicle and the vehicle in front.

- i** Make sure that you maintain the minimum distance to the vehicle in front as required by law. Adjust the distance to the vehicle in front if necessary.

DISTRONIC displays in the speedometer



When DISTRONIC is activated, one or two segments in the set speed range light up.

- i** For design reasons, the speed displayed in the speedometer may differ slightly from the speed set for DISTRONIC.

If DISTRONIC detects a vehicle in front, segments ② between the speed of the vehicle in front ① and stored speed ③ light up.

WARNING

An intermittent warning sounds and the distance warning lamp  in the instrument cluster is illuminated if the DISTRONIC system calculates that the distance to the vehicle ahead and your vehicle's current speed indicate that the DISTRONIC will not be capable of slowing the vehicle sufficiently to maintain the preset following distance, which creates a danger of a collision.

Immediately brake the vehicle to increase your distance to the preceding vehicle. The warning sound is intended as a final caution in which you should intercede with your own braking inputs to avoid a potentially dangerous situation. Do not wait for the operation of the warning signal to intercede with your own braking. This will result in potentially dangerous emergency braking which will not always result in an impact being avoided.

Tailgating increases the risk of an accident.

⚠ WARNING

DISTRONIC brakes your vehicle with a maximum deceleration of 13 ft/s² (4 m/s²). This corresponds to approximately 40% of your vehicle's maximum possible braking power.



You must apply the brakes yourself to avoid a collision. DISTRONIC brakes the vehicle to restore the set distance to the vehicle in front or to restore the set speed. In this case, the brake pedal is depressed automatically, which can be seen by a movement of the brake pedal.

Always keep the driver's footwell clear, including the area under the brake pedal.

Objects in this area may impair pedal movement and cause the DISTRONIC braking function to malfunction.

Do not place your foot under the brake pedal – your foot could become caught.

DISTRONIC displays in the multifunction display

- ▶ Press the  or  button to select the **DISTRONIC** menu (▶ page 201).

Display when DISTRONIC is deactivated

When DISTRONIC is deactivated, you will see the following in the multifunction display:

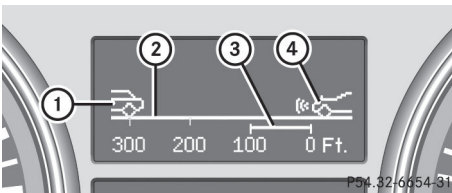

- ① Vehicle in front, if detected
- ② Distance indicator, displaying current distance to the vehicle in front
- ③ Specified minimum distance to the vehicle in front, adjustable
- ④ Own vehicle

Display when DISTRONIC is activated

After this time, you will see the following in the multifunction display while DISTRONIC is activated:

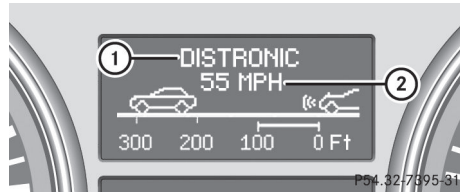

- ① DISTRONIC activated
- ② Stored speed

When activating DISTRONIC and when setting the speed, stored speed ② appears for around five seconds.

After approximately five seconds, current saved speed ② is displayed in the multifunction display's status indicator **DTR XXX Miles**.

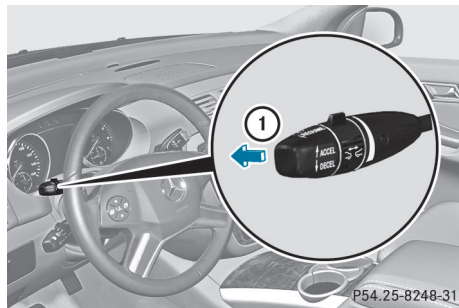
Deactivating DISTRONIC

There are several ways to deactivate DISTRONIC:

- ▶ Briefly press the cruise control lever forwards ①.
- or
- ▶ Brake.
- ⓘ The last speed stored remains stored until you switch off the engine.
 - ⓘ DISTRONIC is not deactivated if you depress the accelerator pedal. If you accelerate to overtake, DISTRONIC adjusts

the vehicle's speed to the last speed stored after you have finished overtaking.

DISTRONIC is automatically deactivated if:

- you apply the parking brake.
- you are driving slower than 20 mph (25 km/h) and there is no vehicle in front, or if the vehicle in front is no longer detected.
- ESP® intervenes or you deactivate ESP®.
- you shift the transmission to **P**, **R** or **N**.

If DISTRONIC is deactivated, you will hear a warning tone. You will see the **DISTRONIC Off** message in the multifunction display for approximately five seconds.

Tips for driving with DISTRONIC

The following contains descriptions of certain road and traffic conditions in which you must be particularly attentive. In such situations, brake if necessary. DISTRONIC is then deactivated.

WARNING

The DISTRONIC works to maintain the speed selected by the driver unless a moving obstacle proceeding directly ahead of it in the same travel direction is detected (e.g. following another vehicle ahead of you at your set distance).

This means that:

- Your vehicle can pass another vehicle after you have changed lanes.
- While in a sharp turn or if the preceding vehicle is in a sharp turn, the DISTRONIC could lose sight of the preceding vehicle. Your vehicle could then accelerate to the previously selected speed.

The DISTRONIC regulates only the distance between your vehicle and those directly ahead of it, but does not register stationary objects in the road, e.g.:

- a stopped vehicle in a traffic jam
- a disabled vehicle
- an oncoming vehicle

The driver must always be alert, observe all traffic and intercede as required by means of steering or braking the vehicle.

WARNING

The DISTRONIC should not be used in snowy or icy road conditions.

Cornering, going into and coming out of a bend

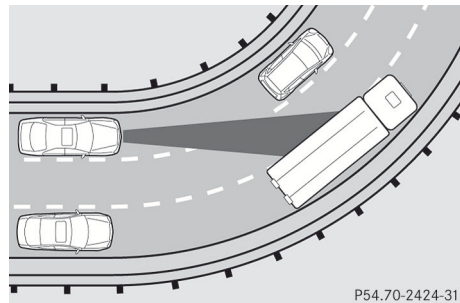

P54.70-2424-31

The ability of DISTRONIC to detect vehicles when cornering is limited. Your vehicle may brake unexpectedly or late.

Vehicles traveling on a different line

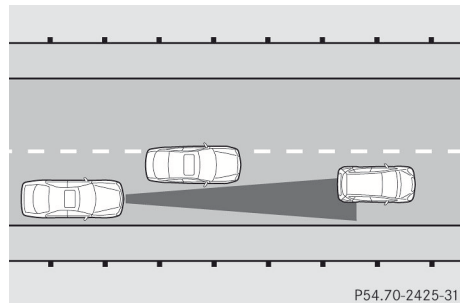

P54.70-2425-31

DISTRONIC may not detect vehicles traveling on a different line. The distance to the vehicle in front will be too short.

Other vehicles changing lane

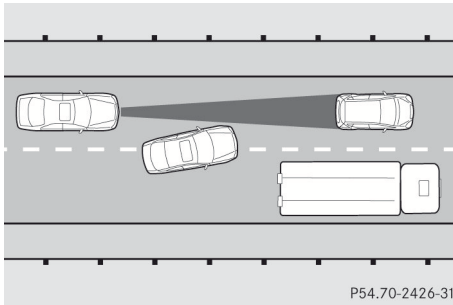

DISTRONIC has not detected the vehicle cutting in yet. The distance to this vehicle will be too short.

Narrow vehicles

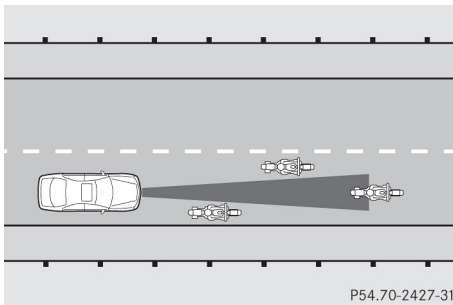

DISTRONIC has not yet detected the vehicle in front on the edge of the road, because of its narrow width. The distance to the vehicle in front will be too short.

Obstructions and stationary vehicles

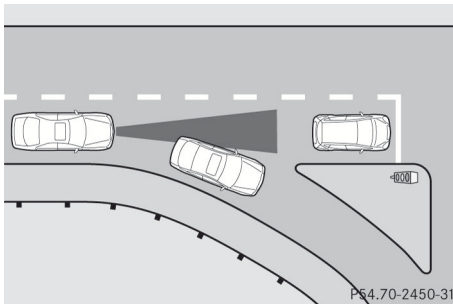

DISTRONIC does not brake for obstructions or stationary vehicles. If, for example, the

detected vehicle turns a corner and reveals an obstacle or stationary vehicle, DISTRONIC will not brake for these.

Crossing vehicles

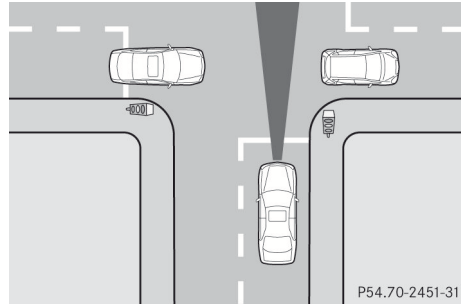

DISTRONIC may detect vehicles that are crossing your lane by mistake. Activating DISTRONIC at, for example, a traffic light with crossing traffic, could cause your vehicle to pull away at the wrong time.

Rear axle level control

The rear axle level control regulates the vehicle level at the rear axle. The benefit of this is that the vehicle level at the rear axle is kept constant regardless of the load.

Observe the notes on driving with a trailer (▷ page 191).

AIRMATIC package

General notes

AIRMATIC enables a suspension tuning setting to be selected and regulates the damping behavior and level of your vehicle. The system comprises two components: ADS (Adaptive Damping System) (▷ page 181) and level control (▷ page 181) .

Observe the notes on driving with a trailer (▷ page 191).

ADS (Adaptive Damping System)

ADS is continuously electronically-controlled. It adapts the damping characteristics to suit the current operating conditions. The damping is controlled for each wheel individually. This improves driving safety and tire comfort.

This depends on:

- your driving style
- the road surface conditions
- the ADS setting
- the vehicle level setting

Your selection remains stored even if you remove the SmartKey from the ignition lock.

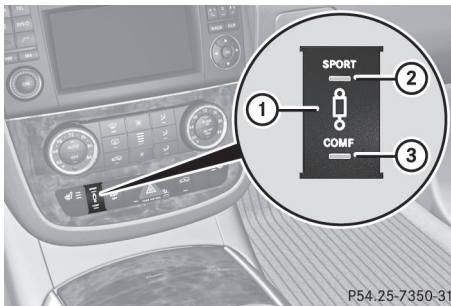

You can choose between the following ADS settings:

- **AUTO** for normal driving situations; indicator lamps ② and ③ are off.
 - **SPORT** for sporty driving; indicator lamp ② is on.
 - **COMF** for a more comfortable ride; indicator lamp ③ is on.
- ▶ Start the engine.
- ▶ Press button ① repeatedly until the desired setting is selected.

Level control

Level control adapts the vehicle level automatically to the current operating and driving situation. This results in reduced fuel consumption and improved handling.

Make changes to the vehicle level while the vehicle is in motion. This enables the vehicle to adjust to the new level as quickly as possible.

The vehicle level may change visibly when you park the vehicle and the outside temperature changes. When the temperature drops, the vehicle level is lower; with an increase in temperature, the vehicle level rises.

When you unlock the vehicle or open a door, the vehicle begins to balance the load discrepancies while still parked. However, for significant level changes, e.g. after the vehicle has been stationary for a long period, the engine must be on. For safety reasons, the vehicle is only lowered when the doors are closed. Lowering is interrupted if a door is opened and continues once the door has been closed.

WARNING

Make sure no one is near the wheel housing or under the vehicle when you lower the vehicle while it is standing still. Limbs could become wedged into or under the vehicle.

For safety reasons, the vehicle can only be lowered with all doors and the tailgate closed. Lowering is interrupted if a door or the tailgate is opened and will continue after the door is closed again.

- ❗ When driving in very poor road conditions, select a high vehicle level in good time. Make sure that there is always sufficient ground clearance to prevent damage to the vehicle.
- ❗ Remove the key from the ignition lock before raising the vehicle completely, e.g. with a vehicle lift.

Basic settings

Select raised level for very poor road conditions (> page 182) or highway level for normal road conditions (> page 182).

The vehicle is automatically lowered to high-speed level when you:

- drive faster than 70 mph (112 km/h)
- drive between 60 mph (96 km/h) and 70 mph (112 km/h) for approximately 20 seconds.

The individual vehicle levels differ from highway level as follows:

- +1.97 in (+ 50 mm) at the raised level
- +/-0 in (+/-0 mm) at the highway level
- -0.47 in (-12 mm) at the high-speed level

- i** The high-speed level is not available if you are pulling a trailer. Observe the notes on driving with a trailer (▷ page 191).
- i** Observe the speed limitations. Drive carefully at an appropriate speed.

Raised level

Only select raised level when this is appropriate for the road conditions. Otherwise, fuel consumption may increase and handling may be affected.

If you select the raised level at a speed of over 40 mph (64 km/h) the **Level Selection Not Permitted** message appears in the multifunction display.



- ▶ Start the engine.

Indicator lamp ② is not lit:

- ▶ Press button ①.
- Indicator lamp ② flashes. The vehicle rises to raised level.

While the adjustment is taking place, a message appears in the multifunction display, e.g.:



If you press the , , or button on the multifunction steering wheel, the message will disappear.

Once the vehicle has reached raised level, indicator lamp ② remains lit. A message appears in the multifunction display for approximately five seconds, e.g.:

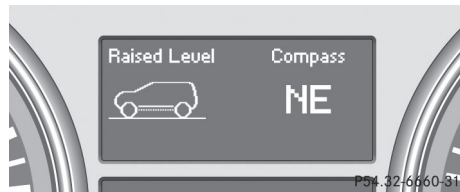

The level is automatically taken up to highway level if you drive faster than 25 mph (40 km/h).

Highway level

- !** Make sure that there is enough ground clearance when the vehicle is being lowered. It could otherwise hit the ground, damaging the underbody.







- ▶ Make sure that the doors are closed.
- ▶ Start the engine.

If indicator lamp ② is lit:

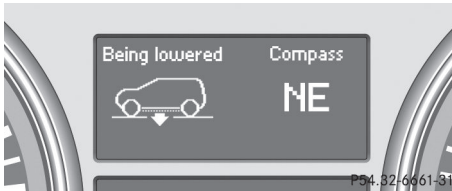
- ▶ Press button ①.
Indicator lamp ② flashes. The vehicle is lowered to highway level.

While the adjustment is taking place, a message appears in the multifunction display, e.g.:



If you press the , ,  or  button on the multifunction steering wheel, the message will disappear.

Once highway level has been reached, indicator lamp ② goes out. A message appears in the multifunction display for approximately five seconds, e.g.:

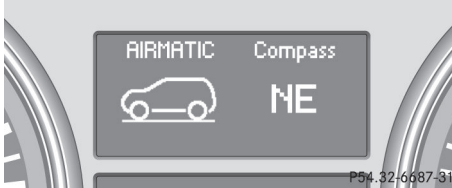

The level is automatically raised from high-speed level to highway level if the speed falls below 40 mph (64 km/h). The level is automatically taken up to highway level if you drive faster than 25 mph (40 km/h).

4MATIC (permanent four-wheel drive)

4MATIC ensures that all four wheels are permanently driven. Together with ESP® and 4ETS, it improves the traction of your vehicle whenever a drive wheel spins due to insufficient grip.

WARNING

If a drive wheel is spinning due to insufficient traction:

- While driving off, apply as little throttle as possible.
- While driving, ease up on the accelerator pedal.
- Adapt your speed and driving style to the prevailing road conditions.

Failure to observe these guidelines could cause the vehicle to skid.

The 4MATIC cannot prevent accidents resulting from excessive speed.

- ❗ Never tow the vehicle with one axle raised. This may damage the transfer case. Damage of this sort is not covered by the Mercedes-Benz Limited Warranty. All wheels must remain either on the ground or be fully raised. Observe the instructions for towing the vehicle with all wheels in full contact with the ground.

i In wintry driving conditions, the maximum effect of 4MATIC can only be achieved if you use winter tires (M+S tires), with snow chains if necessary.

- ❗ When testing the parking brake, operate the vehicle only briefly (for a maximum of ten seconds) on a brake test dynamometer. When doing this, turn the key to position **0** or **1** in the ignition. Failure to do this can cause damage to the drive train or the brake system.

- ❗ Function or performance tests may only be performed on a 2-axle dynamometer. If you wish to operate the vehicle on such a dynamometer, please consult an authorized Mercedes-Benz Center beforehand. You could otherwise damage the drive train or the brake system.

PARKTRONIC

Important safety notes

WARNING

The PARKTRONIC is a supplemental system. It is not intended to, nor does it replace, the need for extreme care. The responsibility during parking and other critical maneuvers always remains with the driver.

WARNING

Make sure no persons or animals are in or near the area in which you are parking/ maneuvering. Otherwise, they could be injured.

PARKTRONIC is an electronic parking aid with ultrasonic sensors. It indicates visually and audibly the distance between your vehicle and an object.

PARKTRONIC is activated automatically when you:

- switch on the ignition
- shift the transmission to position **D**, **R** or **N**
- release the parking brake

PARKTRONIC is deactivated at speeds above 11 mph (18 km/h). It is reactivated at lower speeds.

PARKTRONIC monitors the area around your vehicle using six sensors in the front bumper and four sensors in the rear bumper.

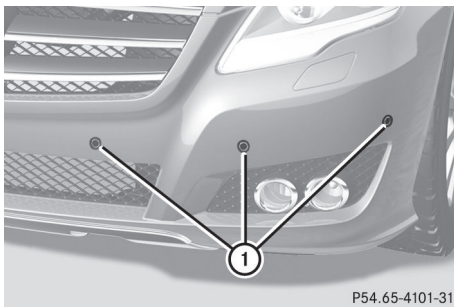

- ① Sensors in the front bumper, left-hand side (example)

Range of the sensors

General notes

The sensors must be free of dirt, ice and slush; otherwise they may not function correctly. Clean the sensors regularly, taking care not to scratch or damage them (> page 291).

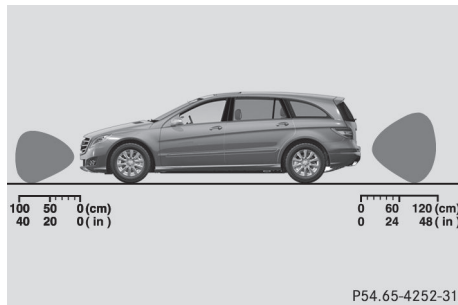

Side view

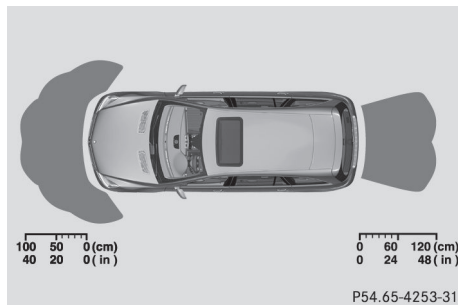

Top view

Front sensors

Center	Approximately 40 in (approximately 100 cm)
Corners	Approximately 24 in (approximately 60 cm)

Rear sensors

Center	Approximately 48 in (approximately 120 cm)
Corners	Approximately 32 in (approximately 80 cm)

! When parking, pay particular attention to objects above or below the sensors, such as flower pots or trailer drawbars. PARKTRONIC does not detect such objects when they are in the immediate vicinity of the vehicle. You could damage the vehicle or the objects.

The sensors may not detect snow and other objects that absorb ultrasonic waves.

Ultrasonic sources such as an automatic car wash, the compressed-air brakes on a truck or a pneumatic drill could cause PARKTRONIC to malfunction.

PARKTRONIC may not function correctly on uneven terrain.

Minimum distance

Center	Approximately 8 in (approximately 20 cm)
Corners	Approximately 6 in (approximately 15 cm)

If there is an obstacle within this range, the relevant warning displays light up and a warning tone sounds. If the distance falls below the minimum, the distance may no longer be shown.

Warning displays

The warning displays show the distance between the sensors and the obstacle. The warning display for the front area is located on the dashboard above the center air vents. The warning display for the rear area is in the roof lamp in the rear compartment.

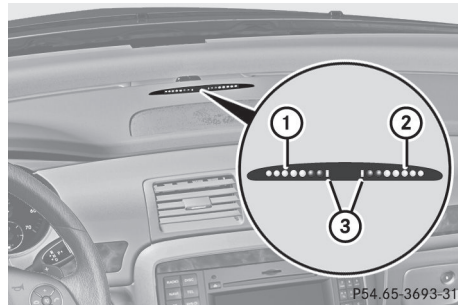

Warning display for the front area

- ① Segments on the left-hand side of the vehicle
- ② Segments on the right-hand side of the vehicle
- ③ Segments showing operational readiness

The warning display for each side of the vehicle is divided into five yellow and two red segments. PARKTRONIC is operational if yellow segments showing operational readiness ③ light up.

The selected transmission position determines which warning display is active when the engine is running.

Transmission position	Warning display
D	Front area activated
R or N	Rear and front areas activated
P	No areas activated

One or more segments light up as the vehicle approaches an obstacle, depending on the vehicle's distance from the obstacle.

From the:

- sixth segment onwards, you will hear an intermittent warning tone for approximately two seconds.
- seventh segment onwards, you will hear a warning tone for approximately two seconds. This indicates that you have now reached the minimum distance.

Deactivating/activating PARKTRONIC

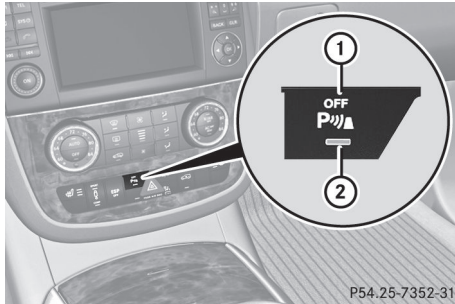

- ① To deactivate/activate PARKTRONIC
- ② Indicator lamp

If indicator lamp ② lights up, PARKTRONIC is deactivated.

- i** PARKTRONIC is automatically activated when you turn the SmartKey to position **2** in the ignition lock.

Trailer towing

PARKTRONIC is deactivated for the rear area when you establish an electrical connection between your vehicle and a trailer.

- !** Remove the detachable ball coupling if the trailer tow hitch is not required. PARKTRONIC measures the minimum detection range to an obstacle from the bumper, not the ball coupling.

Problems with PARKTRONIC

Problem	Possible causes/consequences and ► Solutions
Only the red segments in the PARKTRONIC warning displays are lit. You also hear a warning tone for approximately two seconds. PARKTRONIC is deactivated after approximately 20 seconds, and the indicator lamp in the PARKTRONIC button lights up.	<p>PARKTRONIC has malfunctioned and has switched off.</p> <ul style="list-style-type: none"> ► If problems persist, have PARKTRONIC checked at a qualified specialist workshop.
Only the red segments in the PARKTRONIC warning displays are lit. PARKTRONIC is deactivated after approximately 20 seconds.	<p>The PARKTRONIC sensors are dirty or there is interference.</p> <ul style="list-style-type: none"> ► Clean the PARKTRONIC sensors (▷ page 291). ► Switch the ignition back on. <p>The problem may be caused by an external source of radio or ultrasound waves.</p> <ul style="list-style-type: none"> ► See if PARKTRONIC functions in a different location.

Rear view camera

Important safety notes

The rear view camera is an optical parking aid. It shows the area behind your vehicle in the COMAND display.

WARNING

Make sure that no persons or animals are in the maneuvering range. Otherwise, they could be injured.

The rear view camera is located in the handle strip of the tailgate.

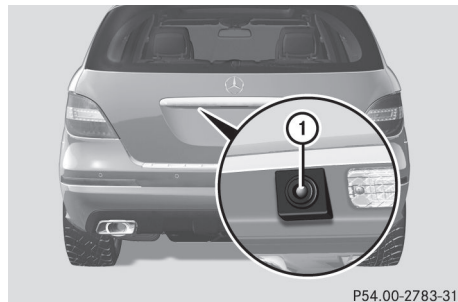

① Rear view camera

View through the camera

The area behind the vehicle is displayed as a mirror image, as in the rear-view mirror.

⚠ WARNING

The rear view camera is only an aid and may display obstacles

- from a distorted perspective
- inaccurately
- may not display obstacles at all

The rear view camera does not relieve you of the responsibility to be cautious. Take care and pay careful attention. The rear view camera may not show objects which are

- very close to the rear bumper
- under the rear bumper
- above the tailgate handle

You are responsible for safety at all times and must continue to pay attention to the immediate surroundings when parking and maneuvering. This includes the area behind, in front of, and beside the vehicle. Otherwise you could endanger yourself and/or others.

⚠ WARNING

The rear view camera will not function or will not fully function if:

- the tailgate is open
- it is raining or snowing strongly or if it is foggy
- it is night or if you are parking/ maneuvering your vehicle in a very dark area
- a very bright white light is affecting the camera
- the immediate vicinity is illuminated with fluorescent light (the display can flicker)
- temperature changes abruptly, for example if you drive out of the cold into a heated garage (condensation on the lens)
- the camera lens is dirty or covered
- the rear of your vehicle is damaged

In this case, have the position and the setting of the camera checked at a specialist workshop. Mercedes-Benz recommends that you consult a Mercedes-Benz Center for this purpose.

Do not use the rear view camera in these situations. You could otherwise injure yourself and other people and/or cause damage - including damage to your vehicle - while parking/maneuvering.

Activating the rear view camera

- ▶ Make sure that the SmartKey is in position **2** in the ignition lock.
- ▶ Make sure that the "rear view camera" function is selected in COMAND (see the separate operating instructions for COMAND).
- ▶ Engage reverse gear.
The area behind the vehicle is shown in the COMAND display with guide lines.

Guide lines in the COMAND display**⚠ WARNING**

Use of rear view camera can be dangerous if you are color-blind or have impaired color vision.

Only use rear view camera if you can see and distinguish all colored guidelines shown by rear view camera on the COMAND system display.

⚠ WARNING

Please note that objects that do not touch the ground may appear to be further away than they actually are, for example:

- the bumper of a vehicle parked behind you
- the trailer drawbar
- the ball coupling of a trailer tow hitch
- the rear end of a truck
- a slanted post

In such cases, you should not use the guide lines to judge the distance. You may misjudge the distance, which increases the risk of impacting the objects.

Even if the object you approach is directly on the ground, do not approach the object any closer than the red guide line.

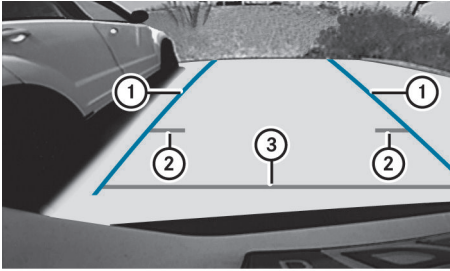

P54.65-4407-31

Information in the COMAND display (example)

Guide lines ② and ③ show the approximate distance to the rear area. Yellow guide line ② indicates a distance of approximately 3 ft (1 m) and red guide line ③ indicates a distance of approximately 10 in (0.25 m). The distances only apply to objects that are at ground level. Blue guide lines ① depict the width required for the vehicle. They are used to align the vehicle with the edge of the road, e.g. the curb.

Blind Spot Assist

Important safety notes

Blind Spot Assist uses a radar sensor system to monitor the areas on both sides of your vehicle. It begins to work at speeds of approximately 20 mph (30 km/h). A warning display in the exterior mirrors draws your attention to detected vehicles in the monitored area. If you then indicate a turn towards that side before changing lanes, you will also receive visual and audible collision warnings. The Blind Spot Assist monitoring system uses sensors in the rear bumper.

WARNING

Blind Spot Assist is only an aid designed to assist driving. It may fail to detect some vehicles and is no substitute for attentive driving.

Blind Spot Assist cannot detect road and traffic conditions. It may fail to detect narrow

vehicles, such as motorcycles or bicycles, or may only detect them too late.

Monitoring may be affected by dirty sensors, strong spray or poor visibility caused by snow, rain or mist, for example. In this case, vehicles are detected late or not at all.

Always pay attention to traffic conditions and your surroundings. Otherwise, you may fail to recognize dangers in time, cause an accident and injure yourself and others.

USA only:

This device has been approved by the FCC as a “Vehicular Radar System”. The radar sensor is intended for use in an automotive radar system only. Removal, tampering, or altering of the device will void any warranties, and is not permitted by the FCC. Do not tamper with, alter, or use in any non-approved way.

Any unauthorized modification to this device could void the user’s authority to operate the equipment.

For Blind Spot Assist to assist you when driving, the radar sensor system must be activated (> page 208) and operational.

Monitoring range of the sensors

Blind Spot Assist monitors the area shown in the figure up to 10 ft (3 m) behind and immediately adjacent to your vehicle.

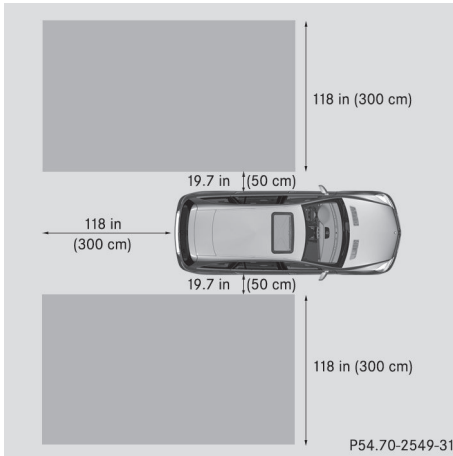

WARNING

Blind Spot Assist monitors certain areas in the immediate vicinity of your vehicle. Vehicles that approach and drive past at high speeds are not detected. There is no display and no warning.

If the lanes are very wide, it may not be possible to monitor the complete width of the neighboring lane. For this reason, vehicles in the next lane may not be detected, especially if they are driving in a staggered formation. This may be the case if vehicles are driving at that edge of their lane which is furthest away from your vehicle.

Always pay attention to traffic conditions and your surroundings. Otherwise, you may fail to recognize dangers in time, cause an accident and injure yourself and others.

If the lanes are narrow, vehicles driving in the lane beyond the lane next to your vehicle may be indicated, especially if the vehicles are not driving in the middle of their lane. This may be the case if the vehicles are driving on the inner side of their lane.

Due to the nature of the system:

- warnings may be issued in error when driving close to crash barriers or similar solid lane borders.
- warnings may be interrupted when driving alongside particularly long vehicles, for example trucks, for a prolonged time.

The two sensors for Blind Spot Assist are integrated into the sides of the rear bumper. Make sure that the bumper is free from dirt, ice or slush around the sensors. The radar sensors must not be covered, for example by bicycle racks or overhanging cargo. Following a severe impact or in the event of damage to the bumpers, have the function of the radar sensors checked at a qualified specialist workshop, such as an authorized Mercedes-Benz Center. Blind Spot Assist may otherwise not work properly.

Indicator and warning display

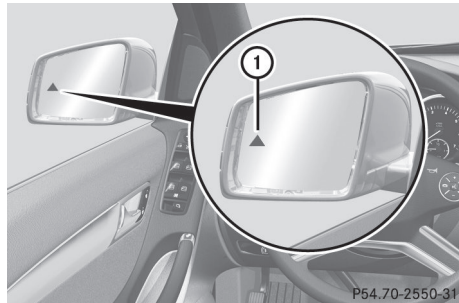

① Yellow indicator lamp/red warning lamp

When Blind Spot Assist is activated, indicator lamp ① lights up yellow in the exterior mirrors up to a vehicle speed of 20 mph (30 km/h). When the vehicle speed exceeds 20 mph (30 km/h), the indicator lamp goes out and Blind Spot Assist is ready for use.

When your speed exceeds approximately 20 mph (30 km/h), warning lamp ① lights up red on the corresponding side whenever a vehicle is detected in the blind spot monitoring range. This warning is always given when a vehicle enters the blind spot monitoring range from behind or from the

side. When you are passing another vehicle, the warning is emitted only if the difference in speed is less than 7 mph (12 km/h).

The yellow indicator lamp goes out if the reverse gear is engaged. In this event, Blind Spot Assist is no longer active.



The brightness of the indicator/warning lamps is adjusted automatically according to the ambient light.

WARNING

Blind Spot Assist is not active at speeds under approximately 20 mph (30 km/h). The indicator lamps in the exterior mirrors are yellow. Vehicles in the monitoring range are then not indicated.

Always pay attention to traffic conditions and your surroundings. Otherwise, you may fail to recognize dangers in time, cause an accident and injure yourself and others.

Collision warning

If a vehicle is detected in the monitoring range of Blind Spot Assist and you switch on the turn signal, a double warning tone sounds. Red warning lamp  flashes. If the turn signal remains on, detected vehicles are indicated by the flashing of red warning lamp . There are no further warning tones.

Switching on Blind Spot Assist

- ▶ Make sure that the radar sensor system (> page 208) and Blind Spot Assist (> page 210) are activated in the on-board computer.
- ▶ Turn the SmartKey to position **2** in the ignition lock.
Warning lamps  light up red in the exterior mirrors for approximately 1.5 seconds and then turn yellow.

Trailer towing

When you attach a trailer, make sure you have correctly established the electrical connection. This can be accomplished by

checking the trailer lighting. In this event, Blind Spot Assist is deactivated. The indicator lamp in the exterior mirrors lights up yellow and the **Blind Spot Assist Currently Unavailable** See Operator's Manual message appears in the multifunction display.

-  You can deactivate the indicator lamps in the exterior mirrors.

To do so, switch off Blind Spot Assist when:

- the SmartKey is in position **2** in the ignition lock.
- the engine is not running.
- the electrical connection to the trailer has been established.

Trailer towing

Notes on towing a trailer

Important safety notes

WARNING

When towing a trailer, incorrect equipment and driving style could cause you to lose control of the vehicle.

Towing incorrectly or not observing this Operator's Manual could lead to damage to the vehicle and/or serious injuries. Observe the following guidelines to ensure safe trailer towing.

Contact a Mercedes-Benz Center if you need further explanation of the information contained in this Operator's Manual.

General information

- Only install an approved trailer coupling on your vehicle.
Further information on availability and on installation is available from any authorized Mercedes-Benz Center.
- The bumpers of your vehicle are not suitable for installing detachable trailer couplings.

- Do not install hired trailer couplings or other detachable trailer couplings on the bumpers of your vehicle.
- To reduce the risk of damage to the ball coupling, remove it from the ball coupling recess when not in use.

Coupling up a trailer

WARNING

Vehicles with AIRMATIC: While you are coupling or decoupling a trailer, make sure nobody locks or unlocks the vehicle and/or opens or closes doors or the tailgate.

The vehicle's level could change and you could endanger yourself and/or others as a result.

Make sure that you do not operate the ADS switch or the vehicle level control system when coupling/decoupling the trailer.

Observe the maximum permissible trailer dimensions (width and length).

Most federal states and all Canadian provinces require by law:

- safety chains between the towing vehicle and the trailer. The chains should be cross-wound under the trailer drawbar. They must be fastened to the vehicle's trailer coupling, not to the bumper or the axle. Allow for enough play in the chains to facilitate turning tight corners.
- a separate brake system for certain types of trailer.
- a safety switch for braked trailers. Check the specific legal requirements applicable to your federal state.
If the trailer detaches from the towing vehicle, the safety switch applies the trailer's brakes.

! Do not connect the trailer's brake system (if featured) to the hydraulic brake system of the towing vehicle, as the latter is equipped with an anti-lock brake system. Doing so will result in a loss of function of

the brake systems of both the vehicle and the trailer.

- i** The vehicle's wiring harness features a line to the brake indicator lamp.
- ▶ Make sure that the automatic transmission is set to position **P**.
- ▶ Apply the vehicle's parking brake.
- ▶ Start the engine.
- ▶ Vehicles with the AIRMATIC package: select highway level and set ADS to **AUTO** or **COMF**.
- ▶ Switch off the engine.
- ▶ Close all doors and the tailgate.
- ▶ Couple up the trailer.
- ▶ Establish all electrical connections.

i Vehicles with the AIRMATIC package: with a trailer attached, the vehicle will always remain at highway level. When coupling up a trailer, please observe the following:

- if highway level has not been set manually, the vehicle will automatically sink to highway level as soon as it reaches a speed of 5 mph (8 km/h).
- high-speed level is not available.

These restrictions apply to all accessories powered through a connection to the trailer power socket of your vehicle, e.g. a bicycle carrier.

Towing a trailer

There are numerous legal requirements concerning the towing of a trailer, e.g. speed restrictions. Make sure that your vehicle/trailer combination complies with the local requirements not only in your area of residence but also at any location to which you are traveling. The police and local authorities can provide reliable information.

Please observe the following when towing a trailer:

- To acquaint yourself with driving with a trailer and with the resulting changes to handling, you should practice cornering, stopping and reversing in a traffic-free location.
- Before driving, check:
 - the trailer tow hitch
 - the safety switch for braked trailers
 - the safety chains
 - the electrical connections
 - the lights
 - the wheels
- Adjust the exterior mirrors to provide an unobstructed view of the rear section of the trailer.
- If the trailer features electronically controlled brakes, pull away the vehicle/trailer combination carefully, manually brake using the brake controller, and check the brakes for correct function.
- Secure any objects on the trailer to prevent the cargo from slipping when the vehicle is in motion.
- If you couple up a trailer, regularly check the cargo for secure fastening and make sure that the trailer lamps and (if applicable) the trailer brakes are functioning correctly.
- Bear in mind that the handling will be less stable when towing a trailer than when driving without one. Avoid sudden steering movements.
- The vehicle/trailer combination is heavier, accelerates more slowly, has a decreased gradient climbing capability and a longer braking distance.
It is more susceptible to side winds and requires more careful steering.
- If possible, avoid abrupt braking. Depress the brake pedal moderately at first, so that the trailer can activate its own brakes. Then increase the pressure on the brake pedal.

- If the automatic transmission continues to shift back and forth between two gears when driving up or downhill, restrict the shift range. Select shift range **4, 3, 2**, or **1**. A lower gear and lower speed reduce the risk of engine failure.
- When driving downhill, shift to a lower gear to utilize the engine's braking effect. Avoid continuous brake application as this may overheat the vehicle brakes and, if installed, the trailer brakes.
- If the coolant temperature increases dramatically while the air-conditioning system is switched on, switch off the air-conditioning system.
Coolant heat can additionally be dissipated by opening the windows and by setting the blower fan and the interior temperature to maximum.
- When overtaking, pay particular attention to the extended length of your vehicle/trailer combination.
Due to the length of your vehicle/trailer combination, you will have to travel an additional distance beyond the vehicle you are overtaking before returning to the previous lane.

Decoupling a trailer

WARNING

Vehicles with AIRMATIC: While you are coupling or decoupling a trailer, make sure nobody locks or unlocks the vehicle and/or opens or closes doors or the tailgate.

The vehicle's level could change and you could endanger yourself and/or others as a result.

Make sure that you do not operate the ADS switch or the vehicle level control system when coupling/decoupling the trailer.

- ▶ Make sure that the automatic transmission is set to position **P**.
- ▶ Apply the vehicle's parking brake.

- ▶ Start the engine.
- ▶ Close all doors and the tailgate.
- ▶ Apply the trailer's parking brake.

WARNING

Vehicles with AIRMATIC: As soon as you disconnect the electrical connection between the trailer and the vehicle, the vehicle will lower. To help avoid personal injury, make sure no one is near the wheel housing or underneath the vehicle before the electrical connection is disconnected.

When you decouple the trailer, the vehicle is temporarily raised because the springs are relieved of load. Be especially careful during this process, as you could otherwise injure yourself and/or others. Make sure that any persons remaining in the vehicle do not press the switches for vehicle level control or the ADS.

- ▶ Remove the trailer cable and decouple the trailer.
- ▶ Switch off the engine.

Permissible trailer loads and drawbar noseweights

Weight specifications

The Gross Trailer Weight (GTW) is the combined weight of the trailer together with the cargo and equipment loaded on the trailer. Permissible gross weight: 3500 lb (1588 kg).

The permissible Trailer drawbar Weight Rating (TWR) is the maximum weight permitted on the trailer drawbar: 350 lb (158 kg) limit for Mercedes-Benz-approved trailer couplings.

Loading a trailer

- When loading a trailer, please note that neither the permissible gross trailer weight nor the permissible Gross Vehicle Weight Rating (GVWR) may be exceeded. The

permissible Gross Vehicle Weight Rating (GVWR) is specified on the type plate located on the B-pillar on the driver's side of your vehicle.

You can find the maximum permissible values on the type plates of your vehicle and the trailer. Always observe the lowest respective value when determining the maximum weight with which you can load the vehicle and the trailer.

- The drawbar noseweight acting on the ball coupling has to be added to the rear axle weight in order to prevent the permissible Gross Axle Weight Rating (GAWR) from being exceeded. The permissible Gross Vehicle Weight Rating (GVWR) is specified on the type plate located on the B-pillar on the driver's side of your vehicle.

i Mercedes-Benz recommends loading the trailer so that the drawbar noseweight remains between 8% and 10% of the permissible gross trailer weight.

i The weight of additional accessories, passengers, and cargo reduces the permissible trailer load and drawbar noseweight for your vehicle.

Checking the vehicle and trailer weight

- To check that the weights of the towing vehicle and the trailer comply with the maximum permissible values, have the vehicle/trailer combination (including the driver, passengers, and cargo with a fully laden trailer) weighed on a calibrated weighbridge.
- Check the gross axle weight rating of the front and rear axle, the Gross Trailer Weight (GTW), and the drawbar noseweight.

Trailer power supply

The trailer power socket of your vehicle is designed for connecting the 7-pin connector supplied as part of the Mercedes-Benz-approved trailer coupling.

- i** Depending on your trailer, you may need an adapter to connect your trailer to the vehicle.

Further information is available from any authorized Mercedes-Benz Center.

Useful information	198
Important safety notes	198
Displays and operation	198
Menus and submenus	201
Display messages	213
Warning and indicator lamps in the instrument cluster	238

Useful information

- i** This Operator's Manual describes all models and all standard and optional equipment of your vehicle available at the time of publication of the Operator's Manual. Country-specific differences are possible. Please note that your vehicle may not be equipped with all features described. This also applies to safety-related systems and functions.
- i** Please read the information on qualified specialist workshops (▷ page 24).

Important safety notes

You will find an illustration of the instrument cluster in the "At a glance" section (▷ page 29).

WARNING

A driver's attention to the road and traffic conditions must always be his/her primary focus when driving.

For your safety and the safety of others, selecting features through the multifunction steering wheel should only be done by the driver when traffic and road conditions permit it to be done safely.

Bear in mind that at a speed of just 30 mph (approximately 50 km/h), your vehicle is covering a distance of 44 feet (approximately 14 m) every second.

WARNING

No messages will be displayed if either the instrument cluster or the multifunction display is inoperative.

As a result, you will not be able to see information about your driving conditions, such as

- speed
- outside temperature
- warning/indicator lamps

- malfunction/warning messages
- failure of any systems

Driving characteristics may be impaired.

If you must continue to drive, do so with added caution. Contact an authorized Mercedes-Benz Center as soon as possible.

WARNING

Malfunction and warning messages are only indicated for certain systems and are intentionally not very detailed. The malfunction and warning messages are simply a reminder with respect to the operation of certain systems. They do not replace the owner's and/or driver's responsibility to maintain the vehicle's operating safety. Have all required maintenance and safety checks performed on the vehicle. Bring the vehicle to an authorized Mercedes-Benz Center to address the malfunction and warning messages.

Displays and operation

Tachometer

The red band in the tachometer indicates the engine's overrevving range.

- !** Do not drive in the overrevving range, as this could damage the engine.

The fuel supply is interrupted to protect the engine when the red band is reached.

Outside temperature display

The outside temperature display is in the multifunction display (▷ page 200).

WARNING

The outside temperature indicator is not designed to serve as an ice-warning device and is therefore unsuitable for that purpose. Indicated temperatures just above the freezing point do not guarantee that the road

surface is free of ice. The road may still be icy, especially in wooded areas or on bridges.

Changes in the outside temperature are displayed after a short delay.

Speedometer with segments

The segments in the speedometer indicate which speed range is available.

DISTRONIC (▷ page 173) activated:

One or two segments in the set speed range light up.

DISTRONIC detects a vehicle in front:

The segments between the speed of the vehicle in front and the stored speed light up.







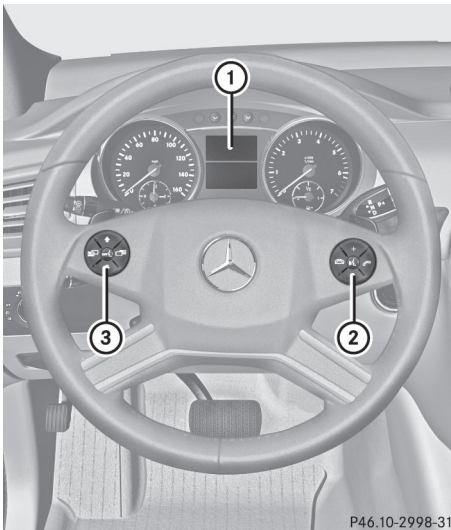

Operating the on-board computer

The on-board computer is activated as soon as you turn the SmartKey to position **1** in the ignition lock.

You can control the multifunction display and the settings in the on-board computer using the buttons on the multifunction steering wheel.



P46.10-2998-31

- ① Multifunction display
 - ②  Rejects or ends a call
Exits phone book/redial memory
 Makes or accepts a call
Switches to the redial memory
 Selects submenus in the **Settings** menu
Changes values
Adjusts the volume
 Switches on the Voice Control System; see the separate operating instructions
 - ③  Selects a menu: scrolls back and forth
 Switches off the Voice Control System; see the separate operating instructions
-  **Press briefly:**
Scrolls back and forth within a menu
In the **Audio** menu: selects a stored station, an audio track or a video scene
In the **Telephone** menu: switches to the phone book and selects a name or a telephone number
-  **Press and hold:**
In the **Audio** menu: selects the previous/next station or selects an audio track using rapid scrolling
In the **Telephone** menu: starts rapid scrolling through the phone book

Multifunction display

Values and settings as well as display messages are shown in the multifunction display.

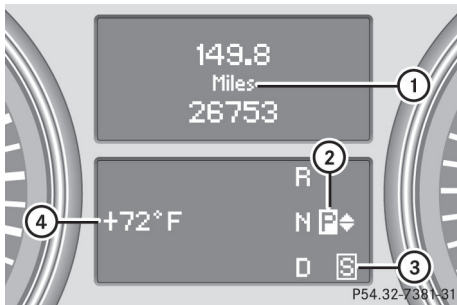

- ① Display area for menus or submenus
- ② Transmission position
- ③ Drive program
- ④ Status bar with outside temperature or speed (▷ page 206)

For further information on displaying the transmission position, see (▷ page 151).

Menus and submenus

Menu overview

The number of menus shown depends on the optional equipment in the vehicle.

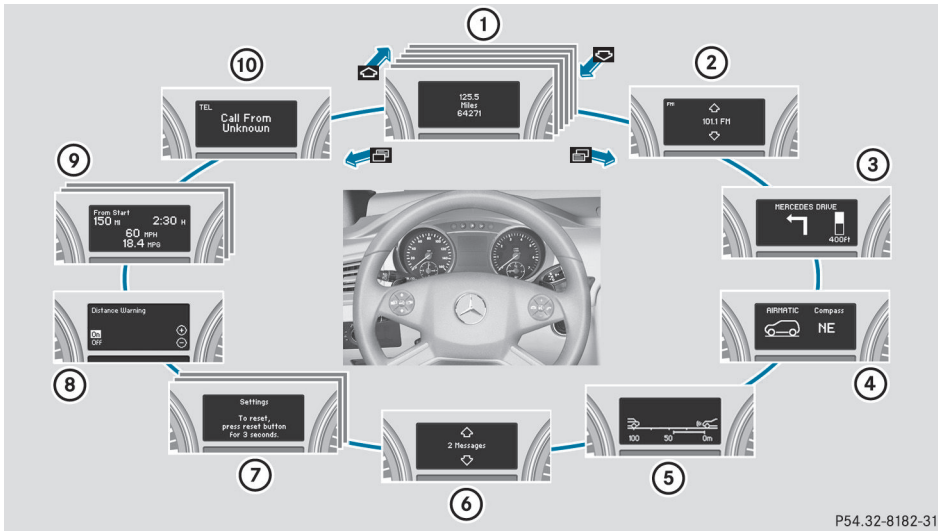

P54.32-8182-31



	Function
①	Standard display menu (▷ page 202) <ul style="list-style-type: none"> • tire pressure loss warning system (Canada only) (▷ page 329) • tire pressure monitor (USA only) (▷ page 331) • ASSYST PLUS service interval display (▷ page 287)
②	Audio menu (▷ page 203)
③	Navigation menu (▷ page 204)
④	AIRMATIC/compass menu (▷ page 204) <ul style="list-style-type: none"> • Level control (▷ page 181) • Compass display (▷ page 278)
⑤	DISTRONIC menu (▷ page 178)
⑥	Message memory ²³ menu (▷ page 213)
⑦	Settings menu (▷ page 205)
⑧	Additional functions menu (▷ page 210)

²³ The menu is only visible if there is a display message.

	Function
⑨	Trip computer menu (▷ page 210)
⑩	Telephone menu (▷ page 211)

Standard display menu

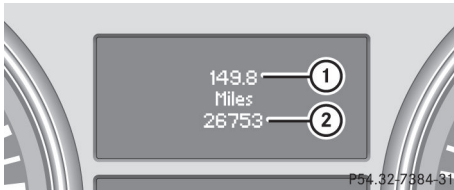

Standard display

- ▶ Press the  or  button on the steering wheel to select the standard display.



Standard display

- ① Trip odometer
- ② Odometer

You can select the following functions in the **Standard display** menu using the  or  button:

- tire pressure loss warning system (▷ page 329) (Canada only)
- tire pressure monitor (▷ page 331) (USA only)
- coolant temperature (▷ page 202)
- digital speedometer or outside temperature (▷ page 202)
- ASSYST PLUS service interval display (▷ page 287)
- ▶ **To reset the trip odometer:** press and hold the  reset button in the instrument cluster until the trip odometer is reset.

Displaying the coolant temperature





WARNING

Driving when your engine is overheated can cause some fluids which may have leaked into

the engine compartment to catch fire. You could be seriously burned.

Steam from an overheated engine can cause serious burns which can occur just by opening the engine hood. Stay away from the engine if you see or hear steam coming from it.

Stop the vehicle in a safe location away from other traffic. Turn off the engine, get out of the vehicle and do not stand near the vehicle until the engine has cooled down.

- ▶ Press the  or  button on the steering wheel to select the standard display.
- ▶ Press the  or  button to select the coolant temperature.

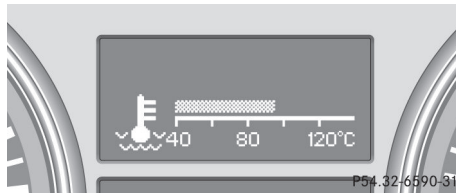





Under normal driving conditions, with the correct anti-corrosion and antifreeze additive concentration, the reading may rise to 248 °F (120 °C).

- ❗ If the coolant temperature exceeds 248 °F (120 °C) do not continue driving. The engine will otherwise be damaged.

Displaying the digital speedometer or outside temperature

If you have selected the digital speedometer for the status bar (▷ page 206), the outside temperature is displayed here.

- ▶ Press the  or  button on the steering wheel to select the standard display.
- ▶ Press the  or  button to select digital speedometer or the outside temperature.



Digital speedometer



Outside temperature



Audio menu

Selecting a radio station

- ❗ SIRIUS XM satellite radio acts like a normal radio.





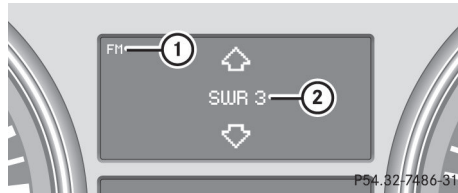

For more information on satellite radio operation, see the separate operating instructions.

You can only change the waveband and store new stations using COMAND.

- ▶ Switch on COMAND and select Radio (see the separate operating instructions).
- ▶ Press the  or  button on the steering wheel to select the **Audio** menu.





- ① Waveband²⁴
- ② Current station

- ▶ **To select a stored station:** briefly press the  or  button.
- ▶ **To select a station from the station list:** press and briefly hold the  or  button.
- ▶ **To select a station using station search²⁵:** press and briefly hold the  or  button.

Operating audio player or audio media

Audio data from various audio devices or media can be played, depending on the equipment installed in the vehicle.

- ▶ Switch on COMAND and select the audio device or medium (see the separate operating instructions).
- ▶ Press the  or  button on the steering wheel to select the **Audio** menu.







CD changer display (example)

- ① Current CD
- ② Current track



²⁴ If current station ② has been stored, the memory position will also be displayed.

²⁵ Only if no station list is received.

- ▶ **To select the next/previous track:** briefly press the  or  button.
- ▶ **To select a track from the track list (rapid scrolling):** press and briefly hold the  or  button.

The current track will not be displayed in audio AUX mode (**A**uxiliary audio mode: external audio source connected).

Operating video DVD

- ▶ Switch on COMAND and select video DVD (see the separate operating instructions).
- ▶ Press the  or  button on the steering wheel to select the **A**udio menu.

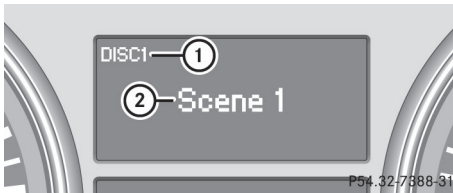

DVD changer display (example)



- ① Current DVD (for DVD changer)
- ② Current scene

- ▶ Press the  or  button to select a scene.

Navigation system menu

Displaying navigation instructions

In the **N**avigation menu: the instructions from the navigation system appear in the multifunction display. For more information, see the separate operating instructions.

- ▶ Switch on COMAND (see the separate operating instructions).
- ▶ Press the  or  button on the steering wheel to select the **N**avigation menu.

Route guidance inactive

The direction of travel appears in the multifunction display. If the name of the street is part of the navigation system data, this will also be displayed.



Route guidance active

The multifunction display shows navigation instructions, for example:

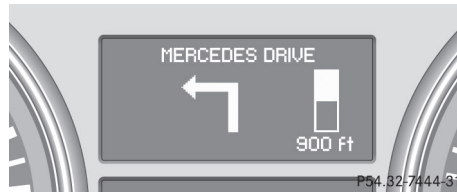

AIRMATIC/compass menu

In the **A**IRMATIC/**C**ompass menu you can view the messages for level control (▷ page 181) and see the compass display (▷ page 278). The display in the **A**IRMATIC/**C**ompass menu depends on the optional equipment in your vehicle.

- ▶ Press  or  on the steering wheel to select the **A**IRMATIC/**C**ompass menu.



Example display for vehicles with AIRMATIC package and compass

Settings menu

Introduction

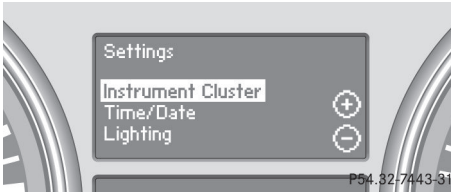



The **Settings** menu can be used for:



- restoring the factory settings
- changing the instrument cluster settings
- changing the time/date settings²⁶
- changing the light settings
- changing the vehicle settings
- changing the convenience settings

Resetting to factory settings

For safety reasons, the **Daytime Running Lamps** function in the **Lighting** submenu is only reset when the engine is switched off.

- ▶ Press  or  on the steering wheel to select the **Settings** menu.
- ▶ Press and hold the **(R)** reset button on the instrument cluster for approximately three seconds.
A prompt appears in the multifunction display asking you to confirm by pressing the **(R)** reset button again.
- ▶ Press the **(R)** reset button again.
The settings of most functions are restored to the factory settings.

or

- ▶ If you want to retain the settings, do not press the **(R)** reset button a second time.
After approximately five seconds, the **Settings** menu reappears.
- ▶ Press the  or  button to select a different menu.











Instrument cluster

Selecting the unit of measurement for distance







This function is only available in Canada.

The **Display unit Speedometer/Odometer** function allows you to choose whether certain displays appear in kilometers or miles.





The selected unit of measurement for distance applies to:

- the analog speedometer
 - the odometer and the trip odometer
 - the trip computer
 - the navigation instruction in the **Navigation** menu
 - DISTRONIC
- ▶ Press the  or  button on the steering wheel to select the **Settings** menu.
 - ▶ Press the  button to call up the selection of submenus.
 - ▶ Press the  or  button to select the **Instrument Cluster** submenu.
 - ▶ Press the  button to select **Display Unit Speedometer/Odometer**.
 - ▶ Press the  or  button to select **km** or **Miles** as the unit of measurement for distance.
 - ▶ Press the  ,  or  button to select a different display.

Selecting the unit of distance for the digital speedometer











- ▶ Press  or  on the steering wheel to select the **Settings** menu.
- ▶ Press the  button to select submenus.
- ▶ Press the  or  button to select the **Instrument cluster** submenu.
- ▶ Press the  button to display **Display unit Digital speedometer**.

²⁶ This function is not available in vehicles with the navigation module.











- ▶ Press the  or  button to select **km** or **miles** as the unit of measurement for distance.
- ▶ Press the ,  or  button to select a different display.

Selecting the language

The **Language**: function allows you to select the language for the instrument cluster.

- ▶ Press  or  on the steering wheel to select the **Settings** menu.
- ▶ Press the  button to select submenus.
- ▶ Press  or  to select the **Instrument cluster** submenu.
- ▶ Press  to select **Language**.
- ▶ Press the  or  button to select the desired language.
- ▶ Press the ,  or  button to select a different display.

Selecting the status line display







- ▶ Press  or  on the steering wheel to select the **Settings** menu.
- ▶ Press the  button to select submenus.
- ▶ Press  or  to select the **Instrument cluster** submenu.
- ▶ Press  to select **Status line display**.
- ▶ Press  or  to select the display in the status line: speed (**Speed**) or outside temperature (**Outside temp.**).
The selected display now appears constantly in the lower multifunction display. When you scroll through the **Standard display** menu (▷ page 202), you will see the display you have not selected.
- ▶ Press the ,  or  button to select a different display.

Time/date







This submenu is only available on vehicles with no navigation module. To set the time and the date for vehicles with a navigation

module, see the separate operating instructions.

In the **Time/date** submenu, you can set the time and date.

- ▶ Press  or  on the steering wheel to select the **Settings...** menu.
- ▶ Press the  button to select submenus.
- ▶ Press the  or  button to select the **Time/date** submenu.
- ▶ **To set the time:** press  to select **Clock Set Hour** or **Clock Set Minute(s)**.

or

- ▶ **To set the date:** press  to select **Date Set Day**, **Date Set Month** or **Date Set Year**.
- ▶ Press  or  to set a value.
- ▶ Press the ,  or  button to select a different display.

Lights

Switching the daytime running lamps on/off



This function is not available in Canada.









If you have activated the **Daytime Running Lights** function and the light switch is in the  or **AUTO** position, the daytime running lamps are automatically switched on when the engine is running.

In the dark, the following also light up:

- the low-beam headlamps
- the parking lamps
- the tail lamps
- the license plate lamp
- the side marker lamps

On vehicles with daytime running lamps, the factory setting is **On**

- ▶ Switch off the engine.
- ▶ Press  or  on the steering wheel to select the **Settings** menu.
- ▶ Press the  button to select submenus.











- ▶ Press the  or  button to select the **Lighting** submenu.
- ▶ Press  to select **Daytime Running Lamps**.
- ▶ Press  or  to set daytime running lamps to **On** or **Off**.
- ▶ Press the ,  or  button to select a different display.

Switching the surround lighting on or off

If you activate the surround lighting function and the light switch is set to **AUTO**, the following will light up if it is dark and you unlock the vehicle using the SmartKey:

- the parking lamps
- the license plate lamp
- the tail lamps
- the fog lamps²⁷
- the low-beam headlamps²⁸
- the side marker lamps
- the surround lighting in the exterior mirrors

The surround lighting switches off automatically after 40 seconds or when the driver's door is opened.

- ▶ Press  or  on the steering wheel to select the **Settings** menu.
- ▶ Press the  button to select submenu.
- ▶ Press the  or  button to select the **Lighting** submenu.
- ▶ Press  to select **Surround lighting function**.
- ▶ Press  or  to switch the **Surround lighting function** on or off.
- ▶ When leaving the vehicle, turn the light switch to position **AUTO**.
The surround lighting is activated.
- ▶ Press the ,  or  button to select a different display.

²⁷ Only for vehicles with front fog lamps.

²⁸ Only for vehicles without front fog lamps.

²⁹ Only for vehicles with front fog lamps.

³⁰ Only for vehicles without front fog lamps.











Activating/deactivating the exterior lighting delayed switch-off

If the **Headlamp deactivation** function is activated and the light switch is in the **AUTO** position, the exterior lighting continues to light for 15 seconds after the doors have been closed when it is dark.

If the engine is switched off and then none of the doors are opened, or if an open door is not closed, the exterior lighting goes out after 60 seconds.

If you have activated the delayed switch-off function, the light switch is set to **AUTO** and you switch off the engine, the following remain lit:

- the parking lamps
- the license plate lamp
- the tail lamps
- the fog lamps²⁹
- the low-beam headlamps³⁰
- the side marker lamp

- ▶ Press  or  on the steering wheel to select the **Settings** menu.
- ▶ Press the  button to select submenu.
- ▶ Press the  or  button to select the **Lighting** submenu.
- ▶ Press the  button to select **Headlamp delayed shut-off**.
- ▶ Press the  or  button to activate or deactivate the **Headlamp delayed shut-off** function.
- ▶ Before switching off the engine, turn the light switch to position **AUTO**.
The exterior lighting delayed switch-off is activated.
- ▶ Press the ,  or  button to select a different display.











Deactivating the delayed switch-off temporarily:

- ▶ Before leaving the vehicle, turn the SmartKey to position **0** in the ignition lock.
- ▶ Turn the SmartKey to position **2** in the ignition lock and back to position **0**. The delayed switch-off is deactivated.

Delayed switch-off is reactivated the next time you start the engine.

Activating/deactivating the interior lighting delayed switch-off







If the **Interior lighting Delayed Shut-off** function is activated and you remove the SmartKey from the ignition lock, the interior lighting remains on for 10 seconds.







- ▶ Press the  or  button on the steering wheel to select the **Settings** menu.
- ▶ Press the  button to select submenu.
- ▶ Press the  or  button to select the **Lighting** submenu.
- ▶ Press the  button to select **Interior Lighting Delayed Shut-off**.
- ▶ Press the  or  button to activate or deactivate the **Interior Lighting Delay** function.
- ▶ Press the ,  or  button to select a different display.

Vehicle

Activating/deactivating the automatic door locking feature











If you select the **Automatic Door Locking** function, the vehicle is centrally locked above a speed of around 9 mph (15 km/h).

- ▶  For further information on the automatic locking feature, see (> page 80).
- ▶ Press the  or  button on the steering wheel to select the **Settings** menu.
- ▶ Press the  button to call up the selection of submenus.
- ▶ Press the  or  button to select the **Vehicle** submenu.

- ▶ Press the  button to select **Automatic Door Locking**.
- ▶ Press the  or  button to switch **Automatic Door Locking** on or off.
- ▶ Press the ,  or  button to select a different display.

Activating/deactivating the acoustic locking confirmation

If you activate the **Acoustic Lock Feedback** function, an audible signal sounds when the vehicle is locked or unlocked. When unlocking, the signal sounds once. When locking, it sounds three times.

- ▶ Press the  or  button on the steering wheel to select the **Settings** menu.
- ▶ Press the  button to call up the selection of submenus.
- ▶ Press the  or  button to select the **Vehicle** submenu.
- ▶ Press the  button to select **Acoustic Lock Feedback**.
- ▶ Press the  or  button to switch the **Acoustic Lock Feedback** function on or off.
- ▶ Press the ,  or  button to select a different display.

Activating/deactivating the radar sensor system

If the radar sensor system is switched off, Blind Spot Assist (> page 189) is deactivated.











- ▶  **USA only:** This device has been approved by the FCC as a "Vehicular Radar System". The radar sensor is intended for use in an automotive radar system only. Removal, tampering, or altering of the device will void any warranties, and is not permitted by the FCC. Do not tamper with, alter, or use in any nonapproved way. Any unauthorized modification to this device could void the user's authority to operate the equipment.

i Canada only:

This device complies with RSS-210 of Industry Canada. Operation is subject to the following two conditions:

1. This device may not cause harmful interference, and
2. this device must accept any interference received, including interference that may cause undesired operation.

Any unauthorized modification to this device could void the user's authority to operate the equipment.

- ▶ Press the  or  button on the steering wheel to select the **Settings** menu.
- ▶ Press the  button to select submenus.
- ▶ Press the  or  button to select the **Vehicle** submenu.
- ▶ Press the  button to select **Radar Sensor (See Operator's Manual)**.
- ▶ Press the  or  button to activate or deactivate the **Radar Sensor (see Operator's Manual)**.
- ▶ Press the ,  or  button to select a different display.

Convenience**Activating/deactivating the EASY-ENTRY/EXIT feature**

You can use the **Easy-entry Function** to activate or deactivate the EASY-ENTRY/EXIT feature (▷ page 108).











⚠ WARNING

You must make sure no one can become trapped or injured by the moving steering wheel when the easy-entry/exit feature is activated.

To stop steering wheel movement do one of the following:











- Move steering wheel adjustment stalk.
- Press one of the memory position buttons.
- Press memory button **M**.

Do not leave children unattended in the vehicle, or with access to an unlocked vehicle. Children could open the driver's door and unintentionally activate the easy-entry/exit feature, which could result in an accident and/or serious personal injury.

- ▶ Press the  or  button on the steering wheel to select the **Settings** menu.
- ▶ Press the  button to select submenus.
- ▶ Press the  or  button to select the **Comfort** submenu.
- ▶ Press the  button to select **Easy-entry Function**.
- ▶ Press the  or  button to activate or deactivate the **Easy-entry Function**.
- ▶ Press the ,  or  button to select a different display.

Switching the belt adjustment on/off











For further information on belt adjustment (▷ page 54).

- ▶ Press the  or  button on the steering wheel to select the **Settings** menu.
- ▶ Press the  button to select submenus.
- ▶ Press the  or  button to select the **Comfort** submenu.
- ▶ Press the  button to select **Belt Adjustment**.
- ▶ Press the  or  button to activate or deactivate **Belt Adjustment**.
- ▶ Press the ,  or  button to select a different display.

Switching the Fold in mirrors when locking function on/off

If you activate the **Fold In Mirrors When Locking** function, the exterior mirrors are folded in when the vehicle is locked. If you switch on the ignition, the exterior mirrors fold out again.







If you have switched the function on and you fold the exterior mirrors in using the button on the door (▷ page 110), they will not fold out automatically. The exterior mirrors can then only be folded out using the button on the door.

- ▶ Press  or  on the steering wheel to select the **Settings** menu.
- ▶ Press the  button to select submenus.
- ▶ Press the  or  button to select the **Convenience** submenu.
- ▶ Press  to select **Fold In Mirrors When Locking**.
- ▶ Press  or  to activate/deactivate the **Fold Mirrors In When Locking** function.
- ▶ Press the ,  or  button to select a different display.

Additional functions menu

Activating/deactivating the distance warning function

This function is only available with DISTRONIC.









- ▶ Press  or  on the steering wheel to select the **Additional functions** menu.
- ▶ Press the  or  button to select the **Distance warning** function.
- ▶ Press the  or  button to activate or deactivate the **Distance warning** system.

When the distance warning function (▷ page 68) is activated, the  symbol is shown in the lower multifunction display.

- ▶ Press the ,  or  button to select a different display.

Activating/deactivating Blind Spot Assist





Further information about Blind Spot Assist (▷ page 189).

- ▶ Press  or  on the steering wheel to select the **Additional functions** menu.
- ▶ Press the  or  button to select the **Blind Spot Assist** function.
- ▶ Press the  or  button to switch **Blind Spot Assist** on or off.
- ▶ Press the ,  or  button to select a different display.

Trip computer menu

Trip computer "From start" or "From reset"

The values in the **From Start** submenu refer to the start of your journey, while those in the **From Reset** submenu refer to the last time you reset (▷ page 211) this submenu.

- ▶ Press the  or  button on the steering wheel to select the **trip computer** menu.
- ▶ Press the  or  button to select **From Start** or **From Reset**.

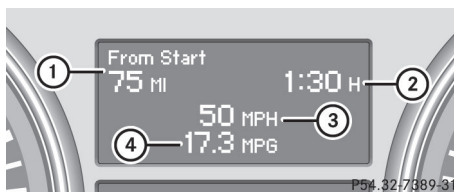

Trip computer "From start" (example)





- ① Distance
- ② Time
- ③ Average speed
- ④ Average fuel consumption

The **From Start** trip computer is reset automatically when:





- the ignition has been switched off for more than four hours.
- 999 hours have been exceeded.
- 9,999 miles have been exceeded.

When 9,999 hours or 99,999 miles have been exceeded, the trip computer is automatically reset [From Reset](#).





Resetting values

- ▶ Press the  or  button on the steering wheel to select the **trip computer** menu.
- ▶ Press the  or  button to select the function that you wish to reset.
- ▶ Press and hold the (R) reset button on the instrument cluster until the values have reverted to "0".

Calling up the range

- ▶ Press  or  on the steering wheel to select the **trip computer** menu.
- ▶ Press  or  to select [Range:](#). The multifunction display shows the estimated range of the vehicle, based on the current driving style and the fuel level. If there is only a small amount of fuel left in the fuel tank, the display shows a vehicle being refueled  instead of the range.

Displaying the current fuel consumption

- ▶ Press  or  on the steering wheel to select the **trip computer** menu.
- ▶ Press  or  to select [Consumption](#). The current fuel consumption is displayed.

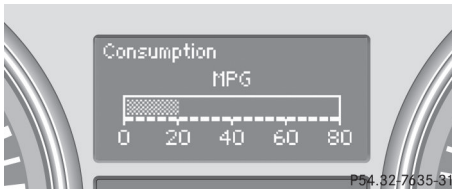

Telephone menu



Introduction

You can establish a Bluetooth® connection to COMAND (see the separate operating instructions).

WARNING

A driver's attention to the road must always be his/her primary focus when driving. For your safety and the safety of others, we recommend that you pull over to a safe location and stop before placing or taking a telephone call. If you choose to use the telephone while driving, please use the hands-free device and only use the telephone when weather, road and traffic conditions permit.

Some jurisdictions prohibit the driver from using a mobile phone while driving a vehicle. Bear in mind that at a speed of just 30 mph (approximately 50 km/h), your vehicle is covering a distance of 44 feet (approximately 14 m) every second.

- ▶ Switch on the mobile phone and COMAND (see the separate operating instructions).
- ▶ Press the  or  button on the steering wheel to select the **Telephone** menu.

You will see one of the following display messages in the multifunction display:

- [Ready](#) or the name of the network provider: the mobile phone has found a network and is ready to receive.
- [No Service](#): no network is available, or the mobile phone is searching for a network.

Accepting a call

If someone calls you when you are in the **Telephone** menu, a display message appears in the multifunction display, for example:

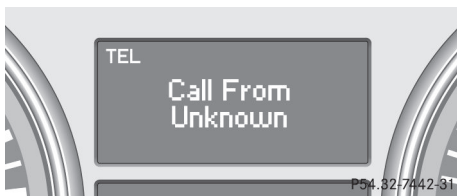

- ▶ Press the  button on the steering wheel to accept an incoming call.

If you are not in the **Telephone** menu, you can still accept a call.





Rejecting or ending a call



- ▶ Press the  button on the steering wheel.



If you are not in the **Telephone** menu, you can still accept a call.

Dialing a number from the phone book

You can enter new telephone numbers into the phone book via the mobile phone (see the separate operating instructions). If your mobile phone is operational, you can select and dial a number from the phone book at any time.









- ▶ Press the  or  button on the steering wheel to select the **Telephone** menu.
- ▶ Press the  or  button to select the desired name.

To start scrolling rapidly, press and hold the  or  button for longer than one second.

- ▶ Press  to start dialing.
- or
- ▶ If you do not want to make a call, press the  button.

Redialing

The on-board computer saves the last names or numbers dialed in the redial memory.

- ▶ Press the  or  button on the steering wheel to select the **Telephone** menu.
 - ▶ Press the  button to switch to the redial memory.
 - ▶ Press the  or  button to select the desired name or number.
 - ▶ Press the  button to start dialing.
- or
- ▶ **If you do not want to make a call:** press the  or  button.

Display messages

General information

WARNING

All categories of messages contain important information which should be taken note of and, where a malfunction is indicated, addressed as soon as possible at an authorized Mercedes-Benz Center.

Failure to repair the condition noted may cause damage not covered by the Mercedes-Benz Limited Warranty, or result in property damage or personal injury.

Display messages appear in the multifunction display.





Display messages with graphic displays may be shown in simplified form in the Operator's Manual and may differ from the messages shown in the multifunction display.

Please respond in accordance with the display messages and follow the additional notes in this Operator's Manual.

Certain display messages are accompanied by an audible warning tone or a continuous tone.

Hiding display messages

You can hide some display messages with a low priority.

▶ Press the , ,  or  button on the steering wheel to select another display.

▶ Press the  reset button on the instrument cluster (▷ page 29).

The display message is cleared.



Display messages with a high priority are shown in red.

You cannot hide display messages of the highest priority. The multifunction display shows these messages continuously until the causes for the messages have been remedied.

Message memory menu

The on-board computer saves certain display messages. You can call up the display messages in the **message memory** menu.

The **message memory** menu is only shown if any display messages have been stored.

▶ Press the  or  button repeatedly, until either the original menu or the **message memory** menu is shown.

If there are display messages, the multifunction display shows, for example, **2 Messages**.

▶ Press the  or  button to scroll through the display messages.

When the ignition is switched off, all display messages are deleted apart from some high-priority display messages. Once the causes of the high-priority display messages have been rectified, the corresponding display messages are also deleted.

Safety systems

Display messages



Unavailable See
Operator's Manual

Possible causes/consequences and ► Solutions

Risk of accident

ABS (Anti-lock Braking System), ESP® (Electronic Stability Program), BAS (Brake Assist), PRE-SAFE®, hill start assist and ESP® trailer stabilization are temporarily not available.

In addition, the , and warning lamps light up in the instrument cluster.

The self-diagnosis function might not be complete, for example.

The brake system continues to function normally, but without the functions listed above. The wheels could therefore lock if you brake hard, for example.

- Carefully drive a suitable distance making slight steering movements at a speed above 12 mph (20 km/h).
If the display message disappears, the functions mentioned above are available again.

If the display message continues to be displayed:

- Drive on carefully.
- Visit a qualified specialist workshop.

Risk of accident

ABS, ESP®, BAS, PRE-SAFE®, hill start assist and ESP® trailer stabilization are temporarily not available.

In addition, the , and warning lamps light up in the instrument cluster.













For example, the on-board voltage may be insufficient.













The brake system continues to function normally, but without the functions listed above. The wheels could therefore lock if you brake hard, for example.





- Drive on carefully.
If the display message disappears, the functions mentioned above are available again.

If the display message continues to be displayed:

- Drive on carefully.
- Visit a qualified specialist workshop.

Display messages	Possible causes/consequences and ► Solutions
 <p>Inoperative See Operator's Manual</p>	<p> Risk of accident</p> <p>ABS, ESP®, BAS, PRE-SAFE®, hill start assist and ESP® trailer stabilization are not available due to a malfunction.</p> <p>The BRAKE (USA only)/ (Canada only), ,  and  warning lamps in the instrument cluster also light up.</p> <p>The brake system continues to function normally, but without the functions listed above. The wheels could therefore lock if you brake hard, for example.</p> <ul style="list-style-type: none"> ► Drive on carefully. ► Visit a qualified specialist workshop immediately.
 <p>Unavailable See Operator's Manual</p>	<p> Risk of accident</p> <p>ESP®, PRE-SAFE® and BAS, hill start assist and ESP® trailer stabilization are temporarily not available.</p> <p>In addition, the  and  warning lamps light up in the instrument cluster.</p> <p>The self-diagnosis function might not be complete, for example. The brake system continues to function normally, but without the functions listed above.</p> <ul style="list-style-type: none"> ► Carefully drive on a suitable stretch of road, making slight steering movements, at a speed above 20 km/h. If the display message disappears, ESP® is available again. If the display message disappears, the functions mentioned above are available again. <p>If the display message continues to be displayed:</p> <ul style="list-style-type: none"> ► Drive on carefully. ► Visit a qualified specialist workshop. <hr/> <p>ESP®, PRE-SAFE® and BAS, hill start assist and ESP® trailer stabilization are temporarily not available.</p> <p>In addition, the  and  warning lamps light up in the instrument cluster.</p> <p>For example, the on-board voltage may be insufficient. The brake system continues to function normally, but without the functions listed above.</p> <ul style="list-style-type: none"> ► Drive on carefully. ► Visit a qualified specialist workshop immediately.





Display messages	Possible causes/consequences and ► Solutions
	<p>If the display message is shown while the vehicle is in motion and the  warning lamp flashes, the electronic traction system is deactivated. Otherwise, the brakes on the drive wheels could overheat.</p> <ul style="list-style-type: none"> ► Let the brakes cool down until the display message disappears and the  warning lamp goes out. The electronic traction system is active again.
 Inoperative See Operator's Manual	<p> Risk of accident</p> <p>ESP®, PRE-SAFE® and BAS, hill start assist and ESP® trailer stabilization are not available due to a malfunction.</p> <p>In addition, the  and  warning lamps light up in the instrument cluster.</p> <p>The brake system continues to function normally, but without the functions listed above.</p> <ul style="list-style-type: none"> ► Drive on carefully. ► Visit a qualified specialist workshop immediately.
  Inoperative See Operator's Manual	<p> Risk of accident</p> <p>EBD (electronic brake force distribution), ABS, ESP®, BAS, PRE-SAFE®, hill start assist and ESP® trailer stabilization are not available due to a malfunction.</p> <p>In addition, the ,  and  warning lamps light up in the instrument cluster and a warning tone sounds.</p> <p>The brake system continues to function normally, but without the functions listed above. The wheels could therefore lock if you brake hard, for example.</p> <ul style="list-style-type: none"> ► Drive on carefully. ► Visit a qualified specialist workshop immediately.
 Brake Wear	<p>The brake pads/linings have reached their wear limit.</p> <ul style="list-style-type: none"> ► Visit a qualified specialist workshop.

Display messages	Possible causes/consequences and ► Solutions
<p>BRAKE (USA only)  (Canada only)</p> <p>Release Parking Brake</p>	<p>You are driving with the parking brake applied. A warning tone also sounds.</p> <ul style="list-style-type: none"> ► Release the parking brake
<p>BRAKE (USA only)  (Canada only)</p> <p>Check Brake Fluid Level</p>	<p> Risk of accident</p> <p>There is not enough brake fluid in the brake fluid reservoir. Additionally, the red BRAKE (USA only)/  (Canada only) warning lamp lights up in the instrument cluster and a warning tone sounds.</p> <ul style="list-style-type: none"> ► Pull over and stop the vehicle safely as soon as possible, paying attention to road and traffic conditions. Do not continue driving under any circumstances. ► Engage the parking brake. ► Consult a qualified specialist workshop. ► Do not add brake fluid. This will not correct the malfunction.

 **WARNING**

Driving with the message **Check Brake Fluid Level** displayed can result in an accident. Have your brake system checked immediately.



Do not add brake fluid before checking the brake system. Overfilling the brake fluid reservoir can result in spilling brake fluid on hot engine parts and the brake fluid catching fire. You can be seriously burned.

Display messages	Possible causes/consequences and ► Solutions
 Tele Aid Inoperative	USA only: one or more of the main functions in the mbrace system are malfunctioning. Canada only: one or more of the main functions of the TELEAID system are malfunctioning. ► USA only: have the mbrace system checked at a qualified specialist workshop. ► Canada only: have the TELEAID system checked at a qualified specialist workshop.
PRE-SAFE Inoperative See Operator's Manual	 Risk of injury Important functions of PRE-SAFE® have failed. All other occupant safety systems, e.g. air bags, remain available. ► Visit a qualified specialist workshop immediately.
 Restraint Sys. Malfunction Service Required	 Risk of injury There is a malfunction in the SRS (Supplemental Restraint System). ► Visit a qualified specialist workshop immediately.

 **WARNING**

In the event a malfunction of the SRS is indicated as outlined above, the SRS may not be operational.



For your safety, we strongly recommend that you contact an authorized Mercedes-Benz Center immediately to have the system checked. Otherwise the SRS may not be activated when needed in an accident, which could result in serious or fatal injury, or it might deploy unexpectedly and unnecessarily which could also result in injury.

Display messages	Possible causes/consequences and ► Solutions
<p>Front Passenger Airbag Enabled See Operator's Manual</p>	<p>The front-passenger air bag is enabled during the journey, even though:</p> <ul style="list-style-type: none"> • a child, a small adult or an object weighing less than the system's weight threshold is located on the front-passenger seat. • the front-passenger seat is unoccupied. <p>The system may detect objects or forces applying additional weight on the seat.</p> <ul style="list-style-type: none"> ► Pull over and stop the vehicle safely as soon as possible, paying attention to road and traffic conditions. ► Engage the parking brake. ► Switch off the ignition. ► Open the front-passenger door. ► Remove the child and the child restraint system from the front-passenger seat. ► If necessary, secure the child in a child restraint system on a suitable rear seat. ► Make sure that no objects are exerting force on the seat, e.g.: <ul style="list-style-type: none"> • trapped books, bags, etc. lying on, behind or beside the seat • head restraints pressing against the headliner <p>The system may otherwise detect these forces and interpret the seat occupant's weight as greater than it actually is.</p> <ul style="list-style-type: none"> ► Keep the seat unoccupied, close the front-passenger door and switch on the ignition. <p>Observe the  PASS AIR BAG OFF (► page 44) indicator lamp and the multifunction display and check the following:</p> <p>Seat unoccupied and ignition switched on:</p> <ul style="list-style-type: none"> • the  PASS AIR BAG OFF indicator lamp must light up and remain lit. When the indicator lamp is on, OCS (► page 44) has deactivated the front-passenger air bag. • the Front Passenger Airbag Enabled See Operator's Manual or Front Passenger Airbag Disabled See Operator's Manual display messages must not appear in the multifunction display. Wait for a period of at least 60 seconds until the necessary system checks have been completed and to make sure that the display messages do not appear in the multifunction display. <p>If these conditions are met, the front-passenger seat can be occupied again. Whether the  PASS AIR BAG OFF indicator lamp remains lit or goes out depends on how OCS classifies the occupant.</p> <p>If the conditions are not met, the system is not operating correctly.</p>

Display messages	Possible causes/consequences and ► Solutions
	► Visit a qualified specialist workshop immediately.

 **WARNING**

If the  **PASS AIR BAG OFF** indicator lamp remains off even after performing the above corrective steps, do not have any children 12 years old and under and other small individuals use the front-passenger seat until the system has been repaired.





Display messages	Possible causes/consequences and ► Solutions
<p>Front Passenger Airbag Disabled See Operator's Manual</p>	<p>The front-passenger air bag is deactivated during the journey even though an adult or a person larger than a certain size is occupying the front-passenger seat. If additional forces are applied to the seat, the system may interpret the occupant's weight as lower than it actually is.</p> <ul style="list-style-type: none"> ► Pull over and stop the vehicle safely as soon as possible, paying attention to road and traffic conditions. ► Engage the parking brake. ► Switch off the ignition. ► Have the occupant get out of the vehicle. ► Set the seat higher (► page 98). ► Make sure that no objects are exerting force on the seat, e.g. books, bags etc. lying under, behind or beside the seat. These forces may otherwise cause the system to detect too low a weight and interpret the seat occupant's weight as less than it actually is. ► Keep the seat unoccupied, close the front-passenger door and switch on the ignition. <p>Observe the  PASS AIR BAG OFF (► page 44) indicator lamp and the multifunction display and check the following:</p> <p>Seat unoccupied and ignition switched on:</p> <ul style="list-style-type: none"> • the  PASS AIR BAG OFF indicator lamp must light up and remain lit. When the indicator lamp is on, OCS (► page 44) has deactivated the front-passenger air bag. • the Front Passenger Airbag Enabled See Operator's Manual or Front Passenger Airbag Disabled See Operator's Manual display messages must not appear in the multifunction display. Wait for a period of at least 60 seconds until the necessary system checks have been completed and to make sure that the display messages do not appear in the multifunction display. <p>If these conditions are met, the front-passenger seat can be occupied again. Whether the  PASS AIR BAG OFF indicator lamp remains lit or goes out depends on how OCS classifies the occupant.</p> <p>If the conditions are not met, the system is not operating correctly.</p> <ul style="list-style-type: none"> ► Visit a qualified specialist workshop immediately.







 **WARNING**







If the  **PASS AIR BAG OFF** indicator lamp remains lit with an adult occupant on the front-passenger seat even after performing the above corrective steps, do not have any passenger use the front-passenger seat until the system has been repaired.



Lights**i** Display messages about LEDs:

This display message will only appear if all LEDs have failed.

Display messages	Possible causes/consequences and ► Solutions
 Low Beam Left or Low Beam Right	The left or right-hand low-beam headlamp is defective. ► Check whether you are permitted to change the bulb yourself (▷ page 119). or ► Visit a qualified specialist workshop.
 Trailer Tail Lamp Left or Trailer Tail Lamp Right	The left or right-hand trailer tail lamp is faulty. ► Check whether you are permitted to change the bulb yourself. or ► Visit a qualified specialist workshop.
 Trailer Turn Signal Left or Trailer Turn Signal Right	The left or right-hand trailer turn signal lamp is defective. ► Check whether you are permitted to change the bulb yourself. or ► Visit a qualified specialist workshop.
 Trailer Brake Lamp	The trailer brake lamp is defective. ► Check whether you are permitted to change the bulb yourself. or ► Visit a qualified specialist workshop.
 Turn Signal Rear Left or Turn Signal Rear Right	The rear left-hand or rear right-hand turn signal is defective. ► Check whether you are permitted to change the bulb yourself (▷ page 119). or ► Visit a qualified specialist workshop.

Display messages	Possible causes/consequences and ► Solutions
 Turn Signal Front Left or Turn Signal Front Right	The front left-hand or front right-hand turn signal is defective. ► Check whether you are permitted to change the bulb yourself (▷ page 119). or ► Visit a qualified specialist workshop.
 Turn Signal Left Mirror or Turn Signal Right Mirror	The turn signal in the left-hand or right-hand exterior mirror is defective. ► Check whether you are permitted to change the bulb yourself (▷ page 119). or ► Visit a qualified specialist workshop.
 3rd Brake Lamp	The high-mounted brake lamp is faulty. ► Check whether you are permitted to change the bulb yourself (▷ page 119). or ► Visit a qualified specialist workshop.
 Brake Lamp Left or Brake Lamp Right	The left or right-hand brake lamp is defective. ► Check whether you are permitted to change the bulb yourself (▷ page 119). or ► Visit a qualified specialist workshop.
 High Beam Left or High Beam Right	The left or right-hand high beam is defective. ► Check whether you are permitted to change the bulb yourself (▷ page 119). or ► Visit a qualified specialist workshop.
 License Plate Lamp Left or License Plate Lamp Right	The left or right-hand license plate lamp is defective. ► Check whether you are permitted to change the bulb yourself (▷ page 119). or ► Visit a qualified specialist workshop.

Display messages	Possible causes/consequences and ► Solutions
 <p>Front Foglamp Left or Front Foglamp Right</p>	<p>The left-hand or right-hand front fog lamp is defective.</p> <ul style="list-style-type: none"> ► Check whether you are permitted to change the bulb yourself (▷ page 119). <p>or</p> <ul style="list-style-type: none"> ► Visit a qualified specialist workshop.
 <p>Foglamp Rear Left or Foglamp Rear Right</p>	<p>The left-hand or right-hand rear fog lamp is defective.</p> <ul style="list-style-type: none"> ► Check whether you are permitted to change the bulb yourself (▷ page 119). <p>or</p> <ul style="list-style-type: none"> ► Visit a qualified specialist workshop.
 <p>Standing Lamp Front Left or Standing Lamp Front Right</p>	<p>The front left or front right standing lamp is defective.</p> <ul style="list-style-type: none"> ► Check whether you are permitted to change the bulb yourself (▷ page 119). <p>or</p> <ul style="list-style-type: none"> ► Visit a qualified specialist workshop.
 <p>Reverse Lamp Left or Reverse Lamp Right</p>	<p>The left or right-hand backup lamp is defective.</p> <ul style="list-style-type: none"> ► Check whether you are permitted to change the bulb yourself (▷ page 119). <p>or</p> <ul style="list-style-type: none"> ► Visit a qualified specialist workshop.
 <p>Marker Lamp Front Left or Marker Lamp Front Right</p>	<p>The left or right front side marker lamp is defective.</p> <ul style="list-style-type: none"> ► Check whether you are permitted to change the bulb yourself (▷ page 119). <p>or</p> <ul style="list-style-type: none"> ► Visit a qualified specialist workshop.
 <p>Tail Lamp Left or Tail Lamp Right</p>	<p>The left or right-hand tail lamp is defective.</p> <ul style="list-style-type: none"> ► Check whether you are permitted to change the bulb yourself (▷ page 119). <p>or</p> <ul style="list-style-type: none"> ► Visit a qualified specialist workshop.
 <p>Daytime Running Light Left or Daytime Running Light Right</p>	<p>The left or right-hand daytime running lamp is defective.</p> <ul style="list-style-type: none"> ► Check whether you are permitted to change the bulb yourself (▷ page 119). <p>or</p> <ul style="list-style-type: none"> ► Visit a qualified specialist workshop.

Display messages	Possible causes/consequences and ► Solutions
 AUTO Light Inoperative	The light sensor is defective. <ul style="list-style-type: none"> ► Visit a qualified specialist workshop. USA only: <ul style="list-style-type: none"> ► Switch off the daytime running lamps in the on-board computer (> page 206). ► Switch the lights on and off using the light switch.
 Switch Off Lights	The lights are still switched on when you leave the vehicle. A warning tone also sounds. <ul style="list-style-type: none"> ► Turn the light switch to 0 or AUTO. or <ul style="list-style-type: none"> ► If the rear fog lamp is switched on: press the light switch in to the stop.

Engine

Display messages	Possible causes/consequences and ► Solutions
 Top Up Coolant See Operator's Manual	The coolant level is too low. <ul style="list-style-type: none"> ► Add coolant, observing the warning notes when doing so (> page 285). ► If the coolant needs to be refilled more often than usual, have the engine coolant system checked at a qualified specialist workshop.

WARNING

Do not spill antifreeze on hot engine parts. Antifreeze contains ethylene glycol which may burn if it comes into contact with hot engine parts. You could be seriously burned.

! The coolant level is too low. Avoid making long journeys with too little coolant in the cooling system. The engine will otherwise be damaged.

The display messages and the corresponding symbol that indicate that the coolant level is too low must not be ignored.

Display messages



Coolant Stop car,
switch engine off

Possible causes/consequences and ► Solutions

The coolant is too hot.

- Pull over and stop the vehicle safely and switch off the engine, paying attention to road and traffic conditions.
- Make sure that the air supply to the engine radiator is not blocked, e.g. by snow, slush or ice.
- Wait until the display message disappears before restarting the engine. Otherwise, there is a risk of engine damage.
- Pay attention to the coolant temperature display.
- If the temperature increases again, visit a qualified specialist workshop immediately.

The poly-V-belt may have torn.

- Pull over and stop the vehicle safely and switch off the engine, paying attention to road and traffic conditions.
- Open the hood.
- Check whether the poly-V-belt is torn.

If the poly-V-belt is torn:

- ❗ Do not continue driving. The engine could otherwise overheat.
- Consult a qualified specialist workshop.

If the poly-V-belt is OK:

- Wait until the display message disappears before restarting the engine. Otherwise, there is a risk of engine damage.
- Pay attention to the coolant temperature display.
- Visit a qualified specialist workshop.





WARNING

Driving when your engine is overheated can cause some fluids which may have leaked into the engine compartment to catch fire. You could be seriously burned.

Steam from an overheated engine can cause serious burns which can occur just by opening the engine hood. Stay away from the engine if you see or hear steam coming from it.

Stop the vehicle in a safe location away from other traffic. Turn off the engine, get out of the vehicle and do not stand near the vehicle until the engine has cooled down.









- ❗ If the coolant temperature exceeds 248 °F(120 °C) do not continue driving. The engine will otherwise be damaged.





Display messages	Possible causes/consequences and ► Solutions
	<p>The engine fan is defective.</p> <ul style="list-style-type: none"> ► At coolant temperatures under 248 °F (120 °C), drive to the next qualified specialist workshop. ► Avoid subjecting the engine to heavy loads, e.g. driving in mountainous terrain, and stop-and-go traffic.
	<p>The battery is not being charged.</p> <p>Possible causes are:</p> <ul style="list-style-type: none"> • a defective alternator • a torn poly-V-belt • a malfunction in the electronics <ul style="list-style-type: none"> ► Pull over and stop the vehicle safely and switch off the engine, paying attention to road and traffic conditions. ► Open the hood. ► Check whether the poly-V-belt is torn. <p>If the poly-V-belt is torn:</p> <ul style="list-style-type: none"> ❗ Do not continue driving. The engine could otherwise overheat. ► Consult a qualified specialist workshop. <p>If the poly-V-belt is OK:</p> <ul style="list-style-type: none"> ► Visit a qualified specialist workshop.
 <p>Battery / Alternator Stop Vehicle</p>	<p>The battery is defective.</p> <ul style="list-style-type: none"> ► Pull over and stop the vehicle safely as soon as possible, paying attention to road and traffic conditions. Do not continue driving under any circumstances. ► Engage the parking brake. ► Consult a qualified specialist workshop.
 <p>Check engine oil level at next refueling</p>	<p>The oil level is too low.</p> <ul style="list-style-type: none"> ► Check the oil level (► page 283). ► If necessary, add engine oil (► page 284). ► Have the engine checked for leaks if the engine oil needs to be refilled more often than usual.



Information on approved engine oils can be obtained from any qualified specialist workshop or on the Internet at <http://www.mbusa.com> (USA only).

❗ The oil level is too low. Avoid long journeys with too little engine oil. There is a risk of engine damage.

The display messages and the corresponding symbol that indicate that the oil level is too low must not be ignored.

Display messages	Possible causes/consequences and ► Solutions
 Reserve Fuel	<p>The fuel level has dropped into the reserve range.</p> <ul style="list-style-type: none"> ► Refuel at the nearest gas station.
	<p>There is only a very small amount of fuel in the fuel tank.</p> <ul style="list-style-type: none"> ► Refuel at the nearest gas station without fail.
 Gas Cap Open	<p>The fuel system pressure is too low. The fuel filler cap is not closed correctly or the fuel system is leaking.</p> <ul style="list-style-type: none"> ► Check that the fuel filler cap is correctly closed. <p>If the fuel filler cap is not correctly closed:</p> <ul style="list-style-type: none"> ► Close the fuel filler cap. <p>If the fuel filler cap is correctly closed:</p> <ul style="list-style-type: none"> ► Visit a qualified specialist workshop.
 Ultra Low-sulfur Diesel Fuel Only	<p>Vehicles with a diesel engine: the fuel level has fallen below the reserve range.</p> <ul style="list-style-type: none"> ► Refuel at the nearest gas station. ► Only use commercially available vehicular ULTRA-LOW SULFUR HIGHWAY DIESEL FUEL (ULSD, 15 ppm SULFUR MAXIMUM).
 Replace air filter	<p>Vehicles with a diesel engine: the engine air filter is dirty and must be replaced.</p> <ul style="list-style-type: none"> ► Visit a qualified specialist workshop.
 Clean Fuel Filter	<p>Vehicles with a diesel engine: there is water in the fuel filter. The water must be drained off.</p> <ul style="list-style-type: none"> ► Visit a qualified specialist workshop.
 Check Additive See Operator's Manual	<p>The DEF tank is empty.</p> <ul style="list-style-type: none"> ► Have the DEF tank filled as soon as possible at a qualified specialist workshop (► page 161).
 Remaining Starts: 16	<p>The DEF level has fallen to a minimum.</p> <ul style="list-style-type: none"> ► Have the DEF tank filled immediately at a qualified specialist workshop. (► page 161)

Driving systems	
Display messages	Possible causes/consequences and ► Solutions
 Vehicle Rising Wait briefly	The vehicle level is too low when the vehicle is stationary. <ul style="list-style-type: none"> ► Do not pull away. The vehicle level is set when the display message disappears.
 STOP Car Too Low	<p>⚠ Risk of accident</p> You have pulled away while the vehicle level is still too low or AIRMATIC is defective. AIRMATIC sets the vehicle to the selected level after a short period. While the display message is displayed: <ul style="list-style-type: none"> ► Make only slight steering movements. Otherwise, the front fender or the tires could be damaged if the steering movement is too large. ► Listen for scraping sounds. ► Do not drive faster than 50 mph (80 km/h). If the display message continues to be displayed: <ul style="list-style-type: none"> ► Have the vehicle checked at a qualified specialist workshop.
 Level Selection Not Permitted	You cannot change the vehicle level because you are exceeding the permissible speed for the selected vehicle level. <ul style="list-style-type: none"> ► Drive more slowly and then select the desired vehicle level again (► page 180).
 Compressor Cooling Down	You have selected a higher vehicle level. The compressor first needs to cool down because of frequent level changes. <ul style="list-style-type: none"> ► Drive in a manner appropriate for the current vehicle level. ► Make sure that there is sufficient ground clearance. ► Allow the compressor to cool down. When the compressor has cooled down, the display message disappears. The vehicle then continues rising to the selected level.
 Malfunction	AIRMATIC is malfunctioning. <ul style="list-style-type: none"> ► Do not drive faster than 50 mph (80 km/h). ► Make sure that there is sufficient ground clearance. ► Have the vehicle checked at a qualified specialist workshop.

Display messages	Possible causes/consequences and ► Solutions
Blind Spot Assist Currently Unavailable. See Operator's Manual	<p>Blind Spot Assist is temporarily inoperative if:</p> <ul style="list-style-type: none"> • the sensors are dirty. • its function is impaired due to heavy rain or snow. • the radar sensor system is outside the operating temperature range. • the radar sensor system is temporarily inoperative, e.g. due to electromagnetic radiation emitted by nearby TV or radio stations or other sources of electromagnetic radiation. <p>The yellow  indicator lamps also light up in the exterior mirrors.</p> <p>Blind Spot Assist is operational again and the display message disappears if:</p> <ul style="list-style-type: none"> • the dirt (e.g. slush) drops away while the vehicle is in motion. • the system detects that the sensors are fully available again. • the radar sensor system is back within the operating temperature range. <p>If the display message continues to be displayed:</p> <ul style="list-style-type: none"> ► Clean the sensors (► page 291). ► Restart the engine.
Blind Spot Assist Inoperative	<p>Blind Spot Assist is defective.</p> <p>The yellow  indicator lamps also light up in the exterior mirrors.</p> <ul style="list-style-type: none"> ► Visit a qualified specialist workshop.
Cruise Control Inoperative	<p>Cruise control is defective.</p> <ul style="list-style-type: none"> ► Visit a qualified specialist workshop.
Cruise Control --- MPH	<p>A condition for activating cruise control has not been fulfilled. You attempted to save a speed of less than 20 mph (30 km/h).</p> <ul style="list-style-type: none"> ► If the situation allows, drive faster than 20 mph (30 km/h) and save the speed. ► Check the activation conditions for cruise control (► page 170).
DISTRONIC --- MPH	<p>An activation condition for DISTRONIC is not fulfilled.</p> <ul style="list-style-type: none"> ► Check the activation conditions for DISTRONIC (► page 173).
DISTRONIC Override	<p>DISTRONIC is no longer controlling the speed of the vehicle.</p> <ul style="list-style-type: none"> ► Take your foot off the accelerator pedal.

Display messages	Possible causes/consequences and ► Solutions
DISTRONIC Inoperative	DISTRONIC is defective or the display has failed. ► Visit a qualified specialist workshop.
DISTRONIC Currently Unavailable See Operator's Manual	DISTRONIC is deactivated and is temporarily inoperative if: <ul style="list-style-type: none"> • the DISTRONIC cover in the radiator grill is dirty. • its function is impaired due to heavy rain, snow or fog. • the radar sensor system is temporarily inoperative, e.g. due to electromagnetic radiation emitted by nearby TV or radio stations or other sources of electromagnetic radiation. • the radar sensor system has not detected any vehicles or stationary objects, e.g. traffic signs, for a long time. • the system is outside the operating temperature range. DISTRONIC becomes available again and the display message disappears if: <ul style="list-style-type: none"> • the dirt (e.g. slush) drops away while the vehicle is in motion. • the system detects that the sensors are fully available again. • the system is within the operating temperature range. If the display message continues to be displayed: <ul style="list-style-type: none"> ► Clean the DISTRONIC cover in the radiator grill (► page 291). ► Restart the engine.

 **WARNING**

DISTRONIC cannot take weather conditions into account. Switch off DISTRONIC or do not turn it on if the sensor is dirty or visibility is diminished as a result of snow, rain or fog. The distance control may be impaired even before the system is able to detect a dirty sensor. The **DISTRONIC Currently Unavailable See Operator's Manual** message will be displayed in the multifunction display and DISTRONIC will be turned off.

Tires

 **WARNING**

Do not drive with a flat tire. A flat tire affects the ability to steer or brake the vehicle. You may lose control of the vehicle. Continued driving with a flat tire will cause excessive heat build-up and possibly a fire.





 **WARNING**



Follow recommended tire inflation pressures.

Do not underinflate tires. Underinflated tires wear excessively and/or unevenly, adversely affect handling and fuel economy, and are more likely to fail from being overheated.

Do not overinflate tires. Overinflated tires can adversely affect handling and ride comfort, wear unevenly, increase stopping distance, and result in sudden deflation (blowout) because they are more likely to become punctured or damaged by road debris, potholes etc.





Display messages	Possible causes/consequences and ► Solutions
Tire Pressure Check Tires	<p> Risk of accident</p> <p>The tire pressure loss warning system has detected a significant loss in pressure.</p> <ul style="list-style-type: none"> ► Stop the vehicle without making any sudden steering or braking maneuvers. Pay attention to the traffic conditions as you do so. ► Check the tires and, if necessary, change the wheel (▷ page 346). ► Check the tire pressures and, if necessary, set to the correct tire pressure. ► Restart the tire pressure loss warning system when the tire pressure is correct (▷ page 329).
Check tires, then restart Run Flat Indicator	<p>The tire pressure loss warning system generated a display message and has not been restarted since.</p> <ul style="list-style-type: none"> ► Set the correct tire pressure in all four tires. ► Restart the tire pressure loss warning system (▷ page 329).
Run Flat Indicator Inoperative	<p>The tire pressure loss warning system is defective.</p> <ul style="list-style-type: none"> ► Visit a qualified specialist workshop.
Tire pressure displayed after driving for a few minutes	<p>The tire pressure monitor is measuring the tire pressure.</p> <ul style="list-style-type: none"> ► Drive on. The tire pressures appear in the multifunction display after you have been driving for a few minutes.
Tire Pressure Monitor Inoperative	<p>The tire pressure monitor is defective.</p> <ul style="list-style-type: none"> ► Visit a qualified specialist workshop.
Tire Pressure Monitor Inoperative No Wheel Sensors	<p>The wheels mounted do not have a suitable tire pressure sensor. The tire pressure monitor is deactivated.</p> <ul style="list-style-type: none"> ► Mount wheels with suitable tire pressure sensors. The tire pressure monitor is activated automatically after driving for a few minutes.



Display messages	Possible causes/consequences and ► Solutions
Check Tire(s)	<p> Risk of accident</p> <p>The tire pressure in one or more tires has dropped significantly. The wheel position is displayed in the multifunction display.</p> <ul style="list-style-type: none"> ► Stop the vehicle without making any sudden steering or braking maneuvers. Pay attention to the traffic conditions as you do so. ► Correct the tire pressure (▷ page 331). ► If necessary, change a wheel (▷ page 346).
Caution: Tire Defect	<p> Risk of accident</p> <p>The tire pressure in one or more tires has dropped suddenly. The wheel position is displayed in the multifunction display.</p> <ul style="list-style-type: none"> ► Stop the vehicle without making any sudden steering or braking maneuvers. Pay attention to the traffic conditions as you do so. ► If necessary, change a wheel (▷ page 346).
Tire Pressure(s) Please Correct	<p>The tire pressure is too low in at least one of the tires or the tire pressure difference between the wheels is too great.</p> <ul style="list-style-type: none"> ► Check the tire pressures at the next opportunity. If necessary, correct the tire pressure (▷ page 331). ► Restart the tire pressure monitor (▷ page 333).
Tire Pressure Monitor Wheel Sensor Missing	<p>There is no signal from the tire pressure sensor of one or several wheels. The pressure of the affected tire is not displayed in the multifunction display.</p> <ul style="list-style-type: none"> ► Have the defective tire pressure sensor replaced at a qualified specialist workshop.
Tire Pressure Monitor Currently Unavailable	<p>Due to a source of radio interference, no signals can be received from the wheel sensors. The tire pressure monitor is temporarily malfunctioning.</p> <ul style="list-style-type: none"> ► Drive on. The tire pressure monitor restarts automatically as soon as the problem has been solved.
 Tire Pressure Caution: Tire Defect	<p> Risk of accident</p> <p>The tire pressure in one or more tires has dropped suddenly.</p> <ul style="list-style-type: none"> ► Stop the vehicle without making any sudden steering or braking maneuvers. Pay attention to the traffic conditions as you do so. ► If necessary, change a wheel (▷ page 346).

Display messages	Possible causes/consequences and ► Solutions
 Tire Pressure Check Tires	<p> Risk of accident</p> <p>The tire pressure in one or more tires has dropped significantly.</p> <ul style="list-style-type: none"> ► Stop the vehicle without making any sudden steering or braking maneuvers. Pay attention to the traffic conditions as you do so. ► If necessary, change a wheel (▷ page 346). ► Check the tire pressure. If necessary, correct the tire pressure (▷ page 331).
 Please correct the tire pressures	<p>The tire pressure is too low in at least one of the tires or the tire pressure difference between the wheels is too great.</p> <ul style="list-style-type: none"> ► Check the tire pressures at the next opportunity. If necessary, correct the tire pressure (▷ page 331).





Vehicle





Display messages	Possible causes/consequences and ► Solutions
Shift to P or N to start engine.	<p>You have attempted to start the engine with the transmission in position R or D.</p> <ul style="list-style-type: none"> ► Shift the transmission to position P or N.
Auxiliary Battery Malfunction	<p>The auxiliary battery for the automatic transmission is no longer being charged.</p> <ul style="list-style-type: none"> ► Visit a qualified specialist workshop at the next opportunity. ► Until then, set the automatic transmission to position P before you switch off the engine. ► Before leaving the vehicle, apply the parking brake.
Depress brake to shift out of P.	<p>You have attempted to move the transmission selector lever to position D, R or N without depressing the brake pedal.</p> <ul style="list-style-type: none"> ► Depress the brake pedal.
Door Open Vehicle Not In Park	<p>The driver's door is open and the transmission is in position R, N or D.</p> <ul style="list-style-type: none"> ► Shift the transmission to position P. ► Engage the parking brake.

Display messages	Possible causes/consequences and ► Solutions
<p>Drive to workshop without shifting gears.</p>	<p>You cannot change the transmission position due to a malfunction.</p> <p>If transmission position D is selected:</p> <ul style="list-style-type: none"> ► Drive to a qualified specialist workshop without shifting the transmission from position D. <p>If transmission position R, N or P is selected:</p> <ul style="list-style-type: none"> ► Notify a qualified specialist workshop or breakdown service.
<p>Only shift to P when vehicle is at a standstill.</p>	<p>The vehicle is moving.</p> <ul style="list-style-type: none"> ► Pull over and stop the vehicle safely as soon as possible, paying attention to road and traffic conditions. ► Shift the transmission to position P.
	<p> Risk of accident</p> <p>The hood or the tailgate is open.</p> <ul style="list-style-type: none"> ► Pull over and stop the vehicle safely as soon as possible, paying attention to road and traffic conditions. ► Engage the parking brake. ► Close the hood or tailgate. <p>You have attempted to lock the vehicle with KEYLESS-GO while the tailgate or door is open.</p> <ul style="list-style-type: none"> ► Close all the doors and/or the tailgate.
	<p>At least one door is open.</p> <ul style="list-style-type: none"> ► Close all the doors.
 <p>Power Steering Malfunction See Operator's Manual</p>	<p> Risk of accident</p> <p>The power steering assistance is defective. You will need to use more force to steer.</p> <ul style="list-style-type: none"> ► Check whether you are able to apply the extra force required. ► If you are able to steer safely: carefully drive on to a qualified specialist workshop. ► If you are unable to steer safely: do not drive on. Contact the nearest qualified specialist workshop.
<p>No Service</p>	<p>Your vehicle is outside the network provider's transmitter/receiver range.</p> <ul style="list-style-type: none"> ► Wait until the mobile phone operational readiness symbol appears in the multifunction display.

Display messages	Possible causes/consequences and ► Solutions
 Bluetooth ready	The Bluetooth® connection between your mobile phone and COMAND is not activated. ► If desired, activate the Bluetooth® connection between your mobile phone and COMAND (see the separate Operator's Manual).
 Top Up Washer Fluid	The washer fluid level has dropped to approximately 1/3 of the total reservoir capacity. ► Add washer fluid (► page 285).







SmartKey



Display messages	Possible causes/consequences and ► Solutions
 Key Does Not Belong to Vehicle	You have put the wrong SmartKey in the ignition lock. ► Use the correct SmartKey.
 Remove Key	The SmartKey is in the ignition lock. ► Remove the SmartKey.
 You need a new key.	The SmartKey needs to be replaced. ► Visit a qualified specialist workshop.
 Change Key Batteries	The batteries of the KEYLESS-GO key are discharged. ► Change the batteries (► page 76).
 Don't Forget Your Key	The display message is shown for a maximum of 60 seconds and is only a reminder. You have opened the driver's door with the engine switched off. The KEYLESS-GO key is not in the ignition lock. ► Remember to take the KEYLESS-GO key with you when you leave the vehicle.

Display messages	Possible causes/consequences and ► Solutions
 <p data-bbox="211 324 444 383">Key Not Detected (Red display message)</p>	<p data-bbox="468 272 898 301">The KEYLESS-GO key is not in the vehicle.</p> <p data-bbox="468 310 1113 363">If the engine is switched off, you can no longer lock the vehicle centrally or start the engine.</p> <ul style="list-style-type: none"> <li data-bbox="468 378 1131 431">▶ Pull over and stop the vehicle safely as soon as possible, paying attention to road and traffic conditions. <li data-bbox="468 440 760 469">▶ Engage the parking brake. <li data-bbox="468 478 788 507">▶ Locate the KEYLESS-GO key. <p data-bbox="468 526 1131 580">The KEYLESS-GO key is not detected while the engine is running because there is interference from a strong source of radio waves.</p> <ul style="list-style-type: none"> <li data-bbox="468 594 1131 648">▶ Pull over and stop the vehicle safely as soon as possible, paying attention to road and traffic conditions. <li data-bbox="468 657 760 686">▶ Engage the parking brake. <li data-bbox="468 695 1087 723">▶ Operate the vehicle with the SmartKey in the ignition lock.
 <p data-bbox="211 797 418 885">Key Not Detected (White display message)</p>	<p data-bbox="468 745 1008 774">The KEYLESS-GO key cannot be detected at present.</p> <ul style="list-style-type: none"> <li data-bbox="468 783 1131 836">▶ Change the location of the key with the KEYLESS-GO functions in the vehicle. <p data-bbox="468 856 911 885">If the KEYLESS-GO key is still not detected:</p> <ul style="list-style-type: none"> <li data-bbox="468 899 1131 953">▶ Change the location of the key with the KEYLESS-GO functions in the vehicle. <li data-bbox="468 962 1087 990">▶ Operate the vehicle with the SmartKey in the ignition lock.
 <p data-bbox="211 1062 405 1121">Key Detected in Vehicle</p>	<p data-bbox="468 1010 1131 1064">The KEYLESS-GO key has been detected inside the vehicle during locking.</p> <ul style="list-style-type: none"> <li data-bbox="468 1078 971 1107">▶ Remove the KEYLESS-GO key from the vehicle.
 <p data-bbox="211 1191 405 1279">Pull starting button out then insert key.</p>	<p data-bbox="468 1139 1040 1168">The KEYLESS-GO key can continuously not be detected.</p> <ul style="list-style-type: none"> <li data-bbox="468 1177 1089 1231">▶ Insert the SmartKey into the ignition lock and turn it to the desired position. <li data-bbox="468 1240 863 1268">▶ Visit a qualified specialist workshop.



Warning and indicator lamps in the instrument cluster

Seat belts

Problem	Possible causes/consequences and ► Solutions
 <p>After starting the engine, the red seat belt warning lamp lights up for six seconds.</p>	<p>The seat belt warning lamp reminds the driver and front passenger to fasten their seat belts.</p> <p>► Fasten your seat belt (▷ page 51).</p>
 <p>After starting the engine, the red seat belt warning lamp lights up. In addition, a warning tone sounds for up to six seconds.</p>	<p> Risk of injury</p> <p>The driver's seat belt is not fastened.</p> <p>► Fasten your seat belt (▷ page 51). The warning tone ceases.</p>
 <p>The red seat belt warning lamp lights up after the engine starts, as soon as the driver's or the front-passenger door is closed.</p>	<p> Risk of injury</p> <p>The driver or front passenger has not fastened their seat belt.</p> <p>► Fasten your seat belt (▷ page 51). The warning lamp goes out.</p> <p> Risk of injury</p> <p>There are objects on the front-passenger seat.</p> <p>► Remove the objects from the front-passenger seat and stow them in a secure place. The warning lamp goes out.</p>

Problem	Possible causes/consequences and ► Solutions
 <p>The red seat belt warning lamp flashes and an intermittent audible warning sounds.</p>	<p> Risk of injury</p> <p>The driver or front passenger has not fastened their seat belt. In addition, you are driving faster than 15 mph (25 km/h) or you have briefly driven faster than 15 mph (25 km/h).</p> <ul style="list-style-type: none"> ► Fasten your seat belt (► page 51). The warning lamp goes out and the intermittent warning tone ceases. <p> Risk of injury</p> <p>There are objects on the front-passenger seat. In addition, you are driving faster than 15 mph (25 km/h) or you have briefly driven faster than 15 mph (25 km/h).</p> <ul style="list-style-type: none"> ► Remove the objects from the front-passenger seat and stow them in a secure place. The warning lamp goes out and the intermittent warning tone ceases.





Safety systems











Problem	Possible causes/consequences and ► Solutions
<p> (USA only)  (Canada only)</p> <p>The red brake system warning lamp comes on while the engine is running. A warning tone also sounds.</p>	<p> Risk of accident</p> <p>There is not enough brake fluid in the brake fluid reservoir.</p> <ul style="list-style-type: none"> ► Pull over and stop the vehicle safely as soon as possible, paying attention to road and traffic conditions. Do not continue driving under any circumstances. ► Engage the parking brake. ► Consult a qualified specialist workshop immediately. ► Observe the additional display messages in the multifunction display. <p>Do not add brake fluid. This will not correct the malfunction.</p>







WARNING





Driving with the brake warning lamp illuminated can result in an accident. Have your brake system checked immediately if the brake warning lamp stays on. Do not add brake fluid before checking the brake system.

Overfilling the brake fluid reservoir can result in spilling brake fluid on hot engine parts and the brake fluid catching fire. You can be seriously burned.

Problem	Possible causes/consequences and ► Solutions
 <p>The yellow ABS warning lamp is lit while the engine is running.</p>	<p> Risk of accident</p> <p>ABS (Anti-lock Brake System) is deactivated due to a malfunction. ESP® (Electronic Stability Program), BAS (Brake Assist), PRE-SAFE®, hill start assist and ESP® trailer stabilization, for example, are therefore also deactivated.</p> <p>The brake system continues to function normally, but without the functions listed above. The wheels could therefore lock if you brake hard, for example.</p> <ul style="list-style-type: none"> ► Observe the additional display messages in the multifunction display. ► Drive on carefully. ► Visit a qualified specialist workshop. <p>If the ABS control unit is faulty, there is also a possibility that other systems, such as the navigation system or the automatic transmission, will not be available.</p>
 <p>The yellow ABS warning lamp is lit while the engine is running.</p>	<p> Risk of accident</p> <p>ABS is temporarily unavailable. ESP®, BAS, EBD (electronic brake force distribution), PRE-SAFE®, hill start assist and ESP® trailer stabilization, for example, are therefore also unavailable.</p> <p>Self diagnosis is not yet complete.</p> <p>or</p> <p>For example, the on-board voltage may be insufficient.</p> <p>The brake system continues to function normally, but without the functions listed above. The wheels could therefore lock if you brake hard, for example.</p> <ul style="list-style-type: none"> ► Carefully drive a suitable distance making slight steering movements at a speed above 12 mph (20 km/h). The functions mentioned above are available again when the warning lamp goes out. <p>If the warning lamp is still on:</p> <ul style="list-style-type: none"> ► Observe the additional display messages in the multifunction display. ► Drive on carefully. ► Visit a qualified specialist workshop.

Problem	Possible causes/consequences and ► Solutions
 <p>The yellow ABS warning lamp is lit while the engine is running. A warning tone also sounds.</p>	<p> Risk of accident</p> <p>EBD is faulty. Therefore, ABS, BAS, PRE-SAFE[®], hill start assist and ESP[®] trailer stabilization, for example, are also not available due to a malfunction.</p> <p>The brake system continues to function normally, but without the functions listed above. The wheels could therefore lock if you brake hard, for example.</p> <ul style="list-style-type: none"> ► Observe the additional display messages in the multifunction display. ► Drive on carefully. ► Visit a qualified specialist workshop.
<p> (USA only)</p> <p> (Canada only)</p> <p>  </p> <p>The red brake warning lamp, the yellow ESP[®] and ESP[®] OFF warning lamps and the yellow ABS warning lamp are lit while the engine is running.</p>	<p> Risk of accident</p> <p>ABS and ESP[®] are faulty. As a result other systems, such as, BAS, EBD, PRE-SAFE[®], hill start assist and ESP[®] trailer stabilization..., may also be unavailable due to a malfunction.</p> <p>The brake system continues to function normally, but without the functions listed above. The wheels could therefore lock if you brake hard, for example.</p> <ul style="list-style-type: none"> ► Observe the additional display messages in the multifunction display. ► Drive on carefully. ► Visit a qualified specialist workshop.
<p></p> <p>The yellow ESP[®] warning lamp flashes while the vehicle is in motion.</p>	<p> Risk of accident</p> <p>ESP[®] or traction control has intervened because there is a risk of skidding or at least one wheel has started to spin.</p> <p>Cruise control or DISTRONIC is deactivated.</p> <ul style="list-style-type: none"> ► Only depress the accelerator pedal as far as necessary when pulling away. ► Release the accelerator pedal while the vehicle is in motion. ► Adapt your driving style to suit the road and weather conditions. ► Do not deactivate ESP[®]. <p>For exceptions: (► page 66).</p>





Problem	Possible causes/consequences and ► Solutions
 <p>The yellow ESP[®] warning lamp flashes while the vehicle is in motion.</p>	<p>At least one wheel is spinning and the electronic traction system is deactivated to prevent the brakes on the drive wheels from overheating.</p> <ul style="list-style-type: none"> ► Observe the additional display messages in the multifunction display. <p>The electronic traction system switches back on again as soon as the brakes have cooled down.</p> <p>The display message disappears and the  warning lamp goes out.</p>
 <p>The yellow ESP[®] OFF warning lamp is lit while the engine is running.</p>	<p> Risk of accident</p> <p>ESP[®] and ESP[®] trailer stabilization are deactivated. ESP[®] will not stabilize the vehicle if it starts to skid or if a wheel starts to spin.</p> <ul style="list-style-type: none"> ► Reactivate ESP[®]. For exceptions: (> page 66). ► Adapt your driving style to suit the road and weather conditions. <p>If ESP[®] cannot be activated:</p> <ul style="list-style-type: none"> ► Have ESP[®] checked at a qualified specialist workshop.
 <p>The yellow ESP[®] and ESP[®] OFF warning lamps are lit while the engine is running.</p>	<p> Risk of accident</p> <p>ESP[®], BAS, PRE-SAFE[®], hill start assist and ESP[®] trailer stabilization are not available due to a malfunction. ESP[®] will not stabilize the vehicle if it starts to skid or if a wheel starts to spin.</p> <ul style="list-style-type: none"> ► Observe the additional display messages in the multifunction display. ► Drive on carefully. ► Visit a qualified specialist workshop.

Problem	Possible causes/consequences and ► Solutions
<p> (USA only)  (Canada only) The red brake system warning lamp comes on while the vehicle is moving. A warning tone also sounds.</p>	<p>You are driving with the parking brake applied.</p> <ul style="list-style-type: none"> ► Release the parking brake <p>The warning lamp goes out and the warning tone ceases.</p>
<p> The red SRS warning lamp is lit while the engine is running.</p>	<p> Risk of injury</p> <p>The restraint systems are malfunctioning. The air bags or ETDs may either be triggered unintentionally or, in the event of an accident, not be triggered at all.</p> <ul style="list-style-type: none"> ► Drive on carefully. ► Visit a qualified specialist workshop immediately.



 **WARNING**

In the event a malfunction of the SRS is indicated as outlined above, the SRS may not be operational.



For your safety, we strongly recommend that you contact an authorized Mercedes-Benz Center immediately to have the system checked. Otherwise the SRS may not be activated when needed in an accident, which could result in serious or fatal injury, or it might deploy unexpectedly and unnecessarily which could also result in injury.

Engine	
Problem	Possible causes/consequences and ► Solutions
<p> (USA only)  (Canada only)</p> <p>The yellow Check Engine warning lamp lights up while the ignition is switched on with the engine running.</p>	<p>There may be a malfunction, for example:</p> <ul style="list-style-type: none"> • in the engine management • in the fuel injection system • in the exhaust system • in the ignition system (for vehicles with a gasoline engine) • in the fuel system <p>The emission limit values may be exceeded and the engine may be running in emergency mode.</p> <p>► Have the vehicle checked as soon as possible at a qualified specialist workshop.</p> <p>i In some states, you are required by law to immediately visit a qualified specialist workshop as soon as the yellow Check Engine warning lamp lights up. If in doubt, check whether such legal regulations apply in the state/province in which you are currently driving.</p> <p>Vehicles with a diesel engine: the fuel tank has been run dry (► page 160).</p> <p>► Start the engine three to four times after refueling. If the yellow Check Engine warning lamp goes out, emergency running mode is canceled. The vehicle need not be checked.</p>
<p>The yellow reserve fuel warning lamp flashes while the vehicle is in motion.</p> <p>In addition, the  (USA only)/  (Canada only) yellow Check Engine warning lamp may light up.</p>	<p>The fuel system pressure is too low. The fuel filler cap is not closed correctly or the fuel system is leaking.</p> <p>► Observe the additional display messages in the multifunction display.</p> <p>► Check that the fuel filler cap is correctly closed.</p> <p>► If the fuel filler cap is not correctly closed: close the fuel filler cap.</p> <p>► If the fuel filler cap is closed: visit a qualified specialist workshop.</p>
<p>The yellow reserve fuel warning lamp lights up while the engine is running.</p>	<p>The fuel level has dropped into the reserve range.</p> <p>► Refuel at the nearest gas station.</p>

Driving systems

Problem	Possible causes/consequences and ► Solutions
 <p>The red distance warning lamp lights up while the vehicle is in motion. A warning tone also sounds.</p>	<p> Risk of accident</p> <p>The warning is issued if you approach a stationary vehicle or a vehicle driving ahead of you at too high a speed.</p> <ul style="list-style-type: none"> ► Be prepared to brake immediately. ► Pay careful attention to the traffic situation. You may have to brake or take evasive action. <p>More information about DISTRONIC (► page 173) and the distance warning signal (► page 68).</p>

Tires

Problem	Possible causes/consequences and ► Solutions
 <p>USA only: The yellow tire pressure monitor warning lamp (pressure loss/malfunction) is lit.</p>	<p> Risk of accident</p> <p>The tire pressure monitor has detected a loss of pressure in at least one of the tires.</p> <ul style="list-style-type: none"> ► Stop the vehicle without making any sudden steering or braking maneuvers. Pay attention to the traffic conditions as you do so. ► Observe the additional display messages in the multifunction display. ► Check the tire pressure. If necessary, correct the tire pressure (► page 331). ► If necessary, change a wheel (► page 346).
 <p>USA only: The yellow tire pressure monitor warning lamp (pressure loss/malfunction) flashes for 60 seconds and then remains lit.</p>	<p>The tire pressure monitor is defective.</p> <ul style="list-style-type: none"> ► Observe the additional display messages in the multifunction display. ► Visit a qualified specialist workshop.

 **WARNING**

Each tire, including the spare (if provided), should be checked every other week when cold and inflated to the inflation pressure recommended by the vehicle manufacturer on the Tire and Loading Information placard on the driver's door B-pillar or, if available, the tire inflation pressure label on the inside of the fuel filler flap. If your vehicle has tires of a different size than the size

indicated on the Tire and Loading Information placard or, if available, the tire inflation pressure label, you should determine the proper tire inflation pressure for those tires.

As an added safety feature, your vehicle has been equipped with a tire pressure monitoring system (TPMS) that illuminates a low tire pressure warning lamp when one or more of your tires are significantly underinflated. Accordingly, when the low tire pressure warning lamp illuminates, you should stop and check your tires as soon as possible, and inflate them to the proper pressure. Driving on a significantly underinflated tire causes the tire to overheat and can lead to tire failure.

Underinflation also reduces fuel efficiency and tire tread life, and may affect the vehicle's handling and stopping ability. Please note that the TPMS is not a substitute for proper tire maintenance, and it is the driver's responsibility to maintain correct tire pressure, even if underinflation has not reached the level to trigger illumination of the TPMS low tire pressure warning lamp.

Your vehicle has also been equipped with a TPMS malfunction indicator to indicate when the system is not operating properly. The TPMS malfunction indicator is combined with the low tire pressure warning lamp. When the system detects a malfunction, the warning lamp will flash for approximately one minute and then remain continuously illuminated. This sequence will continue upon subsequent vehicle start-ups as long as the malfunction exists. When the malfunction indicator is lit, the system may not be able to detect or signal low tire pressure as intended.

TPMS malfunctions may occur for a variety of reasons, including the installation of incompatible replacement or alternate tires or wheels on the vehicle that prevent the TPMS from functioning properly. Always check the TPMS malfunction warning lamp after replacing one or more tires or wheels on your vehicle to ensure that the replacement or alternate tires and wheels allow the TPMS to continue to function properly.

Useful information	248
Loading guidelines	248
Stowage areas	248
Features	262

Useful information

- i** This Operator's Manual describes all models and all standard and optional equipment of your vehicle available at the time of publication of the Operator's Manual. Country-specific differences are possible. Please note that your vehicle may not be equipped with all features described. This also applies to safety-related systems and functions.
- i** Please read the information on qualified specialist workshops (▷ page 24).

Loading guidelines

WARNING

Always fasten items being carried as securely as possible. Use cargo tie-down rings and fastening materials appropriate for the weight and size of the load.

In an accident, during hard braking or sudden maneuvers, loose items will be thrown around inside the vehicle. This can cause injury to vehicle occupants unless the items are securely fastened in the vehicle.

To help avoid personal injury during a collision or sudden maneuver, exercise care when transporting cargo. Do not pile luggage or cargo higher than the seat backrests.

The cargo compartment is the preferred place to carry objects. Always use cargo tie-down rings, and if so equipped, always use the cargo net when transporting cargo.

Never drive a vehicle with the tailgate open. Deadly carbon monoxide (CO) gases may enter vehicle interior resulting in unconsciousness and death.

The gross vehicle weight (GVW) is the vehicle weight including fuel, vehicle tool kit, spare wheel, installed accessories, vehicle occupants and luggage/cargo.

The gross load limit and the gross vehicle weight rating (GVWR) for your vehicle must

never be exceeded. The gross load limit and the GVWR are specified on the vehicle identification plate on the B-pillar of the driver's door (▷ page 333).

The load must also be distributed so that the weight on each axle never exceeds the gross axle weight rating (GAWR) for the front and rear axles. The specifications for GVWR and GAWR are on the vehicle identification plate on the B-pillar of the driver's door (▷ page 333).

Further information can be found in the "Loading the vehicle" section (▷ page 333).

The handling characteristics of a laden vehicle are dependent on the distribution of the load within the vehicle. For this reason, you should observe the following notes when transporting a load:

- position heavy loads as far forwards as possible and as low down in the cargo compartment as possible.
- the load must not protrude above the upper edge of the seat backrests.
- always place the load against the rear or front seat backrests. Make sure that the seat backrests are securely locked into place.
- hook in the cargo net when loading.
- always place the load behind unoccupied seats if possible.
- secure the load with sufficiently strong and wear-resistant tie down. pad sharp edges for protection.

Stowage areas

Stowage compartments

Important safety notes

WARNING

To help avoid personal injury during a collision or sudden maneuver, exercise care when storing objects in the vehicle. Put luggage or cargo in the cargo compartment if possible.

Do not pile luggage or cargo higher than the seat backrests.

If so equipped, always use the cargo net when transporting cargo. The cargo net cannot secure hard or heavy objects.

Parcel nets cannot secure hard or heavy objects.

Keep compartment lids closed. This will help to prevent stored objects from being thrown about and injuring vehicle occupants during

- braking
- vehicle maneuvers
- an accident

Stowage compartments in the front

Glove box

i Depending on the vehicle's equipment, you will find an AUX IN jack or a Media Interface installed in the glove box. A Media Interface is a universal interface for mobile audio equipment, e.g. for an iPod® or USB device (see the separate COMAND operating instructions).

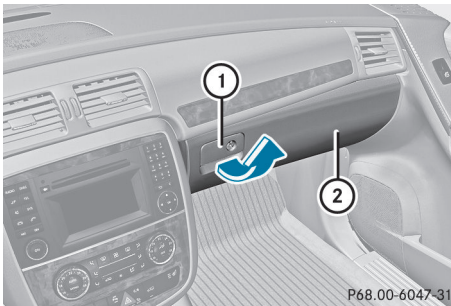

► **To open:** pull handle ① and open glove box flap ②.

► **To close:** fold glove box flap ② upwards until it engages.

The glove box can only be locked and unlocked using the mechanical key.

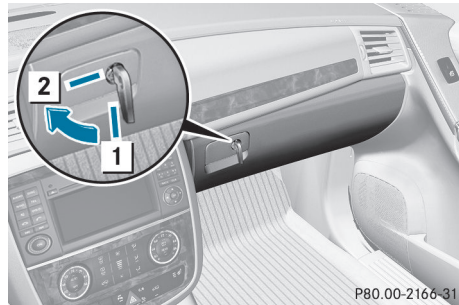

- ① Glove box unlocked
- ② Glove box locked

Stowage compartments in the center console

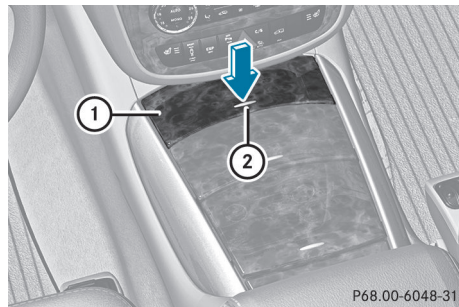

Front stowage compartment

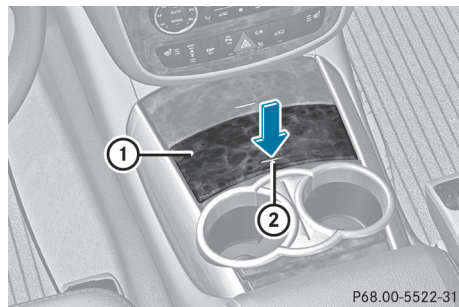

Rear stowage compartment

► Briefly press trim ② in the direction of the arrow.
Cover ① swings upwards.

i In vehicles with the smoker's package, an ashtray is installed instead of the rear stowage compartment (▷ page 265).

Storage compartments under the armrest

The storage compartment and the storage tray can be opened separately.

- i** In vehicles with the Rear Seat Entertainment System, a DVD player is installed in the storage compartment; see the separate operating instructions.

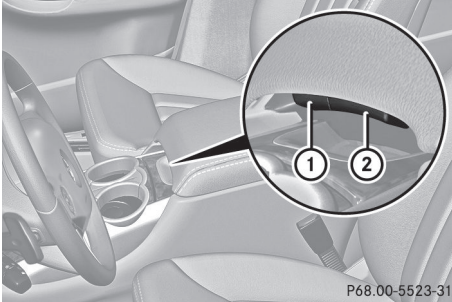

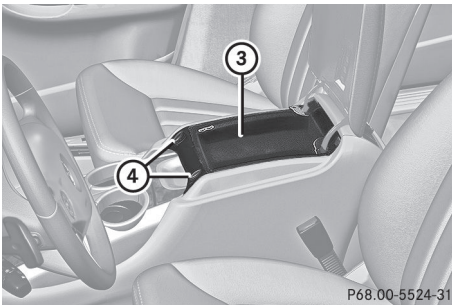

P68.00-5523-31

- ▶ **To open the storage tray:** press release button ① and fold the armrest upwards.
- ▶ **To open the storage compartment:** press release button ② and fold the armrest upwards.



P68.00-5524-31

- ③ Storage tray
- ④ Coin holder

- i** The Roadside Assistance  (▷ page 272) and MB info call  (▷ page 272) buttons are in the storage tray ③ under the armrest.

Storage compartments in the rear

Storage compartments above the center air vents, 2nd row of seats

Depending on the equipment in the vehicle, a control panel may be installed instead of the upper storage compartment, e.g. if the vehicle has rear-compartment air conditioning for the 2nd and 3rd rows of seats.



P68.00-5526-31

Storage compartment in the center console, 2nd row of seats



P68.00-5525-31

- ▶ **To open:** press the release button under the armrest and fold the armrest upwards.

Storage compartments in the 3rd row of seats

There is a storage compartment in the side trim on both sides. In vehicles with rear-compartment air conditioning (2nd and 3rd row of seats), a swiveling side air vent is installed instead of the storage compartment.

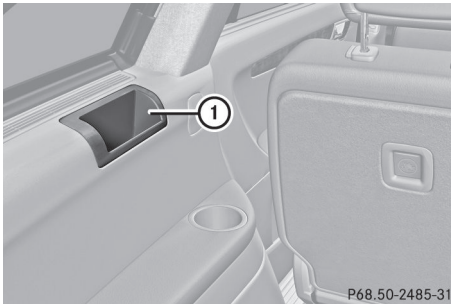

① Stowage compartment

Stowage pockets

WARNING

Storage bags are intended for storing light-weight items only.

Heavy objects, objects with sharp edges or fragile objects may not be transported in the storage bag. In an accident, during hard braking, or sudden maneuvers, they could be thrown around inside the vehicle and cause injury to vehicle occupants.

Storage bags cannot protect transported goods in the event of an accident.

Storage bags are located in the rear compartment on the driver's and front-passenger seat backrests.

Parcel nets

WARNING

Vehicles with Occupant Classification System (OCS)

Do not place objects with a combined weight of more than 4.4 lbs (2 kg) into the parcel net on the back of the front passenger seat. Otherwise, the OCS may not be able to properly approximate the occupant weight category.

WARNING

Parcel nets are intended for storing light-weight items only, such as road maps, mail, etc.

Heavy objects, objects with sharp edges, or fragile objects may not be transported in the parcel nets. In an accident, during hard braking, or sudden maneuvers, they could be thrown around inside the vehicle and cause injury to vehicle occupants.

Parcel nets cannot protect transported goods in the event of an accident.

Parcel nets are located in the front-passenger footwell and on the back of the driver's and the front-passenger seat.

Center console, 2nd row of seats

Removing the center console

WARNING

Remove all containers that may be stored in the cup holder in the rear center console. Otherwise, liquids could spill on the occupants and/or vehicle equipment. Hot fluids spilled on the vehicle occupants may cause serious injury. Liquids spilled on vehicle equipment may cause damage that is not covered by the Mercedes-Benz Limited Warranty.

The center console contains a stowage compartment (▷ page 250) and a cup holder (▷ page 263).

If you are using the fully extended cargo compartment and want an even loading area (▷ page 253), you must remove the center console.

 To avoid damage to the center console or its components, close the stowage compartment before removing the center console.

 Remove all objects from the stowage compartment (▷ page 250) to reduce the weight of the center console.

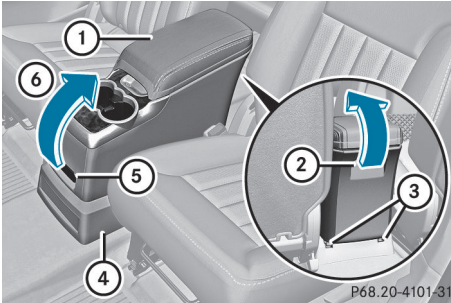

- ▶ Pull release handle (5).
The front part of center console (1) detaches from supporting base (4).
- ▶ Lift center console (1) upwards in the direction of arrow (6) and hold center console (1) in this position.
- ▶ At the same time, reach into recess (2).
- ▶ Lift center console (1) by recess (2) upwards in the direction of the arrow to release center console (1) from anchoring points (3).
- ▶ Remove center console (1) from the vehicle.

i Supporting base (4) cannot be removed.

Installing the center console

⚠ WARNING

The rear center console must be properly attached to the rear center console base when the vehicle is in motion. The rear center console could otherwise come loose. It could be thrown around in the vehicle interior, causing injury to the vehicle occupants during:

- braking
- vehicle maneuvers
- an accident

You can install the center console in two different positions. In the foremost position (position 1) you can extend the cargo compartment fully (> page 253) without removing the center console.

i The stowage compartment and cup holder will only be illuminated if the center console is installed in the rear position (position 0).

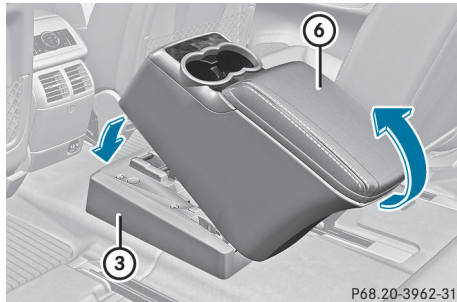
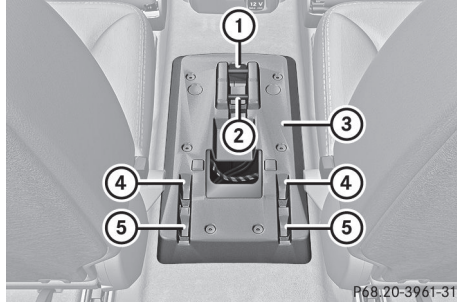

- ▶ Position center console (6) above supporting base (3).
- ▶ Mount the retainers of center console (6) using anchoring points (4) (position 1) or (5) (position 0) of basic carrier (3).
- ▶ Guide the front part of center console (6) downwards in the direction of the arrow to supporting base (3).
Center console (6) must rest on supporting base (3).
- ▶ Push the front part of center console (6) downwards until you hear center console (6) engage in securing rings (1) (position 1) or (2) (position 0).

Cargo compartment enlargement

Important safety notes

WARNING

When expanding the cargo volume, always fully fold the corresponding seats and, if so equipped, always use the cargo net when transporting cargo.

Unless you are transporting cargo, the seat backrests must remain properly locked in the upright position.

In an accident, during hard braking or sudden maneuvers, loose items will be thrown around inside the vehicle. This can cause injury to vehicle occupants unless the items are securely fastened in the vehicle.

Always use the cargo tie-down rings.

WARNING

Never drive a vehicle with the tailgate open. Deadly carbon monoxide (CO) gases may enter vehicle interior resulting in unconsciousness and death.

To enlarge the cargo compartment, the rear bench seats of the second and third rows of seats can be folded forwards separately. You can enlarge the cargo compartment partially (> page 253) or fully (> page 253).

Partially enlarging the cargo compartment (folding the seats in the 3rd row forward)

- ▶ Move the head restraint of the corresponding seat down fully (> page 100).

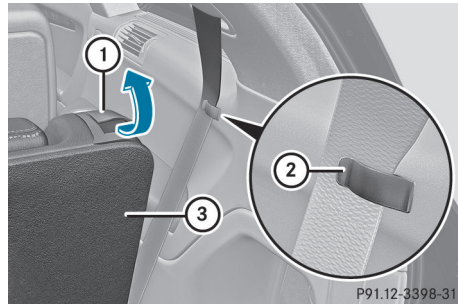

- ▶ Clamp the seat belt behind retainer (2).
- ▶ Pull release handle (1) of backrest (3) upwards in the direction of the arrow. Backrest (3) is released.

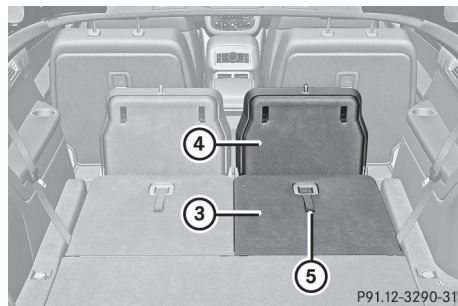

- ▶ Fold backrest (3) slowly forwards. Seat cushion (4) is released and moves automatically to a vertical position.
- ▶ Fold backrest (3) forwards into a horizontal position.

- i** Loop (5) can be used to pull the backrests of the 3rd row of seats upright when the seats are moved into the original position (> page 256).

Enlarging the cargo compartment completely (by folding the 2nd and 3rd row of seats down)

WARNING

Folded second-row seats are intended to serve as a cargo volume expansion in conjunction with folded third-row seats only. Do not fold the second-row seats and allow

third-row seat occupants to use folded second-row seats as a footrest while driving. Third-row seat occupants must, like all vehicle occupants, keep both feet on the floor in front of their seat. Otherwise, occupants could slide under their seat belt in a collision. If occupants slide under the seat belt, it would apply force at the abdomen or neck. That could cause serious or even fatal injuries. Do not fold the second-row seats and allow third-row seat occupants to use folded second-row seats as a table while driving. Objects placed on folded second-row seats may come loose during braking, vehicle maneuvers, or an accident and be thrown around the vehicle interior. Objects thrown around the vehicle interior may cause an accident and/or serious personal injury.

! Make absolutely sure that you adhere to the specified folding order when fully enlarging the cargo compartment:

- fold down the center seat in the 2nd row of seats (7-seat vehicles)
- fold down the outer seats in the 2nd row of seats
- fold down the seats in the 3rd row of seats

You could otherwise damage the seats.

Folding down the center seat in the 2nd row of seats

- !** Close the cup holder in the 2nd row of seats before folding down the 2nd row of seats. You could otherwise damage the seats or cup holder.
- ▶ Lower the head restraint on the center seat in the 2nd row of seats fully (> page 100).

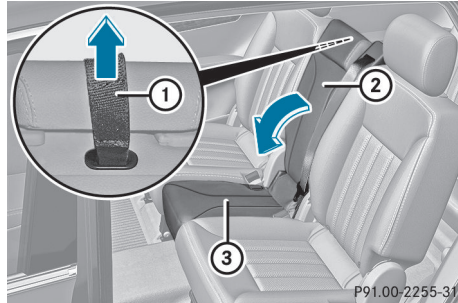

- ▶ Pull release loop ① in the direction of the arrow.
- ▶ Fold backrest ② forwards completely until it is resting on seat cushion ③ (armrest position).

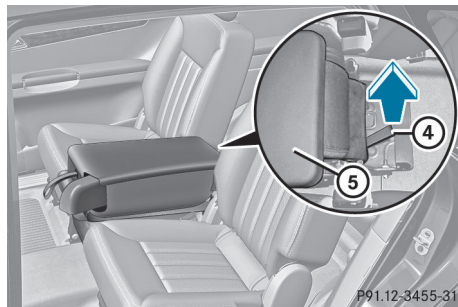

Armrest position

- ▶ Pull release loop ④ in the direction of the arrow and hold it securely. The seat is released and folds up.
- ▶ Press seat ⑤ further down until the front of the seat engages in the trunk floor position.



Trunk floor position

Folding down the outer seats in the 2nd row of seats

! If you want to fold the outer seats down in the 2nd row of seats, the front seats must not be in the rearmost position. Otherwise, you could damage the front seats and outer seats in the 2nd row.

! Close the cup holder in the 2nd row of seats before folding down the 2nd row of seats. You could otherwise damage the seats or cup holder.

- ▶ Move the seat concerned in the 2nd row to its rearmost position (▷ page 101).
- ▶ Remove the center console for the 2nd row of seats, if installed (▷ page 251).

i The center console of the 2nd row of seats can remain installed if it is installed in the front position (position 1) (▷ page 251). However, the loading area will not be level.

- ▶ Remove the head restraint of the seat concerned (▷ page 100).



- ▶ Lay the head restraints on the seat cushion of the corresponding seat.
- ▶ Relieve the pressure on backrest (1) and pull release lever (2) upwards in the direction of the arrow beyond the pressure point to the stop. Backrest (1) and the seat are unlocked.
- ▶ Fold backrest (1) forwards until it is resting horizontally on the seat cushion.



- ▶ Now push backrest (1) down further until seat cushion (2) engages on the floor.

Folding down the seats in the 3rd row of seats

- ▶ Push down the respective head restraints in the 3rd row as far as they will go (▷ page 100).

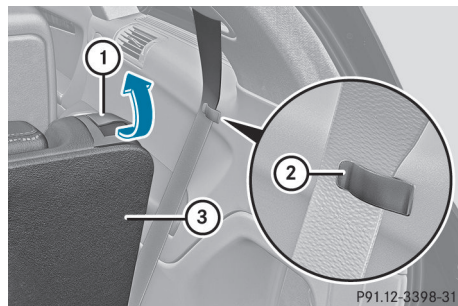

- ▶ Clamp the seat belt behind retainer (2).
- ▶ Pull release handle (1) of backrest (3) upwards in the direction of the arrow. Backrest (3) is released.

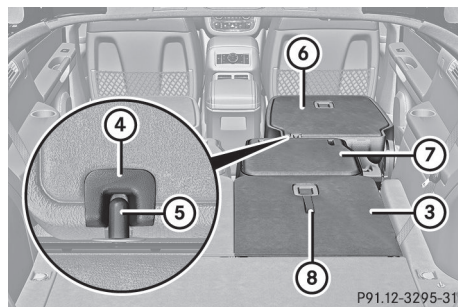

- ▶ Fold backrest ③ slowly forwards. Seat cushion ⑦ is released and moves automatically to a vertical position.
- ❗ Loop ⑧ can be used to pull the backrests of the 3rd row of seats upright when the seats are moved into the original position (▷ page 256).
- ▶ After it has been moved to a vertical position automatically, fold seat cushion ⑦ further forwards until it reaches a horizontal position. In doing so, make sure that guide pin ⑤ of seat cushion ⑦ catches fully in recess ④ of backrest ⑥.
- ❗ The seats in the 2nd row of seats must be in the rearmost position (▷ page 101).
- ▶ Fold backrest ③ forwards into a horizontal position.

Moving the seats back into the driving position

WARNING

Make sure

- the seats are properly locked
- the seat backrests are in an upright position and are properly locked

An outboard second-row seat is properly locked only when lock status indicator ① is in hinged position and red marking ② is barely visible, see "Lock status indicators (outboard second-row seats)".

If a seat and seat backrest are not properly locked, the seat could move forward and the seat backrest could fold. You could slide under the seat belt during braking, vehicle maneuvers, or in an accident. If you slide under it, the belt would apply force at the abdomen or neck. That could cause serious or even fatal injuries.

❗ Make absolutely sure that you reset the seats to the driving position in the specified order:

- reset the seats in the 3rd row of seats
- reset the outer seats in the 2nd row of seats
- reset the center seat in the 2nd row of seats (7-seat vehicles)

Resetting the seats in the 3rd row of seats

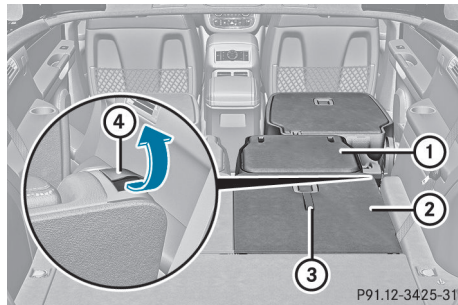

❗ Do not fold down the seat cushions before moving the backrests into the upright position. The seat cover could otherwise be damaged.

- ▶ Grip loop ③ and pull seat backrest ② into an upright position.
- ▶ Pull release handle ④ and move backrest ② to the desired position.
- ▶ Place seat cushion ① in a vertical position.
- ▶ Fold seat cushion ① towards backrest ② until it engages audibly.

Resetting the outer seats in the 2nd row of seats

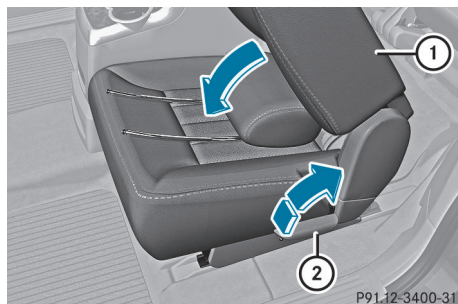

- ▶ Pull release lever ② upwards beyond the pressure point to the stop and fold backrest ① upwards by about 45 °.
- ▶ Insert the head restraint (▷ page 100).
- ▶ Pull release lever ② to the pressure point and adjust backrest ① to the desired position.
- ▶ Check that the seat is correctly engaged.
- ▶ Set the seat head restraint to the desired position (▷ page 100).

Lock verification indicator for the outer seats in the 2nd row of seats

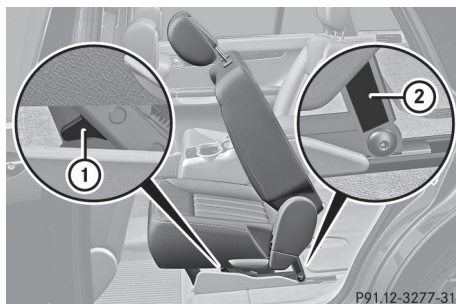

Seat unlocked

When the seat is unlocked, lock status indicator ① is folded out and indicator area ② is clearly visible.

- ▶ When the seat is unlocked, fold the backrest back until you hear the seat engage.

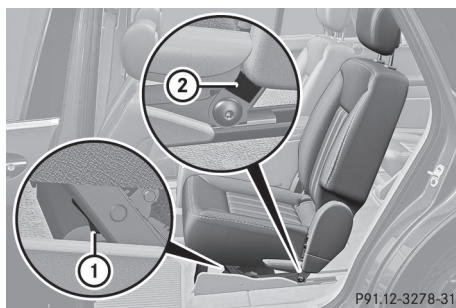

Seat locked

When the seat is locked, lock status indicator ① is folded in and indicator area ② is barely visible.

Resetting the center seat in the 2nd row of seats

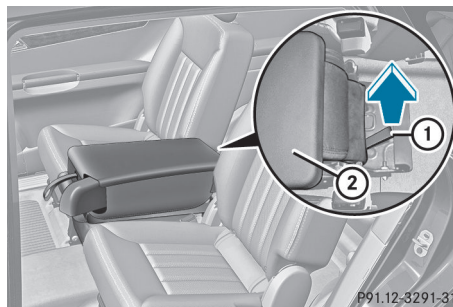

Armrest position

- ▶ Pull release loop ① of seat ② in the direction of the arrow and hold it securely. The seat is released and folds up.
- ▶ Press seat ② further down until the back of the seat engages in the armrest position.
- ▶ Pull release loop ① of the backrest in the direction of the arrow and hold it securely.
- ▶ Fold the backrest backwards until you hear it engage.

Securing cargo

Cargo tie-down rings

Observe the following notes on securing loads:

- secure the load using the cargo tie down rings.
- do not use elastic straps or nets to secure a load, as these are only intended as an anti-slip protection for light loads.
- do not route tie downs across sharp edges or corners.
- pad sharp edges for protection.

Footwell of the second row of seats

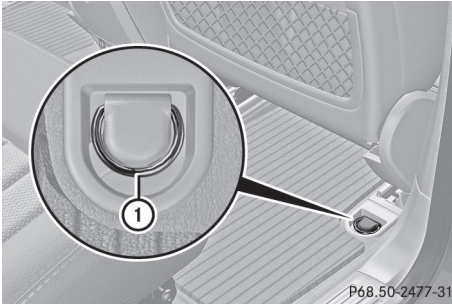

There is one cargo tie-down ring (1) in the footwell behind the driver's seat and one in the footwell behind the front-passenger seat.

Footwell of the third row of seats

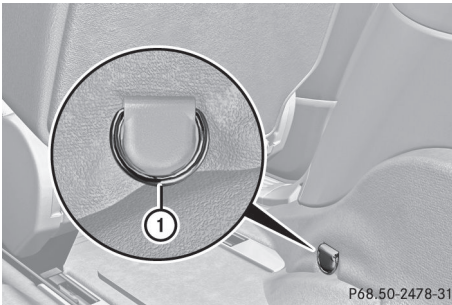

Two cargo tie down rings (1) are located in the footwell of the third row of seats.

Cargo compartment

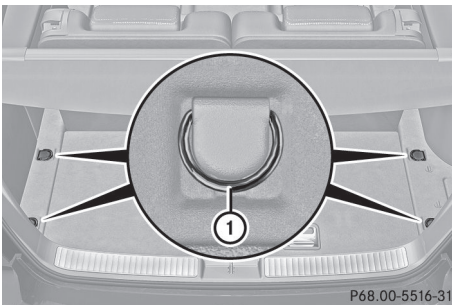

There are four cargo tie down rings (1) in the cargo compartment.

Securing hooks

Only use the mounting hooks to secure items of luggage up to maximum of 9 lbs (4 kg) in weight.

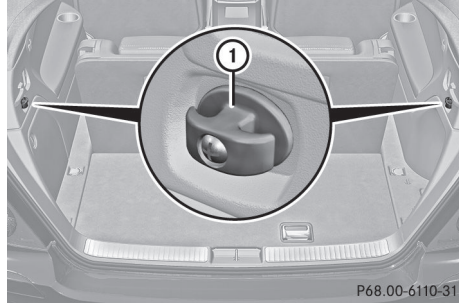

There is a mounting hook (1) on each of the side panels in the cargo compartment.

Cargo compartment cover

Important safety notes

- When loading the vehicle, make sure that you do not stack the load in the cargo compartment higher than the lower edge of the side windows. Do not place heavy objects on top of the cargo compartment cover.

The cargo compartment cover can be attached behind the second or third row of seats.

Extending and retracting the cargo compartment cover

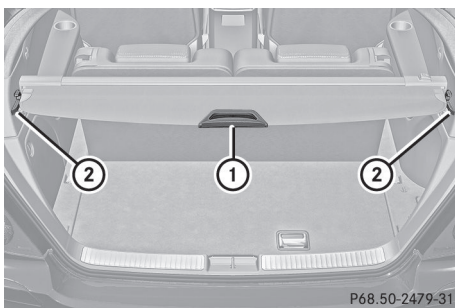

Cargo compartment cover installed behind the third row of seats

- ▶ **To extend:** pull the cargo compartment cover back by grab handle ① and clip it into retainers ② on the left and right.
- ▶ **To retract:** unhook the cargo compartment cover from retainers ② on the left and right and guide it forwards by grab handle ① until it is fully retracted.

Installing/removing the cargo compartment cover

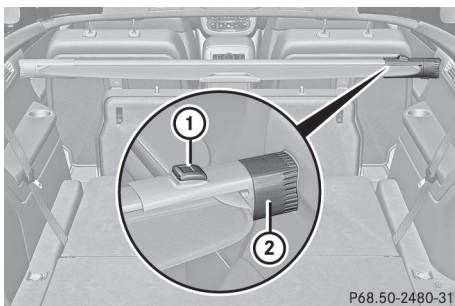

Cargo compartment cover installed behind the second row of seats

- ▶ **To remove:** make sure that cargo compartment cover ② is rolled up.
- ▶ Press button ①.
- ▶ Move cargo compartment cover ② to the left.
- ▶ Remove cargo compartment cover ②.

- ▶ **To install:** extend cargo compartment cover ② if you wish to install cargo compartment cover ② behind the second row of seats (▷ page 260).

! You must not install the extensions if you wish to install the cargo compartment cover behind the 3rd row of seats. The cargo compartment cover and side panels in the cargo compartment could otherwise be damaged.

- ▶ If installed, remove the protective caps from the side trims on the third row of seats when you wish to install cargo compartment cover ② behind the second row of seats.



Protective cap in the right-hand side trim on the third row of seats

- ▶ Push in the bottom of the protective cap as indicated by the arrow. The protective cap folds out at the top.
- ▶ Pull the top of the protective cap from the side trim in the direction of the arrow.
- i** Stow the protective caps in a safe place.
- ▶ With the handle of the cargo compartment pointing to the rear and button ① facing upwards, insert cargo compartment cover ② into the recess of the side trim on the left-hand side.
- ▶ Guide cargo compartment cover ② in front of the recess on the right.

- ▶ Press button ① and insert the right-hand side section into the recess of the side trim.
- ▶ Ensure that the cargo compartment cover has engaged properly.

Extending the cargo compartment cover

The cargo compartment cover is equipped with two extensions that are fastened securely to the cargo compartment cover with cords.

You must extend the cargo compartment cover if you wish to install the cargo compartment cover behind the 2nd row of seats.

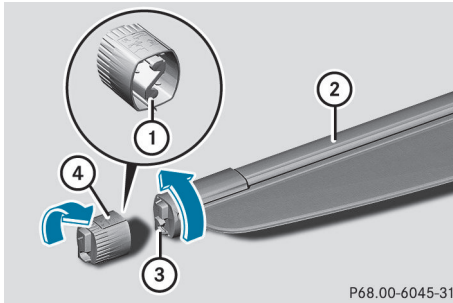

- ▶ Hold extension ④ in front of cargo compartment cover ② with guide pins ① pointing directly at guides ③.
- ▶ Turn extension ④ and cargo compartment cover ② towards each other in the direction of the arrow. Guide pins ① engage in guides ③.

If the extensions are not required, they can be secured to the cargo compartment cover.

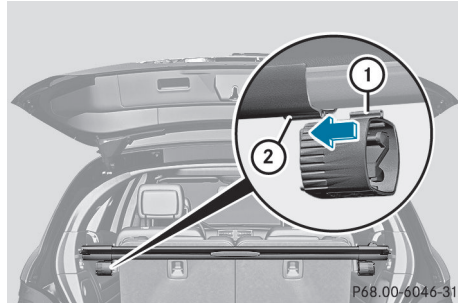

- ▶ Slide guide rail ① into guide ② to the stop.

Cargo net

Important safety notes

WARNING

Make sure the cargo net is properly engaged at top and bottom position and the tightening belts are securely fastened.

Never use a damaged cargo net.

Always use cargo net when transporting cargo. This helps to avoid personal injury from smaller objects being thrown around in the occupant compartment during a collision or sudden maneuver.

The cargo net cannot prevent the movement of large, heavier objects into the passenger compartment in an accident. Such items must be properly secured using the cargo tie-down rings in the cargo compartment floor.

Passenger use of seats behind installed cargo net is restricted because of the footwell being taken up by the net.

It is particularly important to use a safety net if the vehicle is loaded with small objects above the level of the backrests. For safety reasons, always use a cargo net when transporting loads.

Preparing the cargo net

The cargo net can be used in two different positions (behind the B-pillar or the C-pillar).

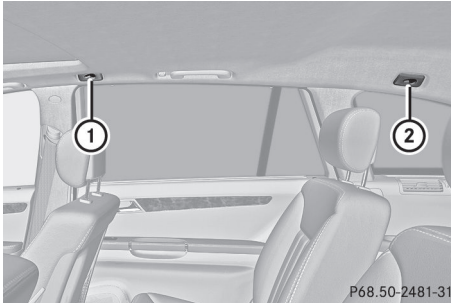

P68.50-2481-31

- The brackets behind B-pillar ① are required for the complete cargo compartment enlargement (▷ page 253). The corresponding cargo tie down rings to tighten the net are located in the footwell of the 2nd row of seats (▷ page 257).
 - The brackets behind C-pillar ② are required for the partial cargo compartment enlargement (▷ page 253). The corresponding cargo tie down rings to tighten the net are located in the footwell of the 3rd row of seats (▷ page 257).
- ▶ Undo the two Velcro fasteners of the safety-net stowage.
 - ▶ Unroll and unfold the cargo net. The upper and lower guide rods must engage audibly.

Attaching the cargo net

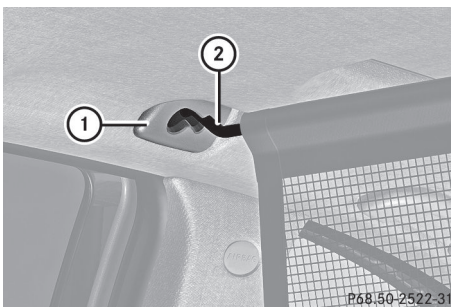

P68.50-2522-31

Cargo net attached behind the C-pillar

- ① Retainer
- ② Guide rod

- ▶ Insert guide rod ② into retainer ① in the direction of the arrow.
- ▶ Slide guide rod ② forwards into retainer ① in the direction of the arrow.

Tightening the cargo net

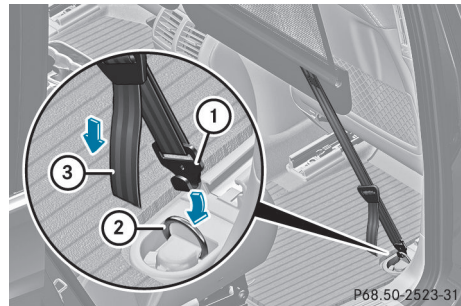

P68.50-2523-31

Seat belt reel holder behind the front seats

- ▶ Insert belt hook ① into cargo tie-down ring ② in the direction of the arrow.
- ▶ Pull tensioning strap ③ by the loose end in the direction of the arrow until the cargo net is tight.
- ▶ After driving a short distance, check the tension of the cargo net and retighten it if necessary.

Releasing the cargo net

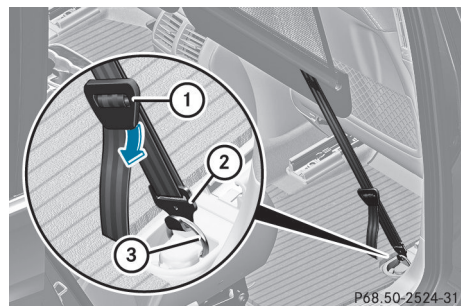

P68.50-2524-31

Seat belt reel holder behind the front seats

- ▶ Pull belt adjuster ① upwards in the direction of the arrow to reduce the tension on the tensioning strap.
- ▶ Unhook belt hook ② from cargo tie-down ring ③.

Detaching and storing the cargo net

- ▶ Detach guide rod ② from bracket ① (▷ page 261).
- ▶ Press the red button on the upper and lower guide rods.
- ▶ Fold the cargo net and roll it up.
- ▶ Close the two Velcro fasteners on the cargo net holder.

Roof carrier

Important safety notes

WARNING

Only use the roof rack when the basic carrier bars have been completely mounted. The left and right roof rails are only stabilized by means of the basic carrier bars being mounted.

Follow the manufacturer's installation instructions. Otherwise, an improperly attached roof rack system or its load could become detached from the vehicle.

Do not exceed the maximum roof load of 220 lb (100 kg).

Take into consideration that when the roof rack is loaded, the handling characteristics are different from those when operating the vehicle without the roof rack loaded.

- ❗ Mercedes-Benz recommends that you only use roof carriers that have been tested and approved for Mercedes-Benz vehicles. This helps to prevent damage to the vehicle.

Position the load on the roof carrier in such a way that the vehicle will not sustain damage even when it is in motion.

Depending on the vehicle equipment, ensure that when the roof carrier is installed you can:

- raise the sliding sunroof fully
- open the panorama roof with power tilt/sliding panel fully
- open the tailgate fully

Attaching the roof carrier

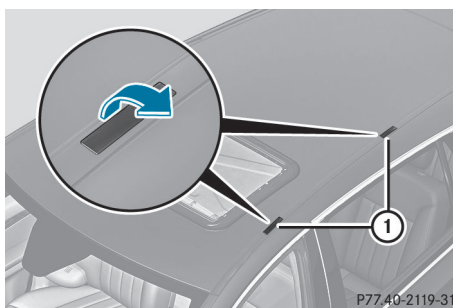

- ▶ Fold covers ① upwards.
- ▶ Only secure the roof carrier to the anchorage points under covers ①.
- ▶ Observe the manufacturer's installation instructions.

Features

Cup holders

Important safety notes

WARNING

In order to help prevent spilling liquids on vehicle occupants and/or vehicle equipment, only use containers that fit into the cup holder. Use lids on open containers and do not fill containers to a height where the contents, especially hot liquids, could spill during braking, vehicle maneuvers, or in an accident. Liquids spilled on vehicle occupants may cause serious personal injury. Liquids spilled on vehicle equipment may cause damage not covered by the Mercedes-Benz Limited Warranty.

When not in use, keep the cup holder closed. An open cup holder may cause injury to you or others when contacted during braking, vehicle maneuvers, or in an accident. Keep in mind that objects placed in the cup holder may come loose during braking, vehicle maneuvers, or in an accident and be thrown around in the vehicle interior. Objects thrown around in the vehicle interior may cause an accident and/or serious personal injury.

Cup holder in the front-compartment center console

In the front part of the center console, there is a cup holder and a removable support with a card holder.

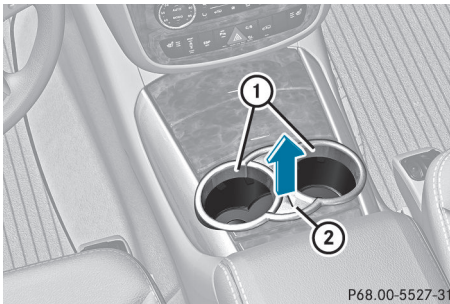

P68.00-5527-31

- **To remove the card holder:** raise card holder ② at the rear and remove.

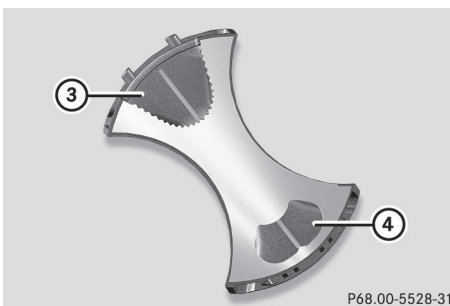

P68.00-5528-31

Cards and car park tickets can be inserted into the slot in the center.

The bottle opener is located under the card holder. It can be used to open both screw caps ③ and crown caps ④.

- ⓘ If you take out the card holder, you can remove the rubber insert for cleaning.

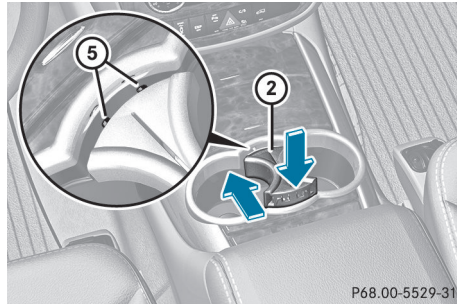

P68.00-5529-31

- **To install the card holder:** insert lugs ⑤ into the openings.
- Align card holder ② at the bottom and insert into cup holder ①.

Cup holder for the second row of seats below the center air vents

- ⚠ Close the cup holder if you are not using it and before folding down the second row of seats.

Short wheelbase vehicles with a cup holder in the second row of seats do not have an ashtray below the center air vents.

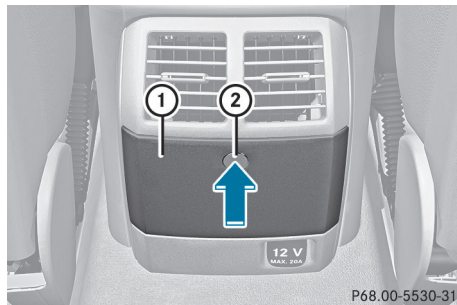

P68.00-5530-31

- **To open the cup holder:** press button ②. Cover ① opens automatically.

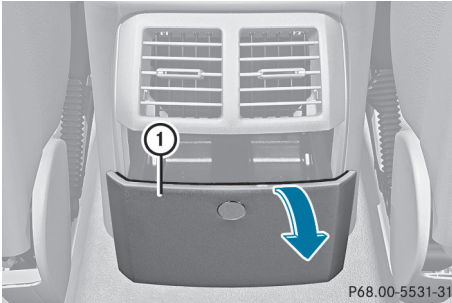

- ▶ Pull cover ① down in the direction of the arrow as far as it will go.

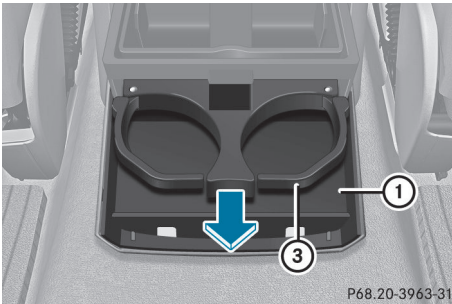

- ▶ Pull cup holder ③ out to the stop in the direction of the arrow.
- ▶ **To close the cup holder:** push cup holder ③ forwards into the stowage compartment until it engages.
- ▶ Fold cover ① upwards until it engages in the first position.
- ▶ Swing cover ① forwards until it engages in the second position.

Cup holder in front of the armrest of the second row of seats

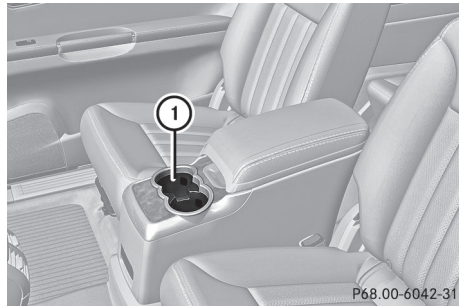

- ① Cup holders

Cup holder in the third row of seats

The cup holders are located in the side trim on the left and right-hand sides.

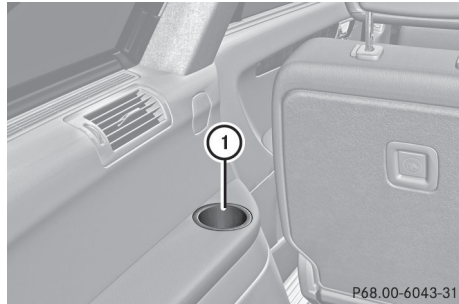

- ① Cup holders

Sun visors

Overview of sun visors

WARNING

Do not use the vanity mirror while driving. Keep the vanity mirrors in the sun visors closed while the vehicle is in motion. Reflected glare can endanger you and others.

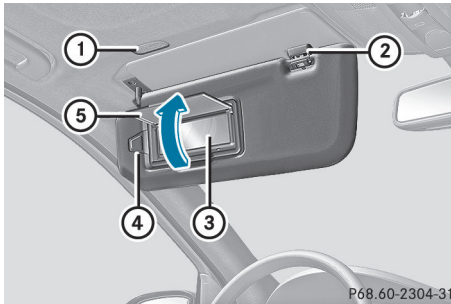

- ① Mirror light
- ② Bracket
- ③ Vanity mirror
- ④ Retaining clip, e.g. for a car park ticket
- ⑤ Mirror cover

Vanity mirror in the sun visor

Mirror light ① only functions if the sun visor is clipped into retainer ② and mirror cover ⑤ has been folded up.

Glare from the side

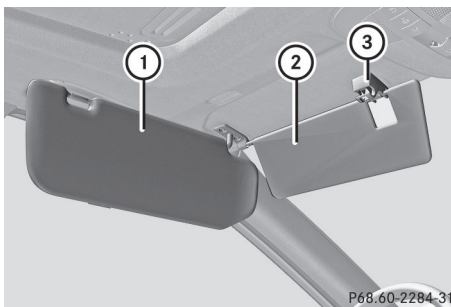

- ▶ Fold down sun visor ①.
- ▶ Pull sun visor ① out of retainer ③.
- ▶ Swing sun visor ① to the side.
- ▶ **Vehicles with a sliding sunroof:** fold down additional sun visor ② to the windshield.

Sunblinds on the rear side windows

The roller sunblinds for the rear side windows are only available in the USA.

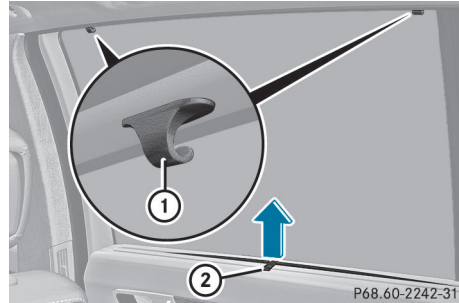

- ▶ **To extend:** pull the roller sunblind out by tab ② and hook it onto retainers ① at the top of the window.

⚠ Always guide the roller sunblind by hand. Do not let it snap back suddenly as this would damage the automatic roller mechanism.

⚠ Do not drive the vehicle with the roller sunblind hooked in and the side windows opened simultaneously. The roller sunblind can jump out of the retainers and spring back suddenly when driving at high speeds, e.g. when driving on the freeway. This could damage the inertia reel. Therefore, either close the side window or retract the roller sunblind before driving at high speeds.

Ashtray

Ashtray in the front-compartment center console

ℹ You can remove the ashtray insert and use the resulting compartment for stowage.

⚠ The stowage space under the ashtray is not heat resistant. Before placing lit cigarettes in the ashtray, make sure that the ashtray is properly engaged. Otherwise, the stowage space could be damaged.

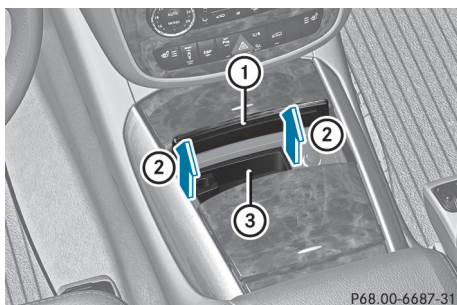

P68.00-6687-31

- ▶ **To open:** open cover ① (▷ page 249).
- ▶ **To remove the insert:** reach into the recess on the rear of insert ③.
- ▶ Lift insert ③ up ② and out.
- ▶ **To re-install the insert:** press insert ③ into the opening from above and press it down until it engages.

Ashtray in the second row of seats

Short wheelbase vehicles with a center console in the second row of seats do not have an ashtray below the center console.

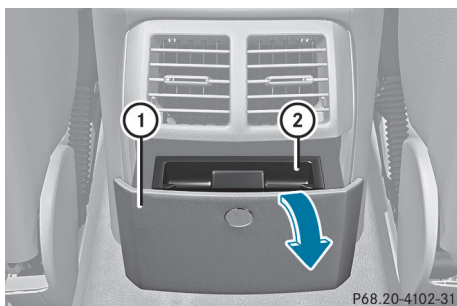

P68.20-4102-31

- ① Cover
- ② Insert

- ▶ **To open:** open cover ① (▷ page 250).
- ▶ Fold cover ① down in the direction of the arrow as far as it will go.

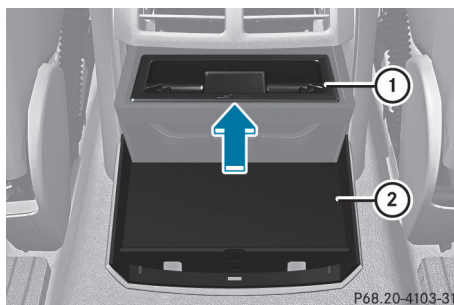

P68.20-4103-31

- ▶ **To remove the insert:** press insert ① in the direction of the arrow.
- ▶ Pull insert ① upwards and remove it.
- ▶ **To re-install the insert:** replace insert ① into the opening from above.
- ▶ Push insert ① down until it engages.
- ▶ **To close:** pull cover ② upwards until it engages in the first position.
- ▶ Swing cover ② forwards until it engages in the second position.

Cigarette lighter

⚠ WARNING

When leaving the vehicle, always remove the SmartKey from the ignition lock. Always take the SmartKey with you and lock the vehicle. Do not leave children unattended in the vehicle, even if they are secured in a child restraint system, or with access to an unlocked vehicle. A child's unsupervised access to a vehicle could result in an accident and/or serious personal injury. The children could:

- injure themselves on parts of the vehicle
- be seriously or fatally injured through excessive exposure to extreme heat or cold
- injure themselves or cause an accident with vehicle equipment that can be operated even if the SmartKey is removed from the ignition lock or removed from the vehicle, such as seat adjustment, steering wheel adjustment, or the memory function

If children open a door, they could injure other persons or get out of the vehicle and injure themselves or be injured by following traffic.

Do not expose the child restraint system to direct sunlight. The child restraint system's metal parts, for example, could become very hot, and the child could be burned on these parts.

WARNING

Never touch the heating element or sides of the lighter; they are extremely hot. Hold the knob only.

Make sure any children traveling with you do not injure themselves or start a fire with the hot cigarette lighter.

- !** The 12 V socket in the cigarette lighter can be used for accessories (up to a maximum of 85 W) as long as they have the standard socket type for cigarette lighters. Note that the socket in the cigarette lighter can be damaged when connecting accessories, for example by frequent insertion and removal or by sockets that do not fit correctly. A damaged socket can cause the cigarette lighter to stop working.

- !** The cigarette lighter in the center console in the front compartment is not intended for operating the tire inflation compressor.

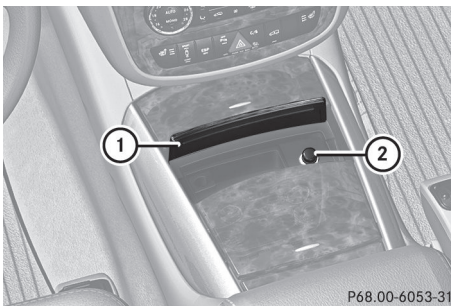

- ▶ Turn the SmartKey to position **2** in the ignition lock.
- ▶ **To open:** open cover ① (▷ page 249).
- ▶ Press in cigarette lighter ②.
Cigarette lighter ② will pop out automatically when the heating element is red-hot.

12 V sockets

Points to observe before use

- !** The socket in the center console and the socket in the cargo compartment are not intended for operating the tire inflation compressor.

The sockets can be used for accessories, e. g. lamps or mobile phone chargers with a maximum current draw of 240 W (20 A).

If you use the sockets for long periods when the engine is switched off, the battery may discharge.

- ▶ Turn the SmartKey to position **2** in the ignition lock.
- i** You can also use the power sockets when the SmartKey is in position **1** in the ignition lock.

An emergency cut-out ensures that the on-board voltage does not drop too low. If the on-board voltage is too low, the power to the sockets is automatically cut. This ensures that there is sufficient power to start the engine.

Socket in the front-passenger footwell

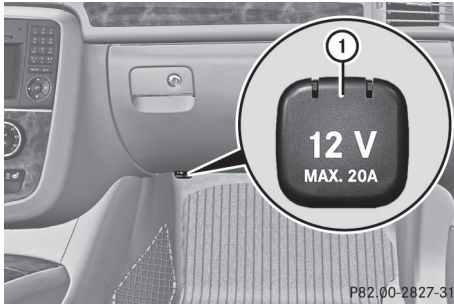

- ▶ Lift up the cover of socket ①.

Socket in the front-compartment center console

❗ If accessories are connected, make sure that a maximum current draw of 15 A is not exceeded. Otherwise, you will overload the fuse.

❗ The socket is not suitable for operating the tire inflation compressor.

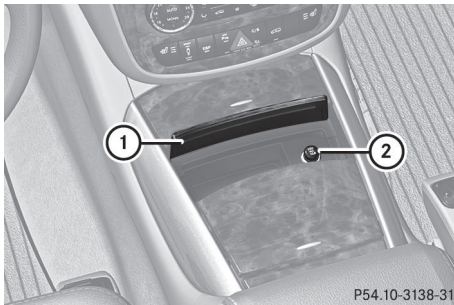

- ▶ **To open:** open cover ① (▷ page 249).
 - ▶ Remove cover ② from the socket.
- ❗ A cigarette lighter (▷ page 266) is installed in the center console instead of a socket in vehicles with an ashtray and a cigarette lighter.

Socket in the second row of seats

❗ If accessories are connected, make sure that a maximum current draw of 20 A is not

exceeded. Otherwise, you will overload the fuse.

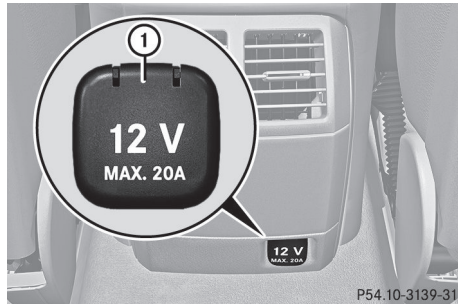

- ▶ Fold up the cover on socket ①.

Socket in the cargo compartment

❗ The socket is not suitable for operating the tire inflation compressor.

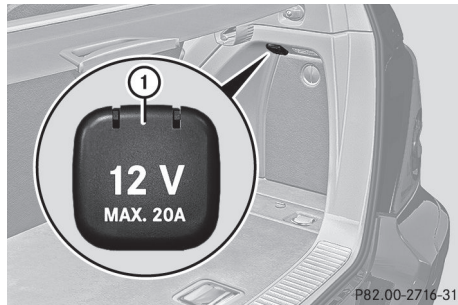

- ▶ Lift up the cover of socket ①.

115 V power socket

⚠ WARNING

The 115V AC socket operates at high voltage. Use the 115V AC socket in the vehicle with the same caution and prudence that you exercise when using power outlets at home. Keep any fluids away from the 115V AC socket. Do not clean the socket with fluids or tapered objects. Keep the 115V AC socket cover in the closed position, when not in use. Otherwise, you could suffer an electric shock and be seriously or even fatally injured.

WARNING

Any device that you connect must have a suitable plug and meet U.S. standards. Never pull at a cable to disconnect a plug from a 115 V AC power socket. Never use a damaged connection cable. The 115 V AC power socket must never be connected to another 115 V AC power source. Do not use a converter with an earthed plug for the 115 V AC power socket. This could cause serious injury to you and/or other people.

WARNING

If the 115V AC socket is damaged or torn out of the trim, do not use or touch the 115V AC socket. Using a 115V AC socket that is damaged or torn out of the trim could cause serious personal injury to you and/or others.

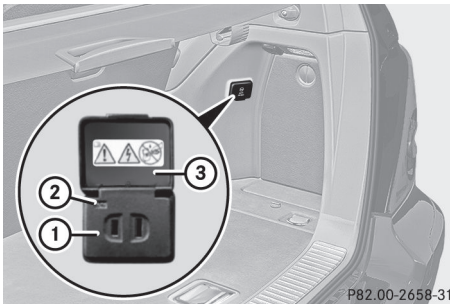

115 V socket ① provides an alternating voltage of 115 V, so that small electronic devices can be connected. These devices, such as games consoles, chargers and laptops, together should not consume more than a maximum of 150 W.

Requirements for operation of these devices:

- the plug of the electronic device must be inserted fully into 115 V power socket ①.
- the maximum wattage of the device to be connected must not exceed 150 W.
- the on-board power supply is within a permissible volt range.
- the 12 V sockets in the rear and the cargo compartment are operational (▷ page 267).

- ▶ Open flap ③.
- ▶ Insert the plug of the electronic device into 115 V power socket ①.
Indicator lamp ② lights up.
If indicator lamp ② does not light up, consult the section on malfunctions.
- ▶ **To turn off:** disconnect the plug from 115 V power socket ①.
Ensure that you do not pull on the cord.
- ▶ Close flap ③.



Possible causes of malfunction:

- the on-board power supply is not within a permissible volt range.
- the temperature of the DC/AC converter is temporarily too high.
- some small electronic devices have a constant nominal power of less than 150 W, but a very high inrush current. These devices will not work. If you connect such a device, 115 V power socket ① will not supply it with power.

If indicator lamp ② still does not light up, contact a specialist workshop, e.g. an authorized Mercedes-Benz Center.

mbrace

Important safety notes

 A license agreement must exist in order to activate the mbrace service. Ensure that your system is activated and ready for use, and press the  MB Info call button to register. If any of the steps mentioned is not carried out, the system may not be activated.

If you have questions about the activation, contact one of the following telephone assistance services:

- **USA:** Mercedes-Benz Customer Assistance Center under 1-888-990-9007
- **Canada:** Customer Service at 1-888-923-8367

Shortly after successfully registering with the mbrace service, a user ID and password will be sent to you by post. You can use this password to log in to the mbrace section under "Owners Online" at <http://www.mbusa.com>³¹.

The mbrace system is available if:

- it has been activated and is operational.
- the corresponding mobile phone network is available for transmitting data to the Customer Center.
- a service subscription is available.
- the starter battery is sufficiently charged.



i Determining the location of the vehicle on a map is only possible if there is sufficient GPS reception and the vehicle position can be forwarded to the Customer Center.

The mbrace system

The mbrace system provides different services, e.g.:

- automatic and manual emergency call
- Roadside Assistance call
- MB Info call

To adjust the volume during an mbrace call, proceed as follows:

▶ Press the  or  button on the multifunction steering wheel.

or

▶ Use the volume controller of COMAND.





You can find further information and a description of all available features under "Owners Online" at <http://www.mbusa.com>³².

System self-test

After you have switched on the ignition, the system carries out a self-diagnosis.

WARNING

A malfunction in the system has been detected if one of the following conditions occurs:

- the indicator lamp in the SOS button does not light up during the system self-diagnosis.
- the indicator lamp in the  Roadside Assistance button does not light up during the system self-diagnosis.
- The indicator lamp in the  information button does not light up during self-diagnosis of the system.
- the indicator lamp in the SOS button,  Roadside Assistance button or  information button continues to be lit red after the system self-diagnosis.
- The **Tele Aid Inoperative** or **Tele Aid Not Activated** message appears in the multifunction display after the system self-test.

If a malfunction is indicated as outlined above, the system may not operate as expected. In the event of an emergency, assistance must be summoned by other means.

Have the system checked at the nearest authorized Mercedes-Benz Center or contact the following service hotlines:

- **USA:** Response Center under 888-990-9007
- **Canada:** Customer Service at 1-888-923-8367

Emergency call

Important safety notes

i A license agreement must exist in order to activate the mbrace service. Ensure that your system is activated and ready for use, and press the  MB Info call button to register. If any of the steps mentioned is

³¹ USA only.

³² USA only.

not carried out, the system may not be activated.

If you have questions about the activation, contact one of the following telephone assistance services:

- **USA:** Mercedes-Benz Customer Assistance Center under 1-888-990-9007
- **Canada:** Customer Service at 1-888-923-8367

An emergency call is dialed automatically if an air bag or Emergency Tensioning Device is triggered.

- ❗ An mbrace emergency call that has been initiated automatically cannot be terminated by the customer.

An emergency call can also be initiated manually.

As soon as the emergency call has been initiated, the indicator lamp in the SOS button flashes. The **Connecting Call** message appears on the multifunction display. The audio output is muted.

The audio output is muted.

Once a connection has been established, the **Call Connected** message appears in the multifunction display.

All important information on the emergency is transmitted, for example:

- current location of the vehicle (as determined by the GPS system)
- vehicle identification number
- information on the type of emergency

Shortly after the emergency call has been initiated, a voice connection is automatically established between the Mercedes-Benz Customer Assistance Center and the vehicle occupants. If the vehicle occupants respond, the Mercedes-Benz Customer Assistance Center attempts to get more information on the emergency.

- ❗ If no vehicle occupant answers, an ambulance is immediately sent to the vehicle.

⚠ WARNING

If the indicator lamp in the SOS button is flashing continuously and no voice connection to the Mercedes-Benz Customer Assistance Center was established, then the mbrace system could not initiate an emergency call (e.g. the relevant cellular phone network is not available).

The message **Call Failed** appears in the multifunction display for approximately 10 seconds.

Should this occur, assistance must be summoned by other means.

Making an emergency call

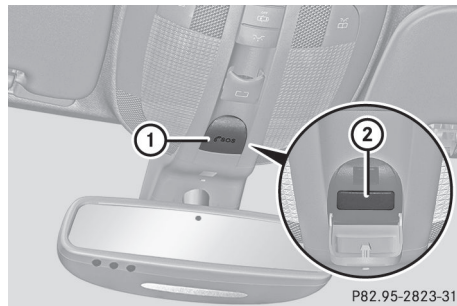

- ▶ **To initiate an emergency call manually:** press cover ① briefly to open it.
- ▶ Press SOS button ② briefly. The indicator lamp in SOS button ② flashes until the emergency call is concluded.
- ▶ Wait for a voice connection to the Mercedes-Benz Customer Assistance Center.
- ▶ After the emergency call is ended, close cover ①.

⚠ WARNING

If you feel in any way in jeopardy when in the vehicle (e.g. smoke or fire in the vehicle, vehicle in a dangerous road location), please do not wait for voice contact after you have pressed the SOS button. Carefully leave the vehicle and move to a safe location. The

Mercedes-Benz Customer Assistance Center will automatically contact local emergency officials with the vehicle's approximate location if they receive an automatic SOS signal and cannot make voice contact with the vehicle occupants.

Roadside Assistance button

- ▶ Open the stowage compartment under the armrest (▷ page 250).

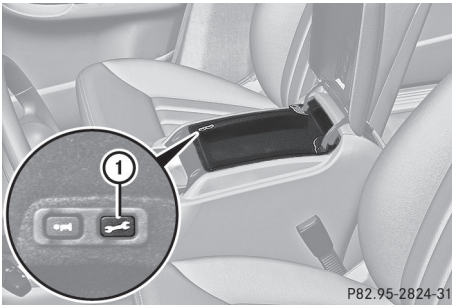

- ▶ Press and hold Roadside Assistance button ① for more than two seconds. This initiates a call to the Mercedes-Benz Customer Assistance Center. The indicator lamp in Roadside Assistance button ① flashes while the call is active. The **Connecting Call** message appears in the multifunction display. The audio output is muted.

If a connection can be established, the **Call Connected** message appears in the multifunction display.

If a cellular phone network is available and there is sufficient GPS reception, the mbrace system transmits data to the Mercedes-Benz Customer Assistance Center, for example:

- current location of the vehicle
- vehicle identification number

- ❗ The COMAND display shows that an mbrace call is active. During the call, you can change to the navigation menu by pressing the NAVI button on COMAND, for example.

Voice output is not available.

A voice connection is established between the Mercedes-Benz Customer Assistance Center and the vehicle occupants.

- ▶ Describe the type of assistance needed.

The Mercedes-Benz Customer Assistance Center either sends a qualified Mercedes-Benz technician or organizes for your vehicle to be transported to the nearest authorized Mercedes-Benz Center. You may be charged for services such as repair work and/or towing. Further details are available in your mbrace manual.

- ❗ The mbrace system failed to initiate a Roadside Assistance call if:

- the indicator lamp in Roadside Assistance button ① is flashing continuously.
- no voice connection to the Mercedes-Benz Customer Assistance Center was established.

This may be because the corresponding mobile phone network is not available.

The **Call Failed** message appears in the multifunction display.

- ▶ **To end a call:** press the  button on the multifunction steering wheel.

or

- ▶ Press the corresponding button for ending a phone call on COMAND.

MB Info call button

- ▶ Open the stowage compartment under the armrest (▷ page 250).

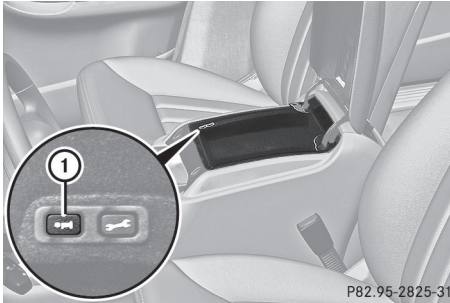

- ▶ Press and hold MB Info call button ① for more than two seconds. This initiates a call to the Mercedes-Benz Customer Assistance Center. The indicator lamp in MB Info call button ① flashes while the connection is being established. The **Connecting Call** message appears in the multifunction display. The audio output is muted.

If a connection can be established, the **Call Connected** message appears in the multifunction display.

If a cellular phone network is available and there is sufficient GPS reception, the mbrace system transmits data to the Mercedes-Benz Customer Assistance Center, for example:

- current location of the vehicle
- vehicle identification number

- ❗ The COMAND display shows that an mbrace call is active. During the call, you can change to the navigation menu by pressing the NAVI button on COMAND, for example.

Voice output is not available.

A voice connection is established between the Mercedes-Benz Customer Assistance Center and the vehicle occupants. You can obtain information on how to operate your vehicle's systems, on the location of the nearest authorized Mercedes-Benz Center, and on further products and services offered by Mercedes-Benz USA.

Further details on the mbrace system can be found under <http://www.mbusa.com>³³. Log in under "Owners Online".

- ❗ The mbrace system failed to initiate an MB Info call if:

- the indicator lamp in MB Info call button ① is flashing continuously.
- no voice connection to the Mercedes-Benz Customer Assistance Center was established.

This may be because the corresponding mobile phone network is not available.

The **Call Failed** message appears in the multifunction display.

- ▶ **To end a call:** press the  button on the multifunction steering wheel.

or

- ▶ Press the corresponding button for ending a phone call on COMAND.

Call priority

When service calls are active, e.g. Roadside Assistance or MB Info calls, an emergency call can still be initiated. In this case, an emergency call will take priority and override all other active calls.

The indicator lamp of the respective button flashes until the call is ended. An emergency call can only be terminated by the Mercedes-Benz Customer Assistance Center. All other calls can be ended by pressing the  button on the multifunction steering wheel or the corresponding button for ending a telephone call on COMAND.

Downloading destinations in COMAND

- ❗ Information on the components and operating principles of COMAND can be found in the separate COMAND operating instructions.

³³ USA only.

- i** You can only use the Destination Download function if the vehicle is equipped with a navigation system.

Destination Download gives you access to a database with over 15 million points of interest (POIs)/important destinations that can be downloaded onto the navigation system of your vehicle. If you know the destination, you can download the address or obtain the location of points of interest (POIs)/important destinations in the surrounding area.

You are prompted to confirm route guidance to the address entered.

- ▶ Select **Yes** with the ◀ or ▶ buttons on COMAND.
- ▶ Press the **OK** button on COMAND to confirm.

The system calculates the route and subsequently starts the route guidance with the address entered.

- i** If you select **No**, the address can be stored in the address book.
- i** The Destination Download function is available if the corresponding mobile phone network is available and data transfer is possible.

Route Assistance

This service is part of the mbrace PLUS Package and cannot be purchased separately.

- i** You can also use the Route Assistance function if your vehicle is not equipped with a navigation system.

Within the framework of this service, you receive a professional and reliable form of navigation support without having to leave your vehicle.

The customer service representative determines a suitable driving route based on your current vehicle position and the desired

destination and guides you live through the current sections of the route.

Search & Send

"Search & Send" is a destination entry service. You can find further information on "Search & Send" in the separate COMAND operating instructions.

Vehicle remote opening

If you have unintentionally locked your vehicle (e.g. the SmartKey is still in the vehicle) and a replacement SmartKey is not available, the vehicle can be opened by a Mercedes-Benz Customer Assistance Center. The vehicle can be opened remotely up to four days after the ignition was last switched off.

- ▶ Contact the following service hotlines:
 - **USA:** Mercedes-Benz Customer Assistance Center under 1-800-FOR-MERCEdes(1-800-367-6372) or 1-888-990-9007
 - **Canada:** Customer Service at 1-888-923-8367
 You will be asked for your password.
- ▶ Return to your vehicle at the time agreed upon with the Mercedes-Benz Customer Assistance Center.
- ▶ Pull the tailgate handle for at least 20 seconds until the indicator lamp in the SOS button (▷ page 270) flashes. The **Connecting Call** message appears on the multifunction display.

Alternatively, the vehicle can also be opened via the Internet or an iPhone in the "Owners Online" section using your ID number and password³⁴.

- i** Vehicle remote unlocking is only possible if the corresponding mobile phone network is accessible. The SOS button flashes and the **Call Connected** message appears in the multifunction display to confirm that the

³⁴ USA only.

command for vehicle remote unlocking has been received.

If you pull the tailgate handle for more than 20 seconds before receiving authorization for remote unlocking from the Mercedes-Benz Customer Assistance Center, you must wait 15 minutes before you can pull the tailgate handle again.

Service for recovering a stolen vehicle

If your vehicle has been stolen:

- ▶ Notify the police.
The police will issue a numbered incident report.
 - ▶ This number will be forwarded to the Mercedes-Benz Customer Assistance Center together with your PIN.
The Mercedes-Benz Customer Assistance Center then attempts to locate the mbrace system. The Mercedes-Benz Customer Assistance Center contacts you and the local law enforcement agency if the vehicle is located. However, only the law enforcement agency is informed of the location of the vehicle.
- i** If the anti-theft alarm system is active for longer than 30 seconds, mbrace automatically informs the Mercedes-Benz Customer Assistance Center.

Garage door opener

Important safety notes

The HomeLink® garage door opener integrated in the rear-view mirror allows you to operate up to three different door and gate systems.

- i** Certain garage door drives are incompatible with the integrated garage door opener. If you have difficulty programming the integrated garage door opener, contact an authorized Mercedes-Benz Center or call one of the following telephone hotlines:

- **USA:** Mercedes-Benz Customer Assistance Center at 1-800-FOR-MERcedes
- **Canada:** Customer Service at 1-800-387-0100

WARNING

Before programming the integrated remote control to a garage door opener or gate operator, make sure people and objects are out of the way of the device to prevent potential harm or damage. When programming a garage door opener, the door moves up or down. When programming a gate operator, the gate opens or closes.

Do not use the integrated remote control with any garage door opener that lacks safety stop and reverse features as required by U.S. federal safety standards (this includes any garage door opener model manufactured before April 1, 1982). A garage door that cannot detect an object - signaling the door to stop and reverse - does not meet current U.S. federal safety standards.

When programming a garage door opener, park vehicle outside the garage.

Do not run the engine while programming the integrated remote control. Inhalation of exhaust gas is hazardous to your health. All exhaust gas contains carbon monoxide (CO), and inhaling it can cause unconsciousness and possible death. All exhaust gas contains carbon monoxide (CO), and inhaling it can cause unconsciousness and possible death.

- i** USA only:
This device complies with Part 15 of the FCC requirements. Operation is subject to the following two conditions:

1. This device must not cause harmful interference, and
2. this device must withstand any interference received, including interference that may cause undesired operation.

Any unauthorized modification to this device could void the user's authority to operate the equipment.

i Canada only:

This device complies with RSS-210 of Industry Canada. Operation is subject to the following two conditions:

1. This device must not cause harmful interference, and
2. this device must withstand any interference received, including interference that may cause undesired operation.

Any unauthorized modification to this device could void the user's authority to operate the equipment.

Programming the integrated garage door opener on the rear-view mirror

Programming

⚠ WARNING

Only press the transmitter button on the integrated garage door opener if there are no persons or objects present within the sweep of the garage door. People could otherwise be injured by the movement of the door.

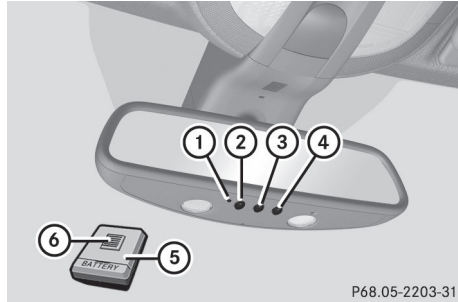

Integrated garage door opener on the rear-view mirror

Garage door remote control **⑤** is not part of this integrated garage door opener.

- i** To achieve the best result, insert new batteries in garage door remote control **⑤** before programming.
- ▶ Before programming for the first time, clear the memory of the integrated garage door opener (▷ page 278).
 - ▶ Turn the SmartKey to position **2** in the ignition lock.
 - ▶ Press and hold one of transmitter buttons **②** to **④** on the integrated garage door opener. Indicator lamp **①** starts to flash yellow after a short period.
 - i** Indicator lamp **①** flashes yellow immediately after the transmitter button has been stored for the first time. If the transmitter button has already been programmed, indicator lamp **①** does not flash yellow until 10 seconds have elapsed.
 - ▶ Release the transmitter button.
 - ▶ Point transmitter button **⑥** of garage door remote control **⑤** towards the transmitter buttons on the rear-view mirror at a distance of 2 to 8 inches (5 to 20 cm).
 - i** The distance required between garage door remote control **⑤** and the integrated garage door opener depends on the system of the garage door drive. You might require several attempts. You should test every

position for at least 25 seconds before trying another position.

- ▶ Press and hold transmitter button ⑥ on garage door remote control ⑤ until indicator lamp ① lights up green. Programming is complete if indicator lamp ① lights up or flashes green.
- ▶ Release transmitter button ②, ③ or ④ on the integrated garage door opener and the transmitter button on garage door remote control ⑥.

If indicator lamp ① lights up red:

- ▶ Repeat the programming procedure for the transmitter button. When doing so, vary the distance between the garage door remote control and the rear-view mirror.
- i** If the indicator lamp flashes green after successful programming, the garage door system is operating on a rolling code. After programming, you must synchronize the garage door opener integrated in the rear-view mirror with the receiver of the garage door system.

Synchronizing the rolling code

Your vehicle must be within range of the garage or gate opener drive. Make sure that neither your vehicle nor any persons/objects are present within the sweep of the door or gate.

Observe the safety notes when performing the rolling code synchronization.

- ▶ Turn the SmartKey to position **2** in the ignition lock.
 - ▶ Press the programming button of the door or gate drive (see the door or gate drive operating instructions, e.g. under "Programming of additional remote controls").
- i** You now normally have 30 seconds to initiate the next step.
- ▶ Press the previously programmed transmitter button of the HomeLink®

integrated garage door opener repeatedly in succession until the door opens. The rolling code synchronization is then complete.

Notes on programming the remote control

Canadian radio frequency laws require a "break" (or interruption) of the transmission signals after broadcasting for a few seconds. These signals may not therefore last long enough for the integrated garage door opener to recognize the signal during programming. Comparable with Canadian law, some U.S. garage door openers also have a built-in "interruption".

If you live in Canada or have difficulties programming the garage door opener (regardless of where you live) when using the programming steps (see above), proceed as follows:

- ▶ Press and hold one of transmitter buttons ② to ④ of the integrated garage door opener. Indicator lamp ① starts to flash yellow after a short period.
- ▶ Release the transmitter button.
- ▶ Press transmitter button ⑥ of the garage door remote control and hold for two seconds, then release for two seconds, then press again and hold for two seconds.
- ▶ Repeat this sequence on transmitter button ⑥ of the garage door remote control until indicator lamp ① is green. Repeat the process if indicator lamp ① turns red.
- ▶ Continue with the other programming steps (see above).

Problems when programming

If you are experiencing problems programming the integrated garage door opener on the rear-view mirror, take note of the following instructions:

- check the transmission frequency of garage door remote control ⑤ (usually

found on the reverse side of the remote control).

The integrated garage door opener is compatible with devices that can be operated with units in a frequency range of 280 to 390 MHz.

- change the batteries in garage door remote control ⑤. This increases the probability that garage door remote control ⑤ will send a strong and precise signal to the integrated garage door opener on the rear-view mirror.
- when programming, hold garage door remote control ⑤ at different distances and angles from the transmitter button that you are programming. Try different angles at a distance between 2 and 12 inches (5 to 30 cm) or the same angle at varying distances.
- if another remote control for the same garage door drive is available, repeat the same programming steps with this remote control. Before you perform the steps of the operation, make sure that there are new batteries in the garage door remote control.
- note that some remote controls only transmit for a limited amount of time (the indicator lamp on the remote control goes out). Press the remote control button again before it stops transmitting.
- align the antenna cable of the garage door opener unit. This can improve signal reception/transmission.

Opening/closing the garage door

Once programmed, the integrated garage door opener will assume the function of the garage door system's remote control. Please also read the operating instructions for the garage door system.



- ▶ Turn the SmartKey to position **2** in the ignition lock.
 - ▶ Press transmitter button ②, ③ or ④ in the overhead control panel that you have programmed to operate the garage door.
 - Garage door system with a fixed code: indicator lamp ① lights up green.
 - Garage door system with a rolling code: indicator lamp ① flashes green.
- i** The transmitter will transmit a signal for as long as the transmitter button is being pressed. After a maximum of ten seconds, transmission is terminated and indicator lamp ① flashes yellow. Press the transmitter button again, if necessary.

Clearing the memory of the integrated garage door opener on the rear-view mirror

- ▶ Turn the SmartKey to position **2** in the ignition lock.
 - ▶ Press transmitter buttons ② and ④. The indicator lamp lights up yellow.
 - ▶ Press and hold transmitter buttons ② and ④ until the indicator lamp turns green.
- i** Make sure that you clear the memory of the integrated garage door opener before selling the vehicle.

Compass

Calling up the compass

- ▶ Press the  or  button on the multifunction steering wheel repeatedly until the **AIRMATIC/Compass** menu appears in the multifunction display. The compass shows which direction the vehicle is currently traveling in: **N, NE, E, SE, S, SW, W** or **NW**.

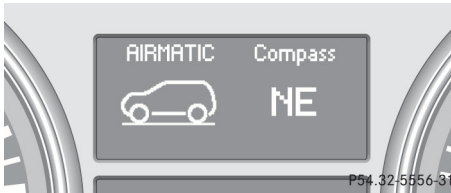

- i** If your vehicle does not have an AIRMATIC package, the multifunction display only shows the compass.

Floormat on the driver's side

WARNING

Whenever you are using a floormat, make sure there is enough clearance and that the floormat is securely fastened.

The floormat should always be securely fastened using the fastening equipment.

Before driving off, check that the floormat is securely in place and adjust it if necessary. A loose floormat could slip and hinder proper functioning of the pedals.

Do not place several floormats on top of each other as this may impair pedal movement.

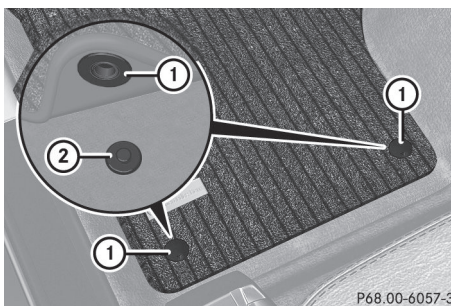

- ▶ Slide the seat backwards.
- ▶ **To install:** place the floormat in the footwell.
- ▶ Press studs ① onto retainers ②.
- ▶ **To remove:** pull the floormat off retainers ②.
- ▶ Remove the floormat.

Infrared reflective windshield

The infrared reflecting glass prevents the vehicle interior from becoming too hot. It also blocks radio waves up into the gigahertz range.

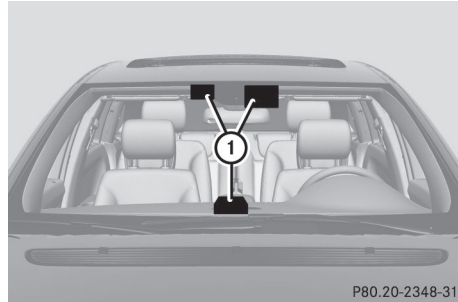

In order to operate radio-controlled equipment, e.g. toll recording systems, areas ① on the windshield are permeable to radio waves. In these areas, you can install radio-controlled systems.

These areas can best be seen from outside the vehicle by observing the light reflected off the windshield.

Useful information	282
Engine compartment	282
Maintenance	287
Care	287

Useful information

- i** This Operator's Manual describes all models and all standard and optional equipment of your vehicle available at the time of publication of the Operator's Manual. Country-specific differences are possible. Please note that your vehicle may not be equipped with all features described. This also applies to safety-related systems and functions.
- i** Please read the information on qualified specialist workshops (▷ page 24).

Engine compartment

Hood

Opening the hood

 **WARNING**

Do not pull the release lever while the vehicle is in motion. Otherwise, the hood could be forced open by passing air flow.

This could cause the hood to come loose and injure you and/or others.

 **WARNING**

Do not open the hood when the engine is overheated. You could be seriously injured. Observe the coolant temperature display to determine whether the engine may be overheated. If you see flames or smoke coming from the engine compartment, move away from the vehicle. Wait until the engine has cooled. If necessary, call the fire department.

 **WARNING**

There is a risk of injury if the hood is open, even if the engine is not running.

Some engine components can become very hot.

To avoid the risk of burns, only touch those components described in the Operator's Manual and observe the relevant safety notes.

 **WARNING**

To help prevent personal injury, stay clear of moving parts when the hood is open and the engine is running.

The radiator fan may continue to run for approximately 30 seconds or may even restart after the engine has been turned off. Stay clear of fan blades.

 **WARNING**

Vehicles with gasoline engine:

The engine is equipped with a transistorized ignition system. Because of the high voltage it is dangerous to touch any components (ignition coils, spark plug sockets, diagnostic socket) of the ignition system

- with the engine running
- while starting the engine
- when the ignition is switched on and the engine is turned manually

 **WARNING**

Vehicles with diesel engine:

The engine is equipped with a high-voltage electronic control unit for the injection system. Because of the high voltage it is dangerous to touch any components of the injection system (injectors, electrical wires)

- with the engine running
- while starting the engine
- when the ignition is switched on

- ▶ Make sure that the windshield wipers are switched off.

 **WARNING**

The windshield wipers and wiper linkage could be set in motion.

When the hood is open, you or others could be injured by the wiper linkage.

Make sure that the windshield wipers are switched off. Remove the SmartKey or make sure that no ignition position has been selected with KEYLESS-GO. All indicator lamps must be off in the instrument cluster.



- ▶ Pull release lever ① on the hood. The hood is released.

! Make sure that the windshield wipers are not folded away from the windshield. You could otherwise damage the windshield wipers or the hood.

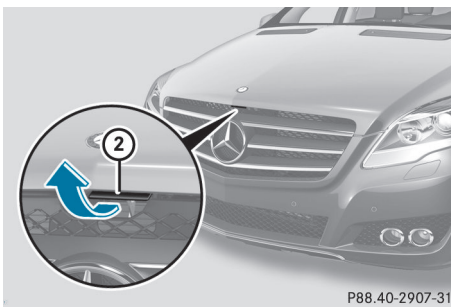

- ▶ Reach into the gap, pull hood catch handle ② up and lift the hood. Once you have lifted the hood about 15 inches (40 cm), it is automatically opened the rest of the way and held open by the gas-filled struts.

Closing the hood

⚠ WARNING

When closing the hood, use extreme caution not to catch hands or fingers. Be careful that you do not close the hood on anyone.

Make sure the hood is securely engaged before driving off. Do not continue driving if the hood can no longer engage after an accident, for example. The hood could

otherwise come loose while the vehicle is in motion and injure you and/or others.

- ▶ Lower the hood and let it fall from a height of approximately 8 inches (20 cm).
- ▶ Check that the hood has engaged properly. If the hood can be raised slightly, it is not properly engaged. Open it again and close it with a little more force.

Radiator

- i Vehicles with a diesel engine:** do not cover the radiator, for example with a winter front or bug cover. Otherwise, the readings of the on-board-diagnostic system may be inaccurate. Some of these readings are required by law and must be accurate at all times.

Engine oil

Notes on the oil level

Depending on the driving style, the vehicle consumes up to 0.9 US qts. (0.8 l) of oil over a distance of 600 miles (1000 km). The oil consumption may be higher than this when the vehicle is new or if you frequently drive at high engine speeds.

Checking the oil level using the oil dipstick

When checking the oil level:

- park the vehicle on a level surface.
- the engine should be switched off for approximately five minutes if the engine is at normal operating temperature.

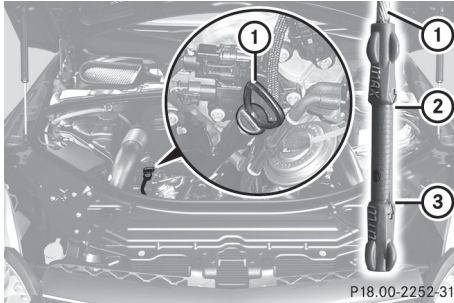

Example: gasoline engine

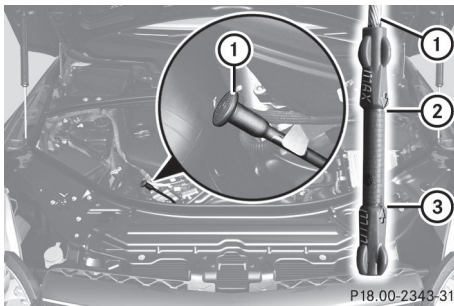

Example: diesel engine

- ▶ Pull oil dipstick ① out of the dipstick guide tube.
- ▶ Wipe off oil dipstick ①.
- ▶ Slowly slide oil dipstick ① into the guide tube to the stop, and take it out again. The oil level is correct if the level is between MIN mark ③ and MAX mark ②.
- ▶ Add oil if necessary.

Adding engine oil

Environmental note

When adding oil, take care not to spill any. If oil enters the soil or waterways, it is harmful to the environment.

WARNING

If engine oil comes into contact with hot engine parts, it may ignite and you could burn yourself. Do not spill any engine oil on hot engine parts.

- ❗ Use only engine oils and oil filters that have been approved for vehicles equipped with a service system. A list of the engine oils and oil filters tested and approved in accordance with the Mercedes-Benz Specifications for Service Products can be called up by visiting <http://www.mbusa.com> (USA only). More information about tested and approved engine oils and oil filters is available from any authorized Mercedes-Benz Center. Damage to the engine or exhaust system is caused by the following:

- using engine oils and oil filters which have not been specifically approved for the service system.
- replacing the engine oil or oil filter after the replacement interval required by the service system has elapsed
- using engine oil additives.



Example: engine oil cap

- ▶ Turn cap ① counter-clockwise and remove it.
- ▶ Add the amount of oil required.

Fill carefully to the maximum mark on the oil dipstick.

- ℹ Depending on the engine, the difference in quantity between the MIN mark and the MAX mark on the dipstick is approximately 1.6 to 2.1 US qt (1.5 to 2 l).

- ❗ Do not add too much oil. If the oil level is above the "max" mark on the dipstick, too much oil has been added. This can lead to

damage to the engine or the catalytic converter. Have excess oil siphoned off.

For further information on engine oil, see (▷ page 358).

- ▶ Replace cap ① on the filler neck and tighten clockwise. Ensure that the cap locks into place securely.

Checking and adding other service products

Checking the coolant level

Only check the coolant level when the vehicle is on a level surface and the engine has cooled down.

- ▶ Turn the SmartKey to position 2 (▷ page 145) in the ignition lock. On vehicles with KEYLESS-GO, press the Start/Stop button twice (▷ page 145).
- ▶ Check the coolant temperature gauge in the multifunction display. The coolant temperature must be below 158 °F (70 °C).

WARNING

In order to avoid any potentially serious burns:

- use extreme caution when opening the hood if there are any signs of steam or coolant leaking from the cooling system, or if the coolant temperature display indicates that the coolant is overheated.
- do not remove the pressure cap on the coolant reservoir if the coolant temperature is above 158 °F (70 °C). Allow the engine to cool down before removing the cap. The coolant reservoir contains hot fluid and is under pressure.
- using a rag, slowly turn the cap approximately 1/2 turn to relieve excess pressure. If opened immediately, scalding

hot fluid and steam will be blown out under pressure.

- do not spill antifreeze on hot engine parts. Antifreeze contains ethylene glycol which may burn if it comes into contact with hot engine parts.

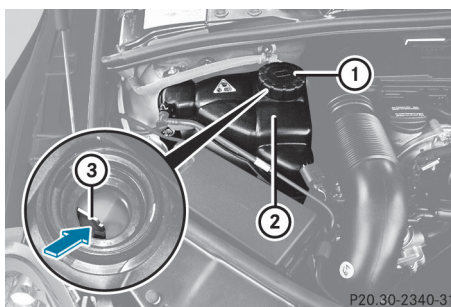

- ▶ Slowly turn cap ① half a turn counter-clockwise and allow excess pressure to escape.
- ▶ Turn cap ① further counter-clockwise and remove it. If the coolant is at the level of marker bar ③ in the filler neck when cold, there is enough coolant in coolant expansion tank ②.

If the coolant is approximately 0.6 in (1.5 cm) above marker bar ③ in the filler neck when warm, there is enough coolant in coolant expansion tank ②.

- ▶ If necessary, add coolant that has been tested and approved by Mercedes-Benz.
- ▶ Replace cap ① and turn it clockwise as far as it will go.

For further information on coolant, see (▷ page 359).

Windshield washer system and headlamp cleaning system

The washer fluid reservoir is used for both the windshield washer system and the headlamp cleaning system.

-  Vehicle components and their service products must match. You should,

therefore, only use products that have been tested and approved by Mercedes-Benz.

Information on tested and approved products can be obtained at any authorized Mercedes-Benz Center or on the Internet at <http://www.mbusa.com> (USA only).

WARNING

Washer solvent/antifreeze is highly flammable. Do not spill washer solvent/antifreeze on hot engine parts, because it may ignite and burn. You could be seriously burned.

! At temperatures below freezing: always fill the washer fluid reservoir with a mix of water and windshield washer concentrate (e.g. MB WinterFit). There is otherwise a risk of damaging the windshield washer system/headlamp cleaning system.

! Only use washer fluid concentrate which is suitable for plastic lenses. Unsuitable washer fluid concentrate could damage the plastic lenses of the headlamps.

! Do not add distilled or de-ionized water to the washer fluid container. Otherwise, the level sensor may be damaged.

i Add windshield washer concentrate, e.g. MB SummerFit, to the washer fluid all year round.

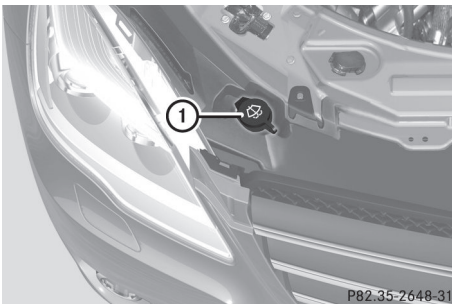

Example: washer fluid reservoir

- ▶ Mix the windshield washer fluid in a container beforehand.
- ▶ **At temperatures above freezing:** fill the washer fluid reservoir with a mix of water

and windshield washer concentrate (e.g. MB SummerFit).

- ▶ **At temperatures below freezing:** fill the washer fluid reservoir with a mix of water and windshield washer concentrate (e.g. MB WinterFit). Adapt the mixing ratio to the outside temperature. For information on the mixing ratio (▶ page 360).
- ▶ **To open:** pull cap ① upwards by the tab.
- ▶ Add the premixed washer fluid.
- ▶ **To close:** press cap ① onto the filler neck until it engages.

Brake fluid level

! If you notice that the brake fluid level in the brake fluid reservoir has fallen to the MIN mark or less, check the brake system immediately for leaks. Also check the thickness of the brake linings. Contact a qualified specialist workshop, e.g. an authorized Mercedes-Benz Center immediately.

Do not add brake fluid. This does not correct the error.

Only check the brake fluid level when the vehicle is stationary and on a level surface.

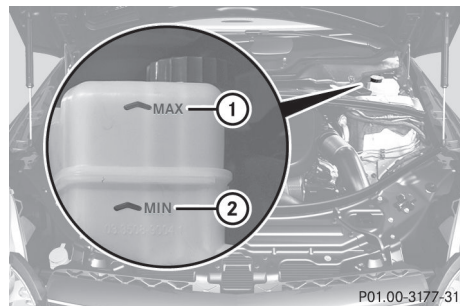

The brake fluid level is correct if it is between MIN marking ② and MAX marking ① on the brake fluid reservoir.

Maintenance

Service interval display

Service messages

Information on the type of service and service intervals (see separate Service Booklet).

You can obtain further information from an authorized Mercedes-Benz Center or at <http://www.mbusa.com> (USA only).

The service interval display informs you of the next service due date.

If a service due date has been exceeded, you also hear an acoustic signal.

The multifunction display shows a service message for a few seconds, e.g.

Service A in .. mi

Service A due now

Service A overdue by .. mi

The letter indicates how much time the workshop will require to carry out the service work. The letters displayed range from **A** for a short service duration to **H** for a long service duration.

The service interval display does not take into account any periods of time during which the battery is disconnected.

Maintaining the time-dependent service schedule:

- ▶ Note down the service due date displayed in the multifunction display before disconnecting the battery.

or





- ▶ Subtract the battery disconnection periods from the service date shown on the display after reconnecting the battery.

i The service interval display does not provide any information regarding the engine's oil level. Observe the notes on the engine oil level (▷ page 283).

Hiding a service message

- ▶ Press the **R** reset button on the instrument cluster (▷ page 29).

Displaying a service message

- ▶ Switch on the ignition.
- ▶ Press  or  to select the **standard display** menu on the steering wheel (▷ page 202).
- ▶ Select  or  to select the service interval display.
The service due date appears in the multifunction display.

Please bear the following in mind

Resetting service interval display

If the qualified specialist workshop, e.g. a Mercedes-Benz Center, carried out the maintenance work, the service interval display will be reset.

Further information, on maintenance for example, can be obtained at an authorized Mercedes-Benz Center or directly from Mercedes-Benz.

! If the service interval display has been reset unintentionally, have the setting corrected at a Mercedes-Benz Center.

Have service work carried out as described in the Service Booklet. This may otherwise lead to increased wear and damage to the major assemblies or the vehicle.

Driving abroad

An extensive Mercedes-Benz Service network is also available in other countries. You can obtain further information from any authorized Mercedes-Benz Center.

Care

Notes on care

Regular care of your vehicle is a condition for retaining the quality in the long term.

Use care products and cleaning agents recommended and approved by Mercedes-Benz.

WARNING

Many cleaning products can be hazardous. Some are poisonous, others are flammable. Always follow the instructions on the particular container. Always open your vehicle's doors or windows when cleaning the inside.

Never use fluids or solvents that are not designed for cleaning your vehicle.

Always lock away cleaning products and keep them out of reach of children.

! For cleaning your vehicle, do not use any of the following:

- dry, rough or hard cloths
- abrasive cleaning agents
- solvents
- cleaning agents containing solvents

Do not scrub.

Do not touch the surfaces or protective films with hard objects, e.g. a ring or ice scraper. You could otherwise scratch or damage the surfaces and protective film.

Environmental note

Dispose of empty packaging and cleaning cloths in an environmentally responsible manner.

! Do not park the vehicle for an extended period straight after cleaning it, particularly after having cleaned the wheels with wheel cleaner. Wheel cleaners could cause increased corrosion of the brake discs and brake pads/linings. For this reason, you should drive for a few minutes after cleaning. Braking heats the brake discs and the brake pads/linings, thus drying them. The vehicle can then be parked.

Exterior care

Automatic car wash

WARNING

Braking efficiency is reduced after washing the vehicle. This could cause an accident. For this reason, you must drive particularly carefully after washing the vehicle until the brakes have dried.

You can wash the vehicle in an automatic car wash from the very start.

! Never clean your vehicle in a Touchless Automatic Car Wash as these use special cleaning agents. These cleaning agents can damage the paintwork or plastic parts.

If the vehicle is very dirty, pre-wash it before cleaning it in an automatic car wash.

! In car washes with a towing mechanism, make sure that the automatic transmission is in transmission position **N**, otherwise the vehicle could be damaged.

- Vehicles with a SmartKey:

Do not remove the SmartKey from the ignition lock. Do not open the driver's door or front-passenger door when the engine is switched off. Otherwise, the automatic transmission selects park position **P** automatically and locks the wheels. You can prevent this by shifting the automatic transmission to **N** beforehand.

- Vehicles with KEYLESS-GO:

Do not open the driver's door or front-passenger door when the engine is switched off. Otherwise, the automatic transmission selects park position **P** automatically and locks the wheels.

Observe the following to make sure that the automatic transmission stays in position **N**:

- ▶ Make sure the vehicle is stationary and the ignition is switched off.
- ▶ Turn the SmartKey to position **2** (▷ page 145) in the ignition lock. Use the SmartKey instead of the Start/Stop button on vehicles with KEYLESS-GO.
- ▶ Depress and hold the brake pedal.
- ▶ Shift the automatic transmission to position **N**.
- ▶ Release the brake pedal.
- ▶ Release the parking brake.
- ▶ Switch off the ignition and leave the SmartKey in the ignition lock.

! Make sure that:

- the side windows and the sliding sunroof are fully closed.
- the ventilation/heating is switched off (the OFF button has been pressed).
- the windshield wiper switch is in position **0**.

Otherwise, the vehicle might be damaged.

After using an automatic car wash, wipe off wax from the windshield and the wiper blades. This will prevent smears and reduce wiping noises caused by residue on the windshield.

Washing by hand

Carefully remove all deposits of road salt as soon as possible when driving in winter.

Also, clean the insides of the wheels when washing the underbody of the vehicle.

- ▶ Do not use hot water and do not wash the vehicle in direct sunlight.
- ▶ Use a soft car sponge for cleaning.
- ▶ Use a gentle cleaning agent, e.g. a Mercedes-Benz approved car shampoo.
- ▶ Wash down the vehicle with a gentle water jet.
- ▶ Do not point the water jet directly at the air inlets.
- ▶ Use plenty of water and rinse the sponge frequently.

- ▶ Rinse the vehicle with clean water and dry it thoroughly with a chamois.
- ▶ Do not allow the cleaning agent to dry on the paintwork.

Power washers

! **WARNING**

Do not use power washers with circular-jet nozzles (dirt grinders) to clean your vehicle, in particular the tires. You could otherwise damage the tires and cause an accident.

- !** Always maintain a distance of at least 11.8 in (30 cm) between the vehicle and the power washer nozzle. Information about the correct distance is available from the equipment manufacturer.

Move the power washer nozzle around when cleaning your vehicle.

Do not aim directly at any of the following:

- tires
- door gaps, roof gaps, joints etc.
- electrical components
- battery
- connectors
- lights
- seals
- trim elements
- ventilation slots

Damaged seals or electrical components can lead to leaks or failures.

Cleaning the wheels

- !** Do not use acidic wheel cleaning products to remove brake dust. This could damage wheel bolts and brake components.

- !** Do not park the vehicle for an extended period straight after cleaning it, particularly after having cleaned the wheels with wheel cleaner. Wheel cleaners could cause increased corrosion of the brake discs and brake pads/linings. For this reason, you should drive for a few minutes after

cleaning. Braking heats the brake discs and the brake pads/linings, thus drying them. The vehicle can then be parked.

Cleaning the paintwork

Scratches, corrosive deposits, areas affected by corrosion and damage caused by inadequate care cannot always be completely repaired. In such cases, visit a qualified specialist workshop, e.g. an authorized Mercedes-Benz Center.

- ▶ Remove impurities immediately, where possible, whilst avoiding rubbing too hard.
- ▶ Soak insect remains with insect remover and rinse off the treated areas afterwards.
- ▶ Soak bird droppings with water and rinse off the treated areas afterwards.
- ▶ Remove coolant, brake fluid, tree resin, oils, fuels and greases by rubbing gently with a cloth soaked in petroleum ether or lighter fluid.
- ▶ Use tar remover to remove tar stains.
- ▶ Use silicone remover to remove wax.

❗ Do not affix:

- stickers
 - films
 - magnetic plates or similar items
- to painted surfaces. You could otherwise damage the paintwork.

If water no longer forms "beads" on the paint surface, use the paint care products recommended and approved by Mercedes-Benz. This is the case approximately every three to five months, depending on the climate conditions and the care product used.

If dirt has penetrated the paint surface or the paint has become dull, the paint cleaner recommended and approved by Mercedes-Benz should be used.

Do not use these care products in the sun or on the hood while the hood is hot.

- ▶ Use a suitable touch-up stick, e.g. MB Touch-Up Stick, to correct smaller areas of paint damage quickly and provisionally.

Matte finish care

If your vehicle has a clear matte finish, observe the following instructions in order to avoid damage to the paintwork due to incorrect care.

These notes also apply to light alloy wheels with a clear matte finish.

- ❗ Never polish the vehicle or the light alloy wheels. Polishing causes the finish to shine.
- ❗ The following may cause the paint to become shiny and thus reduce the matte effect:
 - Vigorous rubbing with unsuitable materials.
 - Frequent use of car washes.
 - Washing the vehicle in direct sunlight.
- ❗ Never use paint cleaner, buffing or polishing products, or gloss preserver, e.g. wax. These products are only suitable for high-gloss surfaces. Their use on vehicles with matte finish leads to considerable surface damage (shiny, spotted areas). Always have paintwork repairs performed at a qualified specialist workshop, e.g. an authorized Mercedes-Benz Center.
- ❗ Do not use wash programs with a hot wax treatment under any circumstances.
- i The vehicle should preferably be washed by hand using a soft sponge, car shampoo and plenty of water.
- i Use only insect remover and car shampoo from the range of recommended and approved Mercedes-Benz care products.

Cleaning the windows

WARNING

Before cleaning the windshield or wiper blades, switch off the windshield wipers and remove the SmartKey from the ignition lock. On vehicles with KEYLESS-GO, press the Start/Stop button repeatedly until all indicator lamps in the instrument cluster have gone out. The windshield wipers could otherwise move and injure you.

- ▶ Clean the inside and outside of the windows with a damp cloth and a cleaning agent that is recommended and approved by Mercedes-Benz.
- ❗ Do not use dry cloths, abrasive products, solvents or cleaning agents containing solvents to clean the inside of the windows. Do not touch the insides of the windows with hard objects, e.g. an ice scraper or ring. There is otherwise a risk of damaging the windows.
- ❗ Clean the water drainage channels of the windshield and the rear window at regular intervals. Deposits such as leaves, petals and pollen may under certain circumstances prevent water from draining away. This can lead to corrosion damage and damage to electronic components.

Cleaning the wiper blades

WARNING

Before cleaning the windshield or wiper blades, switch off the windshield wipers and remove the SmartKey from the ignition lock. On vehicles with KEYLESS-GO, press the Start/Stop button repeatedly until all indicator lamps in the instrument cluster have gone out. The windshield wipers could otherwise move and injure you.

- ❗ Do not pull the wiper blade. Otherwise, the wiper blade could be damaged.

- ❗ Do not clean wiper blades too often and do not rub them too hard. Otherwise, the graphite coating could be damaged. This could cause wiper noise.

- ▶ Fold the wiper arms away from the windshield.
- ▶ Carefully clean the wiper blades with a damp cloth.
- ▶ Fold the windshield wipers back again before switching on the ignition.

- ❗ Hold the wiper arm securely when folding back. The windshield could be damaged if the wiper arm smacks against it suddenly.

Cleaning the exterior lighting

- ▶ Clean the plastic lenses of the exterior lights with a wet sponge and a mild cleaning agent, e.g. Mercedes-Benz car shampoo or cleaning cloths.

- ❗ Only use cleaning agents or cleaning cloths which are suitable for plastic light lenses. Unsuitable cleaning agents or cleaning cloths could scratch or damage the plastic light lenses.

Cleaning the sensors

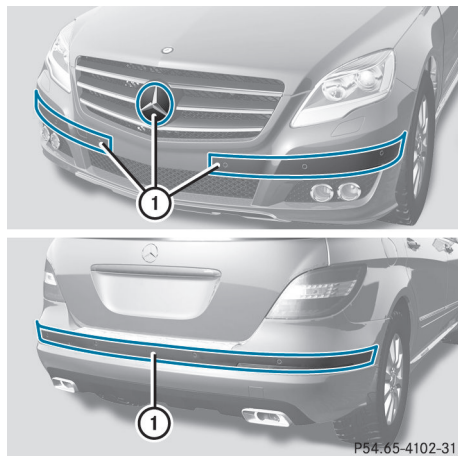

- ▶ Clean sensors ① of the driving systems with water, car shampoo and a soft cloth.

- ❗ When cleaning the sensors with a power washer, maintain a distance between the vehicle and the nozzle of the power washer of at least 11.8 in (30 cm). Information about the correct distance is available from the equipment manufacturer.

Cleaning the rear view camera

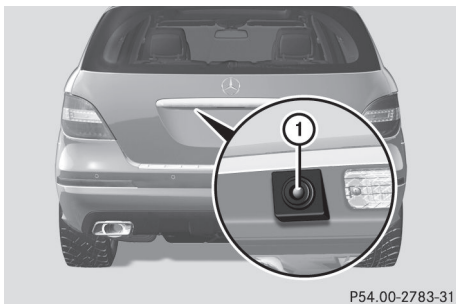

- ▶ Use clear water and a soft cloth to clean camera lens ①.
- ❗ Do not clean the camera lens and the area around the rear view camera with a power washer.

Cleaning the exhaust tail pipes

Impurities combined with the effects of road grit and corrosive environmental factors may cause flash rust to form on the surface. You can restore the original shine of the exhaust tail pipe by cleaning it regularly, especially in winter and after washing.

- ❗ Do not clean the exhaust tail pipes with alkaline-based cleaning agents, such as wheel cleaner.
- ▶ Clean the exhaust tail pipes with a chrome care product tested and approved by Mercedes-Benz.

Interior care

Cleaning the display

- ▶ Before cleaning the display, make sure that it is switched off and has cooled down.
- ▶ Clean the display surface using a commercially-available microfiber cloth and TFT/LCD display cleaner.
- ▶ Dry the display surface using a dry microfiber cloth.

- ❗ For cleaning, do not use any of the following:

- alcohol-based thinner or gasoline
- abrasive cleaning agents
- commercially-available household cleaning agents

These may damage the display surface. Do not put pressure on the display surface when cleaning. This could lead to irreparable damage to the display.

Cleaning the plastic trim

WARNING

When cleaning the steering wheel boss and dashboard, do not use cockpit sprays or cleaning agents containing solvents. Cleaning agents containing solvents cause the surface to become porous, and as a result, plastic parts may break away and be thrown around the interior when an air bag is deployed, which may result in severe injuries.

- ❗ Do not affix the following to plastic surfaces:
 - stickers
 - films
 - scented oil bottles or similar items
 You can otherwise damage the plastic.
- ❗ Do not allow cosmetics, insect repellent or sunscreen to come into contact with the plastic trim. This maintains the high-quality look of the surfaces.

- ▶ Wipe the plastic trim with a damp, lint-free cloth, e.g. a microfiber cloth.
- ▶ **Heavy soiling:** use car care and cleaning products recommended and approved by Mercedes-Benz.
The surface may change color temporarily. Wait until the surface is dry again.

Cleaning the steering wheel and gear or selector lever

- ▶ Thoroughly wipe with a damp cloth or use leather care agents that have been recommended and approved by Mercedes-Benz.

Cleaning genuine wood and trim elements

- ▶ Wipe the wooden trim and trim pieces with a damp, lint-free cloth, e.g. a microfiber cloth.
- ▶ **Heavy soiling:** use car care and cleaning products recommended and approved by Mercedes-Benz.

! Do not use solvent-based cleaning agents such as tar remover, wheel cleaners, polishes or waxes. There is otherwise a risk of damaging the surface.

! Do not use chrome polish on trim pieces. The trim pieces have a chrome look but are mostly made of anodized aluminum and can lose their shine if chrome polish is used. Use a damp, lint-free cloth instead when cleaning the trim pieces.

If the chrome-plated trim pieces are very dirty, you can use a chrome polish. If you are unsure as to whether the trim pieces are chrome-plated or not, consult an authorized Mercedes-Benz Center.

Cleaning the seat covers

! Do not use microfiber cloths to clean genuine leather, artificial leather or Alcantara® covers. If used often, these can damage the cover.

! Observe the following when cleaning:

- clean genuine leather covers carefully with a damp cloth and then wipe the covers down with a dry cloth. Make sure that the leather does not become soaked. It may otherwise become rough and cracked. Only use leather care agents that have been tested and approved by Mercedes-Benz. You can obtain these from a qualified specialist workshop, e.g. a Mercedes-Benz Service center.
- clean artificial leather covers with a cloth moistened with a solution containing 1% detergent (e.g. dish washing liquid).
- clean cloth covers with a microfiber cloth moistened with a solution containing 1% detergent (e.g. dish washing liquid). Rub carefully and always wipe entire seat sections to avoid leaving visible lines. Leave the seat to dry afterwards. Cleaning results depend on the type of dirt and how long it has been there.
- clean Alcantara® covers with a damp cloth. Make sure you wipe entire seat sections to avoid leaving visible lines.

i Note that regular care is essential to ensure that the appearance and comfort of the covers is retained over time.

Cleaning the seat belts

- ▶ Use clean, lukewarm water and soap solution.

! Do not clean the seat belts using chemical cleaning agents. Do not dry the seat belts by warming them above 176 °F (80 °C) or placing them in direct sunlight.

⚠ WARNING

Do not bleach or dye seat belts as this may severely weaken them. In a crash, they may not be able to provide adequate protection.

Cleaning the headliner and carpets

- ▶ **Roof lining:** use soft brushes or dry shampoo if it is particularly dirty.
- ▶ **Carpets:** use carpet and textile cleaners that have been approved and recommended by Mercedes-Benz.

Useful information	296
Where will I find...?	296
Flat tire	299
Battery	310
Jump-starting	313
Towing and tow-starting	315
Fuses	317

Useful information

- i** This Operator's Manual describes all models and all standard and optional equipment of your vehicle available at the time of publication of the Operator's Manual. Country-specific differences are possible. Please note that your vehicle may not be equipped with all features described. This also applies to safety-related systems and functions.
- i** Please read the information on qualified specialist workshops (▷ page 24).

Where will I find...?

First-aid kit

The first-aid kit can be found under the trunk floor in the vehicle tool kit stowage tray. Depending on the vehicle's equipment, the location of the first-aid kit may differ slightly from that shown in the example illustration.

- ▶ Open the tailgate.
- ▶ Lift the trunk floor up (▷ page 296).

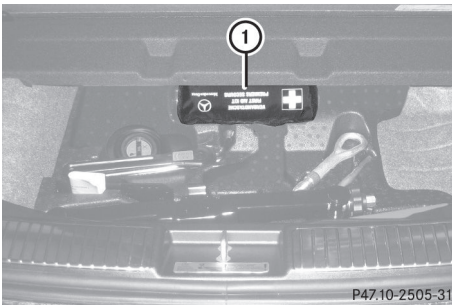

Example: vehicles with BlueTEC

- ▶ Remove first-aid kit ①.
- i** Check the expiration date on the first-aid kit at least once a year. Replace the contents if necessary, and replace missing contents.

Vehicle tool kit

Notes

The vehicle tool kit can be found in the stowage well under the cargo compartment floor.

- i** Vehicles are not equipped with the tools needed to change a wheel when they leave the factory, e.g. jack or lug wrench. Country-specific differences are possible. Some tools for changing a wheel are specific to the vehicle. To obtain tools approved for your vehicle, visit a qualified specialist workshop, e.g. an authorized Mercedes-Benz Center.

Folding the cargo compartment floor up

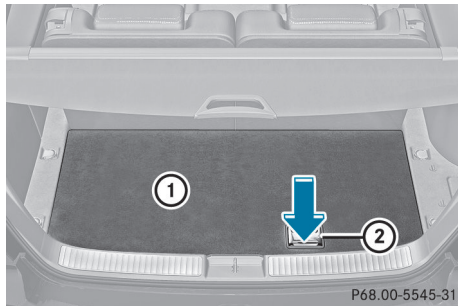

- ▶ Press release handle ② in the direction of the arrow.
- ▶ Lift cargo compartment floor ① up by release handle ②.

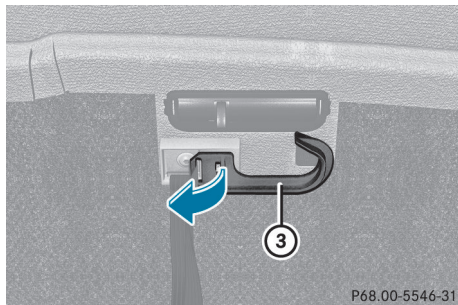

- ▶ Fold out hook ③ on the underside of the cargo compartment floor.

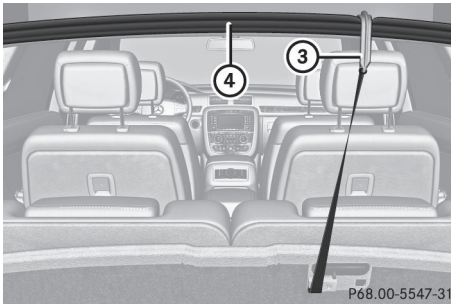

- ▶ Attach hook (3) to upper seal (4) in the cargo compartment.

Vehicles with a TIREFIT kit

- ▶ Lift the trunk floor up (▷ page 296).

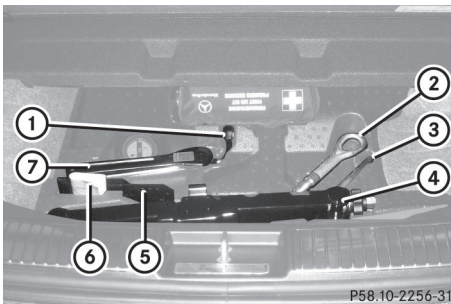

- ① Lug wrench
- ② Towing eye
- ③ Alignment bolt
- ④ Jack
- ⑤ Folding wheel chock
- ⑥ Fuse allocation chart
- ⑦ Ratchet wrench

Vehicles with a collapsible spare wheel

- ▶ Lift the trunk floor up (▷ page 296).

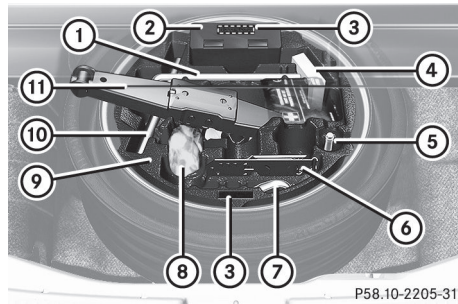

- ① Lug wrench
- ② Tire inflation compressor
- ③ Instructions on the installation position of the vehicle tool kit holder
- ④ Fuse allocation chart
- ⑤ Alignment bolt
- ⑥ Folding wheel chock
- ⑦ Towing eye
- ⑧ Wheel bolts
- ⑨ Stowage well
- ⑩ Ratchet wrench
- ⑪ Jack

Collapsible spare wheel

Removing the collapsible spare wheel

The collapsible spare wheel can be found in the stowage well under the trunk floor.

- ▶ Lift the trunk floor up (▷ page 296).
- ▶ Remove the jack from the tool holder (▷ page 296).

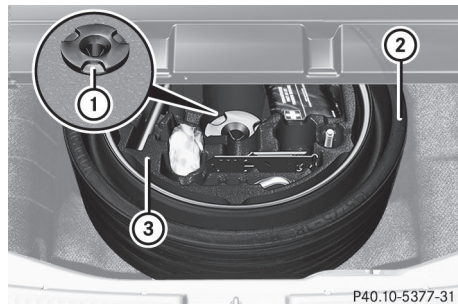

- ▶ Turn retaining screw ① counter-clockwise and out of tool holder ③ and remove it.

i If retaining screw ① does not come out immediately, turn tool holder ③ slightly counter-clockwise. Retaining screw ① can then be unscrewed with ease.

- ▶ Turn tool holder ③ approximately 180°, so that the tire inflation compressor points backwards.
- ▶ Remove tool holder ③ from collapsible spare wheel ②.
- ▶ Remove collapsible spare wheel ② from the emergency spare wheel well.

For further information on changing a wheel and mounting the spare wheel, see (▷ page 299).

Stowing a used collapsible spare wheel

Take the following steps to stow a used collapsible spare wheel. It will otherwise not fit in the spare wheel well. Mercedes-Benz recommends that you have this work carried out at a qualified specialist workshop, e.g. an authorized Mercedes-Benz Center.

- !** Only place the collapsible spare wheel in the vehicle when it is dry. Otherwise, moisture may get into the vehicle.
- ▶ Unscrew the valve cap from the valve.
- ▶ If possible, unscrew the valve insert from the valve and release the air.
- i** Fully deflating the tire can take a few minutes.
- ▶ Screw the valve insert back into the valve.
- ▶ Screw the valve cap back on.

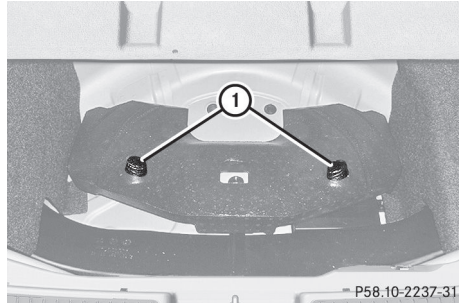

In the spare wheel well, there are two guides ① to keep the collapsible spare wheel in place.

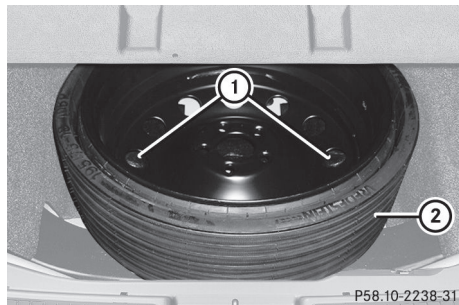

- ▶ Lay collapsible spare wheel ② in the emergency spare wheel well.
- i** Make sure that collapsible spare wheel ② is positioned on guides ① precisely.
- ▶ Lay the tool holder in collapsible spare wheel ② so that the electric air pump is pointing towards the tailgate (▷ page 296).
- ▶ Turn the tool holder approximately 180°, so that the electric air pump points forwards. The tool holder should now be positioned in accordance with the instructions on the installation position.
- ▶ Turn the retainer screw on the collapsible spare wheel clockwise into the tool holder as far as it will go.
- ▶ Stow the jack in the vehicle tool kit.

Flat tire

Preparing the vehicle

Your vehicle may be equipped with a collapsible spare wheel or MOExtended tires (tires with run-flat properties) (▷ page 309).

- i** Vehicle preparation is not necessary on vehicles with MOExtended tires.
- i** Vehicles equipped with MOExtended tires are not equipped with a TIREFIT kit at the factory. It is therefore recommended that you additionally equip your vehicle with a TIREFIT kit if you mount tires that do not feature run-flat properties, e.g. winter tires. A TIREFIT kit can be obtained from an authorized Mercedes-Benz Center.
- ▶ Vehicles with the AIRMATIC package: make sure that highway level is selected (▷ page 180).
- ▶ Stop the vehicle as far away as possible from traffic on solid, non-slippery and level ground.
- ▶ Switch on the hazard warning lamps.
- ▶ Firmly depress the parking brake.
- ▶ Bring the front wheels into the straight-ahead position.
- ▶ Move the DIRECT SELECT lever to **P**.
- ▶ Switch off the engine.
- ▶ **Vehicles without KEYLESS-GO:** remove the SmartKey from the ignition lock.
- ▶ **Vehicles with KEYLESS-GO:** open the driver's door. The on-board electronics have status **0**, which is the same as the SmartKey having been removed.
- ▶ **Vehicles with KEYLESS-GO:** remove the Start/Stop button from the ignition lock (▷ page 145).
- ▶ All occupants must get out of the vehicle. Make sure that they are not endangered as they do so.
- ▶ Make sure that no one is near the danger area while a wheel is being changed.

Anyone who is not directly assisting in the wheel change should, for example, stand behind the barrier.

- ▶ Get out of the vehicle. Pay attention to traffic conditions when doing so.
- ▶ Close the driver's door.

- i** Only operate the tire inflation compressor using the socket in the footwell of the second row of seats (▷ page 268), even if the ignition is turned off.

An emergency cut-off ensures that the on-board electrical system voltage does not drop too low. If the on-board electrical system voltage is too low, power to the sockets is automatically cut off. This ensures that there is sufficient power to start the engine.

TIREFIT kit

Using the TIREFIT kit

You can use the TIREFIT kit to seal small punctures, particularly those in the tire tread. You can use TIREFIT at outside temperatures down to -4 °F (-20 °C).

WARNING

TIREFIT is a limited repair device. TIREFIT cannot be used for cuts or punctures larger than approximately 0.16 in (4 mm) and tire damage caused by driving with extremely low tire inflation pressure, or on a flat tire, or a damaged wheel.

Do not drive the vehicle under such circumstances.

Contact the nearest authorized Mercedes-Benz Center for assistance or call Roadside Assistance.

- ▶ Do not remove any foreign objects which have penetrated the tire, e.g. screws or nails.
- ▶ Remove the tire sealant bottle, the accompanying "max. 80 km/h" sticker and the tire inflation compressor from the

stowage well underneath the trunk floor (▷ page 296).

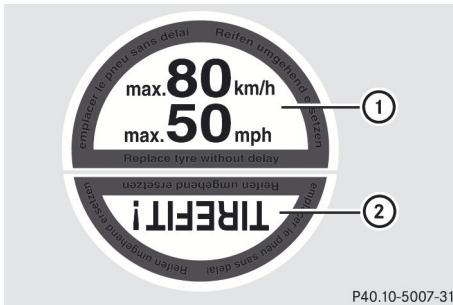

P40.10-5007-31

Breakdown assistance

- ▶ Affix part ① of the sticker within the driver's field of vision.
- ▶ Affix part ② of the sticker near the valve on the wheel with the defective tire.

⚠ WARNING

Take care not to allow the contents of TIREFIT to come in contact with hair, eyes or clothing. TIREFIT is harmful if inhaled, swallowed or absorbed through the skin - causes skin, eye and respiratory irritation.

Any contact with eyes or skin should be flushed immediately with plenty of water.

If clothing comes in contact with TIREFIT, change clothing as soon as possible.

In case of allergic reaction or rash, consult a physician immediately.

⚠ WARNING

Keep TIREFIT away from children. If swallowed, rinse mouth immediately with plenty of water and drink plenty of water. Do not induce vomiting.

Consult a doctor immediately.

Keep away from open flame or heat source.

- ❗ If TIREFIT leaks out, allow it to dry. It can then be removed like a layer of film. If you get TIREFIT on your clothing, have it cleaned as soon as possible with perchloroethylene.

Your vehicle is provided with one of two different tire inflation compressors:

- **Version 1:** the hose with the pressure gauge and the cable are behind a flap.
- **Version 2:** the pressure gauge is in the tire inflation compressor.

TIREFIT kit version 1

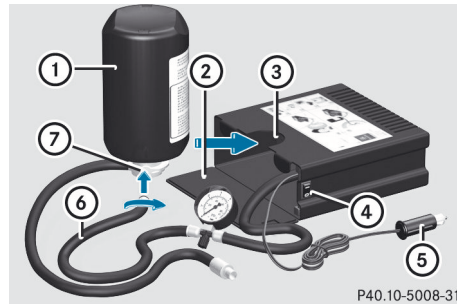

P40.10-5008-31

- ▶ Open flap ②.
- ▶ Pull connector ⑤ with the cable and hose ⑥ out of the housing.
- ▶ Screw hose ⑥ onto flange ⑦ of tire sealant bottle ①.
- ▶ Insert tire sealant bottle ① head downwards into recess ③ of the tire inflation compressor.

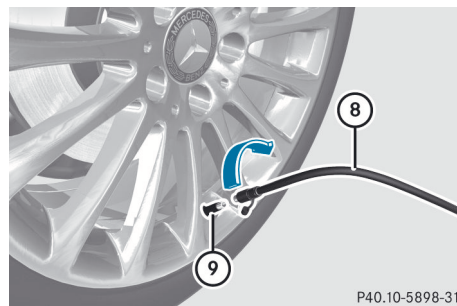

P40.10-5898-31

- ▶ Remove the cap from valve ⑨ on the faulty tire.

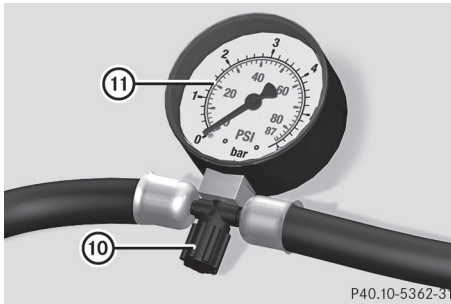

P40.10-5362-31

- ▶ Make sure pressure release screw (10) on pressure gauge (11) is fully closed.
- ▶ Screw filler hose (8) onto valve (9).
- ▶ Insert connector (5) into the socket in the footwell of the second row of seats (▷ page 268).

! None of the other sockets or cigarette lighters are designed for operating the tire inflation compressor.

- ▶ Turn the SmartKey to position 1 (▷ page 145) in the ignition lock.
- ▶ Press on/off switch (4) on the tire inflation compressor to I.
The tire inflation compressor is switched on. The tire is inflated.

i First, TIREFIT is pumped into the tire. The pressure can briefly rise to approximately 500 kPa (5 bar/73 psi).

Do not switch off the tire inflation compressor during this phase.

- ▶ Allow the tire inflation compressor to run for five minutes. The tire should then have attained a pressure of at least 180 kPa (1.8 bar/26 psi).

! Do not operate the tire inflation compressor for longer than eight minutes at a time without a break. It may otherwise overheat.

The tire inflation compressor can be operated again once it has cooled down.

If a pressure of 180 kPa (1.8 bar/26 psi) has been achieved after five minutes, see (▷ page 302).

If a pressure of 180 kPa (1.8 bar/26 psi) has not been achieved after five minutes, see (▷ page 302).

TIREFIT kit version 2

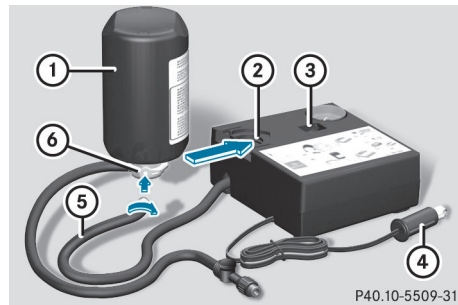

P40.10-5509-31

- ▶ Pull connector (4) with the cable and hose (5) out of the housing.
- ▶ Screw hose (5) onto flange (6) of tire sealant bottle (1).
- ▶ Insert tire sealant bottle (1) head downwards into recess (2) of the tire inflation compressor.

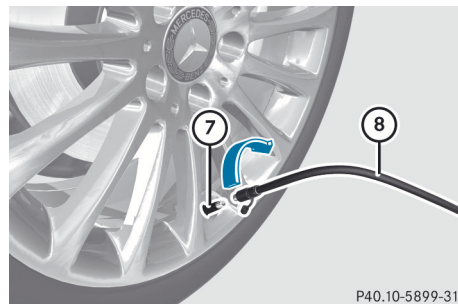

P40.10-5899-31

- ▶ Remove the cap from valve (7) on the faulty tire.
- ▶ Screw filler hose (8) onto valve (7).
- ▶ Insert connector (4) into the socket in the footwell of the second row of seats (▷ page 268).

! None of the other sockets or cigarette lighters are designed for operating the tire inflation compressor.

- ▶ Turn the SmartKey to position 1 (▷ page 145) in the ignition lock.
- ▶ Press on/off switch ③ on the tire inflation compressor to I.
The tire inflation compressor is switched on. The tire is inflated.

i First, TIREFIT is pumped into the tire. The pressure can briefly rise to approximately 500 kPa (5 bar/73 psi).

Do not switch off the tire inflation compressor during this phase.

- ▶ Allow the tire inflation compressor to run for five minutes. The tire should then have attained a pressure of at least 180 kPa (1.8 bar/26 psi).

! Do not operate the tire inflation compressor for longer than eight minutes at a time without a break. It may otherwise overheat.

The tire inflation compressor can be operated again once it has cooled down.

If a pressure of 180 kPa (1.8 bar/26 psi) has been achieved after five minutes, see (▷ page 302).

If a pressure of 180 kPa (1.8 bar/26 psi) has not been achieved after five minutes, see (▷ page 302).

Tire pressure of at least 180 kPa (1.8 bar/26 psi) is not reached

If, after five minutes, a pressure of 180 kPa (1.8 bar/26 psi) has not been achieved:

- ▶ Press the on/off switch on the tire inflation compressor to 0.
The tire inflation compressor is switched off.
- ▶ Unscrew the filler hose from the valve of the faulty tire.

- ▶ Very slowly drive forwards or reverse approximately 30 ft (10 m).

- ▶ Pump up the tire again.

⚠ WARNING

If after five minutes a pressure of 180 kPa (1.8 bar/26 psi) cannot be achieved, the tire is too badly damaged to be repaired reliably using TIREFIT.

In this case TIREFIT cannot seal the tire properly.

Do not drive any further.

Contact the nearest authorized Mercedes-Benz Center for assistance or call Roadside Assistance.

Tire pressure of 180 kPa (1.8 bar/26 psi) is reached

- ▶ Press the on/off switch on the tire inflation compressor to 0.

The tire inflation compressor is switched off.

- ▶ Unscrew the filler hose from the valve of the faulty tire.

! After use, excess TIREFIT may run out of the filler hose. This could cause stains.

Therefore, place the filler hose in the plastic bag which contained the TIREFIT kit.

- ▶ Stow the tire sealant bottle and the tire inflation compressor.

- ▶ **Pull away immediately.**

⚠ WARNING

Do not exceed a vehicle speed of 50 mph (80 km/h). A TIREFIT repair is not designed to operate at higher speeds.

The sticker must be attached on the instrument cluster where it will be easily seen by the driver.

Vehicle handling characteristics of a TIREFIT repaired tire may change. Adapt your driving accordingly.

- ▶ Stop after driving for approximately ten minutes and check the tire pressure with the tire inflation compressor.

WARNING

If tire inflation pressure has fallen below 130 kPa (1.3 bar/26 psi) do not continue to drive the vehicle.

Park your vehicle safely away from the roadway and contact the nearest authorized Mercedes-Benz Center or Roadside Assistance.

Have the damaged tire replaced.

- ▶ Correct the tire pressure if it is at least 130 kPa (1.3 bar/20 psi) (for the required values, see the Tire and Loading Information placard on the driver's side B-pillar or the tire pressure table inside the fuel filler flap).
- ▶ **To increase the tire pressure:** switch on the tire inflation compressor.

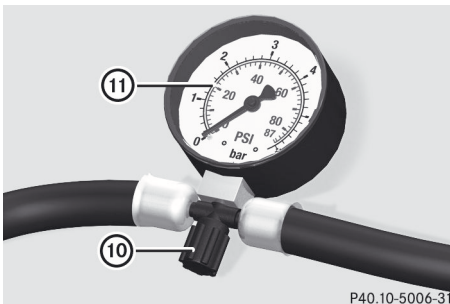

P40.10-5006-31

TIREFIT kit version 1

- ▶ **To reduce the tire pressure (version 1):** open pressure release screw ⑩ on pressure gauge ⑪.

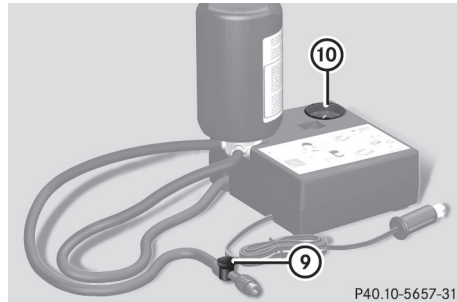

P40.10-5657-31

TIREFIT kit version 2

⑨ Pressure release button

⑩ Pressure gauge

- ▶ **To reduce the tire pressure (version 2):** press pressure release button ⑨ on the filler hose.
- ▶ Stow the tire sealant bottle and the tire inflation compressor.
- ▶ Drive to the nearest workshop and have the tire changed there.
- ▶ Have the tire sealant bottle replaced as soon as possible at a qualified specialist workshop, e.g. at an authorized Mercedes-Benz Center.

Environmental note

Have the used tire sealant bottle disposed of professionally, e.g. at an authorized Mercedes-Benz Center.

- ▶ Have the tire sealant bottle replaced every four years at a qualified specialist workshop, e.g. an authorized Mercedes-Benz Center.

Changing a wheel and mounting the spare wheel

Preparing the vehicle

WARNING

The wheel and tire size of the emergency spare wheel/spare wheel may differ to that of the damaged wheel. When using an emergency spare wheel/spare wheel the

handling characteristics of the vehicle may change.

Adapt your style of driving accordingly.

Never operate the vehicle with more than one emergency spare wheel/spare wheel that differs in size.

Only use an emergency spare wheel/spare wheel of a differing size briefly and do not switch off ESP®.

When using an emergency spare wheel, you must not exceed the maximum speed of 50 mph (80 km/h).

Breakdown assistance

WARNING

Have the emergency spare wheel/spare wheel replaced with a new wheel as soon as possible at a qualified specialist workshop which has the necessary specialist knowledge and tools to carry out the work required. Mercedes-Benz recommends that you use an authorized Mercedes-Benz Center for this purpose. In particular, work relevant to safety or on safety-related systems must be carried out at a qualified specialist workshop.

i Vehicles without a spare wheel/emergency spare wheel are not equipped with a tire-change tool kit at the factory. For more information on which tools are required to perform a wheel change on your vehicle, e.g. wheel chock, lug wrench or alignment bolt, consult an authorized Mercedes-Benz Center.

- ▶ Prepare the vehicle as described (> page 299).
- ▶ If a trailer is coupled to the vehicle, uncouple it.
- ▶ Remove the following items (depending on the vehicle's equipment) from the stowage well under the trunk floor:
 - the emergency spare wheel³⁵
 - the wheel bolts for the emergency spare wheel³⁵
 - the jack

³⁵ Vehicles with an emergency spare wheel.

- the ratchet wrench
- the lug wrench
- the folding wheel chock
- the alignment bolt
- the tire inflation compressor³⁵

- ▶ Secure the vehicle to prevent it from rolling away.

Securing the vehicle to prevent it from rolling away

WARNING

Only jack up the vehicle on level ground or on slight inclines/declines. The vehicle could otherwise fall off the jack and injure you or others.

If your vehicle is equipped with a wheel chock, it can be found in the vehicle tool kit (> page 296).

The folding wheel chock is an additional securing measure to prevent the vehicle from rolling away, for example when changing a wheel.

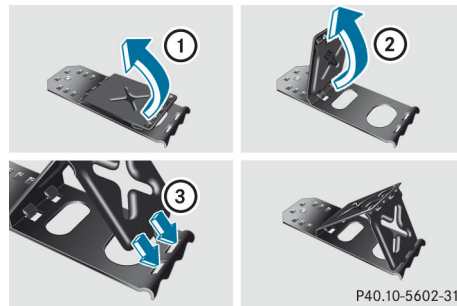

- ▶ Fold both plates upwards ①.
- ▶ Fold out lower plate ②.
- ▶ Guide the lugs on the lower plate fully into the openings in base plate ③.



P40.10-5887-31

Securing the vehicle on level ground

- **On level ground:** place chocks or other suitable items under the front and rear of the wheel that is diagonally opposite the wheel you wish to change.

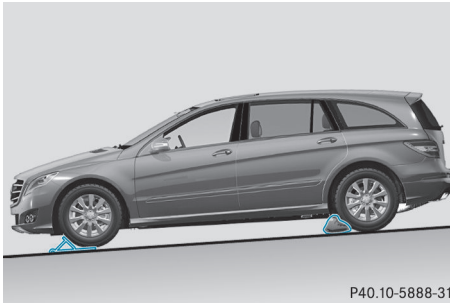

P40.10-5888-31

Securing the vehicle on slight downhill gradients

- **On downhill gradients:** place chocks or other suitable items in front of the wheels of the front and rear axle.

Raising the vehicle

WARNING

When jacking up the vehicle, only use the jack which has been specifically approved by Mercedes-Benz for your vehicle.

The jack is designed exclusively for jacking up the vehicle at the jacking points built into both sides of the vehicle. The jack saddle must be placed centrally under the jacking point. The jack must always be vertical when in use, especially on inclines or declines.

The jack is intended only for lifting the vehicle briefly for wheel changes. It is not suited for

performing maintenance work under the vehicle. To help avoid personal injury, use the jack only to lift the vehicle during a wheel change.

Never get beneath the vehicle while it is supported by the jack. Keep hands and feet away from the area under the lifted vehicle. Always lower the vehicle onto sufficient capacity jackstands before working under the vehicle.

Always firmly engage the parking brake and block the wheels with wheel chocks or other sizable objects before raising the vehicle with the jack. Do not disengage the parking brake while the vehicle is raised.

Make sure that the ground on which the vehicle is standing and where you place the jack is solid, level and not slippery. If necessary, use a large underlay. On slippery surfaces, such as tiled floors, you should use a non-slip underlay, for example a rubber mat.

Do not use wooden blocks or similar objects as a jack underlay. Otherwise, the jack may not be able to achieve its load-bearing capacity if it is not at its full height.

Never start the engine when the vehicle is raised.

Also observe the notes on the jack.

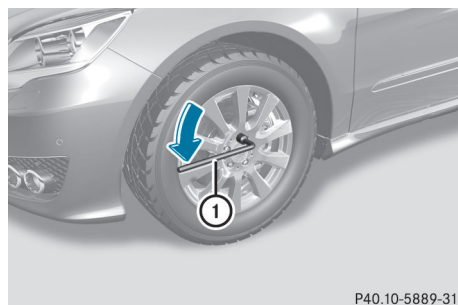

P40.10-5889-31

- Using lug wrench ①, loosen the bolts on the wheel you wish to change by about one full turn. Do not unscrew the bolts completely.

The jacking points for the jack are located behind the wheel housings of the front wheels

and in front of the wheel housings of the rear wheels (arrows).

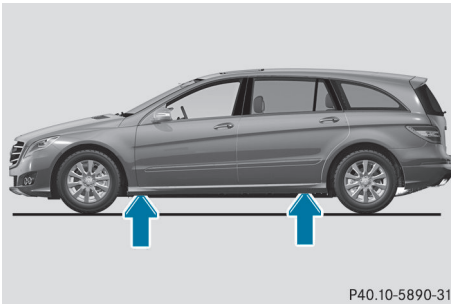

P40.10-5890-31

Breakdown assistance

⚠ WARNING

The jack is designed exclusively for jacking up the vehicle at the jacking points. The jack saddle must be placed centrally under the jacking point.

If you do not position the jack correctly in the jacking point, the vehicle can fall off the jack and seriously or fatally injure you or others.

❗ The jack is designed exclusively for jacking up the vehicle at the jacking points. Otherwise, your vehicle could be damaged.

- ▶ Take ratchet wrench out of the vehicle tool kit and place it on the hexagon nut of the jack so that the letters **AUF** are visible.

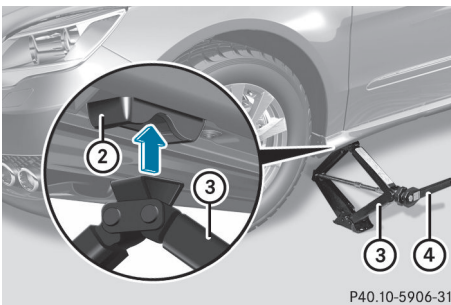

P40.10-5906-31

- ▶ Position jack (3) at jacking point (2).

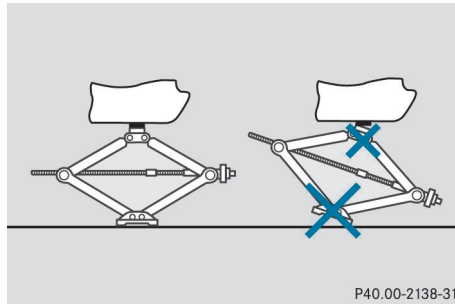

P40.00-2138-31

- ▶ Make sure that the base of the jack is positioned directly under the jacking point.
- ▶ Turn ratchet wrench (4) until jack (3) sits completely on jacking point (2) and the base of the jack lies evenly on the ground.
- ▶ Turn ratchet wrench (4) until the tire is raised a maximum of 1.2 inches (3 cm) off the ground.

Removing a wheel

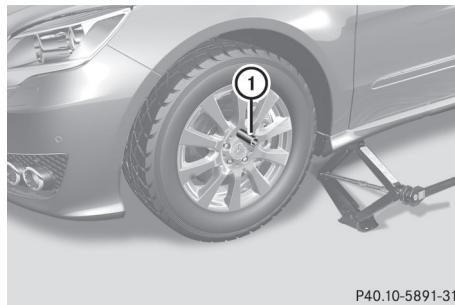

P40.10-5891-31

- ▶ Unscrew the uppermost wheel bolt completely.
- ▶ Screw alignment bolt (1) into the thread instead of the wheel bolt.
- ▶ Unscrew the remaining wheel bolts fully.

❗ Do not place wheel bolts in sand or on a dirty surface. The bolt and wheel hub threads could otherwise be damaged when you screw them in.

- ▶ Remove the wheel.

Mounting a new wheel

WARNING

Always replace wheel bolts that are damaged or rusted.

Never apply oil or grease to wheel bolts.

Damaged wheel hub threads should be repaired immediately. Do not continue to drive under these circumstances! Contact an authorized Mercedes-Benz Center or call Roadside Assistance.

Incorrect wheel bolts or improperly tightened wheel bolts can cause the wheel to come off. This could cause an accident. Make sure to use the correct wheel bolts.

WARNING

Only use genuine Mercedes-Benz wheel bolts. Other wheel bolts may come loose.

Do not tighten the wheel bolts when the vehicle is raised. Otherwise, the vehicle could fall off the jack.

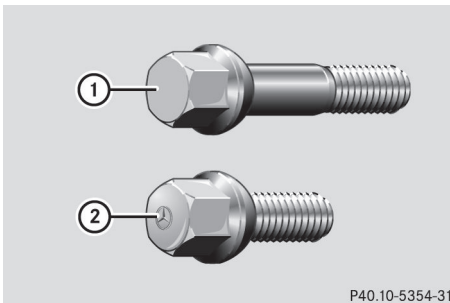

P40.10-5354-31

- ① Wheel bolts for 18", 19" and 20" wheels
- ② Wheel bolts for the collapsible spare wheel

! Always use wheel bolts ② to mount the collapsible spare wheel. Using other wheel bolts to mount the collapsible spare wheel could damage the brake system.

WARNING

Make sure to use the original length wheel bolts when remounting the original wheel after it has been repaired.

► Clean the wheel and wheel hub contact surfaces.

! To prevent damage to the paintwork, hold the wheel securely against the wheel hub while screwing in the first wheel bolt.

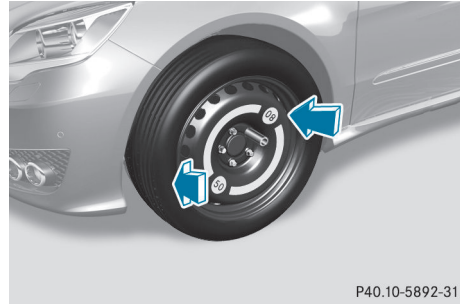

P40.10-5892-31

- Slide the emergency spare wheel onto the alignment bolt and push it on.
- Tighten the wheel bolts until they are finger-tight.
- Unscrew the alignment bolt.
- Tighten the last wheel bolt until it is finger-tight.
- Inflate the collapsible spare wheel (► page 307).

Inflating the collapsible spare wheel

WARNING

Inflate the collapsible spare wheel only after the wheel is properly attached.

Inflate the collapsible spare wheel using the tire inflation compressor **before** lowering the vehicle.

Your vehicle is equipped with one of two tire inflation compressors:

- **Version 1:** tire inflation compressor with a pressure gauge on the air hose
- **Version 2:** tire inflation compressor with an integrated pressure gauge

The following description applies to both versions. Differences in the way they are used will be explained in detail.

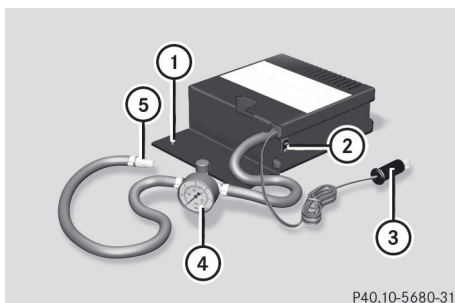

P40.10-5680-31

Version 1

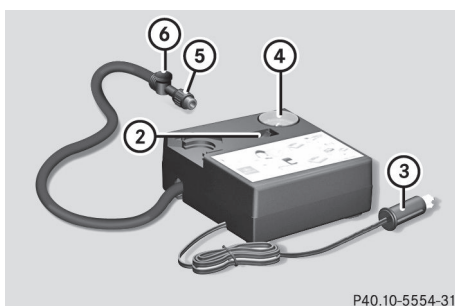

P40.10-5554-31

Version 2

Breakdown assistance

- ▶ **Version 1:** open flap ①.
- ▶ **Version 1:** pull connector ③ and the air hose with pressure gauge ④ out of the housing.
- ▶ **Version 2:** pull connector ③ and the air hose out of the housing.
- ▶ **Version 1:** make sure that the pressure release screw on pressure gauge ④ is closed.
- ▶ Remove the cap from the valve on the collapsible spare wheel.
- ▶ Screw union nut ⑤ on the air hose onto the valve.
- ▶ Make sure on/off switch ② of the tire inflation compressor is set to **0**.
- ▶ Insert plug ③ into the socket in the footwell of the second row of seats (> page 268).

! None of the other sockets or cigarette lighters are designed for operating the tire inflation compressor.

- ▶ Make sure that the SmartKey is in position **1** (> page 145) in the ignition lock.
- ▶ Press on/off switch ② on the tire inflation compressor to **I**.
The tire inflation compressor is switched on. The tire is inflated. Gauge ④ shows the tire pressure.

! Do not operate the tire inflation compressor for longer than eight minutes at a time without a break. It may otherwise overheat.

The tire inflation compressor can be operated again once it has cooled down.

- ▶ Inflate the tire to the specified tire pressure.
The specified tire pressure is printed on the yellow label of the emergency spare wheel.
- ▶ When the specified tire pressure has been reached, press on/off switch ② on the electric air pump to **0**.
The tire inflation compressor is switched off.

- ▶ Turn the SmartKey to position **0** in the ignition lock.
- ▶ **Version 1:** if the tire pressure is higher than the specified pressure, open the pressure release screw on pressure gauge ④ until the correct tire pressure has been reached.
- ▶ **Version 2:** if the tire pressure is higher than the specified pressure, press pressure release button ⑥ until the correct tire pressure has been reached.
- ▶ Unscrew union nut ⑤ on the air hose from the valve.
- ▶ Screw the valve cap onto the collapsible spare wheel valve again.
- ▶ **Version 1:** stow plug ③ and the air hose behind flap ①.
- ▶ **Version 2:** stow plug ③ and the air hose in the lower section of the compressor housing.
- ▶ Stow the tire inflation compressor in the designated place in the vehicle.

Lowering the vehicle

WARNING

Pump up the collapsible spare wheel before lowering the vehicle. You could otherwise damage the wheel rim.

- ▶ Place the ratchet wrench onto the hexagon nut of the jack so that the letters **AB** are visible.
- ▶ Turn the ratchet wrench until the vehicle is once again standing firmly on the ground.
- ▶ Place the jack to one side.

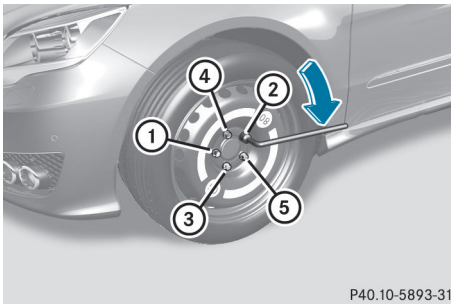

- ▶ Tighten the wheel bolts evenly in a crosswise pattern in the sequence indicated (① to ⑤). The tightening torque must be **110 lb-ft (150 Nm)**.

WARNING

Have the tightening torque checked immediately after a wheel is changed. The wheels could come loose if they are not tightened to a torque of **110 lb/ft (150 Nm)**.

- ▶ Turn the jack back to its initial position and store it together with the rest of the vehicle tool kit in the cargo compartment.
 - ▶ Transport the defective wheel in the cargo compartment.
- or
- ▶ Depending on the size of the wheel, you may also be able to secure the defective wheel in the emergency spare wheel well. In this case, you must remove the stowage

tray from the emergency spare wheel well and store it securely in the cargo compartment.

For further information on stowing the collapsible spare wheel, see (> page 298).

- i** When you are driving with the collapsible spare wheel mounted, the tire pressure loss warning system or the tire pressure monitoring system cannot function reliably. Only restart the tire pressure loss warning system/tire pressure monitoring system when the defective wheel has been replaced with a new wheel.

Vehicles with tire pressure monitoring system: all mounted wheels must be equipped with functioning sensors and the defective wheel should no longer be in the vehicle.

MOExtended tires (tires with run-flat properties)

MOExtended tires (tires with run-flat properties) allow you to continue driving your vehicle even if one or more tires are entirely deflated.

MOExtended tires may only be used in conjunction with the activated tire pressure loss warning system or with the activated tire pressure monitoring system.

The maximum permissible distance which can be driven in run-flat mode depends on the load in the vehicle. You can drive 50 miles (80 km) if the vehicle is partially laden and 18 miles (30 km) if it is fully laden.

The maximum permissible distance which can be driven in run-flat mode is counted from the moment the tire pressure loss warning appears in the multifunction display.

You must not exceed a maximum speed of 50 mph (80 km/h).

⚠ WARNING

The handling characteristics of your vehicle deteriorate in run-flat mode, for example:

- when cornering
- when braking
- when accelerating rapidly

Adapt your driving style accordingly and avoid sudden changes in direction and sudden acceleration, as well as driving over obstacles (i.e. curbs, potholes), and driving off-road. This is particularly the case when the vehicle is heavily laden.

The maximum permissible distance that can be driven in run-flat mode depends to a large extent on the loads placed on the vehicle. It can be shorter due to high speeds, a heavy load, sudden changes in direction, the road surface condition, outside temperature, etc., or further if you drive carefully and conservatively.

Do not continue to drive in run-flat mode if:

- you hear banging noises.
- the vehicle starts to shake.
- you see smoke and smell rubber.
- ESP® is intervening constantly.
- there are tears in the sidewalls of the tire.

After driving in run-flat mode, you must have the wheel(s) checked for damage at a qualified specialist workshop which has the necessary specialist knowledge and tools to carry out the work required. The defective tire must be replaced in every case.

Mercedes-Benz recommends that you use an authorized Mercedes-Benz Center for this purpose. In particular, work relevant to safety or on safety-related systems must be carried out at a qualified specialist workshop.

- i** When replacing one or all tires, make sure that you only use tires marked MOExtended and of the specified size for the vehicle.
- i** Vehicles equipped with MOExtended tires are not equipped with a TIREFIT kit at the

factory. It is therefore recommended that you additionally equip your vehicle with a TIREFIT kit if you mount tires that do not feature run-flat properties, e.g. winter tires. A TIREFIT kit can be obtained from an authorized Mercedes-Benz Center.

Battery**Important safety notes**

In order for the battery to achieve the maximum possible service life, it must always be sufficiently charged.

- !** Have the battery checked regularly at a qualified specialist workshop, such as an authorized Mercedes-Benz Center.

Adhere to the service intervals indicated in the service booklet or ask a qualified specialist workshop, such as an authorized Mercedes-Benz Center.

Have the battery charge checked more frequently if you use the vehicle mainly for short trips or if you leave it standing idle for a lengthy period.

Only replace a battery with a battery that has been recommended by Mercedes-Benz.

Consult an authorized Mercedes-Benz Center if you wish to leave your vehicle parked for a long period of time.

⚠ WARNING

Comply with safety precautions and take protective measures when handling batteries.



Risk of explosion



Fire, naked flames and smoking are prohibited when handling the battery. Avoid creating sparks.



Battery acid is caustic. Avoid contact with the skin, eyes or clothing.

Wear suitable protective clothing, in particular gloves, an apron and a face mask.

Immediately rinse acid splashes off with clean water. Consult a doctor if necessary.

Wear eye protection.



Keep children away.



Observe this Operator's Manual.



flush affected area with water and seek medical help if necessary.

A battery will also produce hydrogen gas, which is flammable and explosive. Keep flames or sparks away from battery, avoid improper connection of jumper cables, smoking etc.

WARNING

Do not place any metal objects on the battery as this could result in a short circuit.

Use leak-proof batteries only to avoid the risk of acid burns in the event of an accident.

Take care that you do not become statically charged, e.g. by wearing synthetic clothing or rubbing against textiles. For this reason, you also should not pull or push the battery over carpets or other synthetic materials.

Never touch the battery first. First, touch the outside body of the vehicle in order to release any possible electrostatic charges.

Do not rub the battery with rags or cloths. The battery could explode if touched due to electrostatic charge or due to spark formation.



Environmental note



Batteries contain dangerous substances. It is against the law to dispose of them with the household rubbish. They must be collected separately and recycled to protect the environment.



Dispose of batteries in an environmentally friendly manner. Return discharged batteries to a qualified specialist workshop, e.g. an authorized Mercedes-Benz Center, or to a special collection point for old batteries.



WARNING

Failure to follow these instructions can result in severe injury or death.

Never lean over batteries while connecting. You might get injured.

Battery fluid contains sulfuric acid. Do not allow this fluid to come in contact with eyes, skin or clothing. In case it does, immediately

! Before working on the battery, e.g. loosening the battery terminals, switch off the engine and remove the SmartKey from the ignition. On vehicles with KEYLESS-GO, make sure that the ignition is switched off. Check that all the indicator lamps in the instrument cluster are off. You may otherwise destroy electronic components, such as the alternator.

! Like other batteries, the vehicle battery may discharge over time if you do not use the vehicle. In this case have the battery checked at a qualified specialist workshop, such as an authorized Mercedes-Benz Center. You can also charge the battery with a charger recommended by Mercedes-Benz. Contact an authorized Mercedes-Benz Center for more information.

The battery and the cover of the positive terminal clamp must be installed securely during operation.

- i** Remove the SmartKey if you park the vehicle and do not require any electrical consumers. The vehicle will then use very little energy, thus conserving battery power.

Mercedes-Benz recommends that you do not carry out work on batteries yourself, e.g. removing or charging. Always have this work performed at a qualified specialist workshop, e.g. an authorized Mercedes-Benz Center.

- i** If the power supply has been interrupted, e.g. if the battery has been reconnected, you must carry out the following tasks:

- set the clock (▷ page 206).
On vehicles with COMAND and a navigation system, the clock is set automatically.
- reset the sliding sunroof (▷ page 90).
- reset the panorama roof with power tilt/sliding panel (▷ page 92).
- reset the function for automatically folding the exterior mirrors in/out by folding the mirrors out once (▷ page 110).
- reset the side windows (▷ page 89).

Charging the battery

WARNING

Never charge a battery still installed in the vehicle unless a battery charger unit approved by Mercedes-Benz is being used. Gases may escape during charging and cause explosions that may result in paint damage, corrosion or personal injury.

A battery charger unit specially adapted for Mercedes-Benz vehicles and tested and approved by Mercedes-Benz is available as an accessory. It permits the charging of the battery in its installed position. Contact an

authorized Mercedes-Benz Center for further information and availability.

Charge the battery in accordance with the separate instructions for the battery charger.

WARNING

There is a risk of acid burns during the charging process due to the gases which escape from the battery. Do not lean over the battery during the charging process.

WARNING

Battery acid is caustic. Avoid contact with the skin, eyes or clothing.

- !** Only charge the installed battery with a battery charger which has been tested and approved by Mercedes-Benz. These battery chargers allow the battery to be charged while still installed.
- !** Only use battery chargers with a maximum charging voltage of 14.8 V.
- !** Only charge the battery using the jump-starting connection point.

The jump-starting connection point is in the engine compartment (▷ page 313).

- ▶ Open the hood (▷ page 282).
- ▶ Connect the battery charger to the positive terminal and earth point in the same order as when connecting the donor battery in the jump-starting procedure (▷ page 313).
- ▶ Read the battery charger's operating instructions before charging the battery.

Jump-starting

WARNING

Failure to follow these directions will cause damage to the electronic components, and can lead to a battery explosion and severe injury or death.

Never lean over batteries while connecting or jump starting. You might get injured.

Battery fluid contains sulfuric acid. Do not allow this fluid to come in contact with eyes, skin or clothing. In case it does, immediately flush affected area with water, and seek medical help if necessary.

A battery will also produce hydrogen gas, which is flammable and explosive. Keep flames or sparks away from battery, avoid improper connection of jumper cables, smoking, etc.

Attempting to jump start a frozen battery can result in it exploding, causing personal injury.

Read all instructions before proceeding.

! Avoid repeated and lengthy starting attempts. Otherwise, non-combusted fuel may damage the catalytic converter³⁶ and create a risk of fire.

Do not use a rapid-charging device to start the engine.

Make sure the jumper cables are not damaged.

Make sure the jumper cables are not touching any other metal objects when they are connected to the battery.

If your vehicle's battery is discharged, the engine can be jump-started from another vehicle or from a second battery using jumper cables.

Observe the following points:

- ▶ The battery is not accessible in all vehicles. If the other vehicle's battery is not accessible, jump-start the vehicle using a second battery or a jump-starting device.
 - ▶ Only jump-start the vehicle when the engine is cold and the catalytic converter system has cooled down³⁷.
 - ▶ Do not start the engine if the battery is frozen. Let the battery thaw first.
 - ▶ Jump-starting may only be performed from batteries with a nominal voltage of 12 V.
 - ▶ Only use jumper cables which have a sufficient cross-section and insulated terminal clamps.
 - ▶ Make sure that the jumper cables cannot come into contact with parts, such as the pulley or the fan. These parts move when the engine is started and while it is running.
 - ▶ If the battery is fully discharged, leave the battery that is being used to jump-start connected for a few minutes before attempting to start. This charges the empty battery a little.
- i** Jumper cables and further information about jump-starting can be obtained from any authorized Mercedes-Benz Center, for example.
- ▶ Make sure that the two vehicles do not touch.
 - ▶ Apply the parking brake firmly.
 - ▶ Shift the transmission to position **P**.

³⁶ Only vehicles with a gasoline engine.

³⁷ Only vehicles with a gasoline engine.

- ▶ Switch off all electrical consumers (e.g. radio, blower, etc.).
- ▶ Open the hood (▷ page 282).

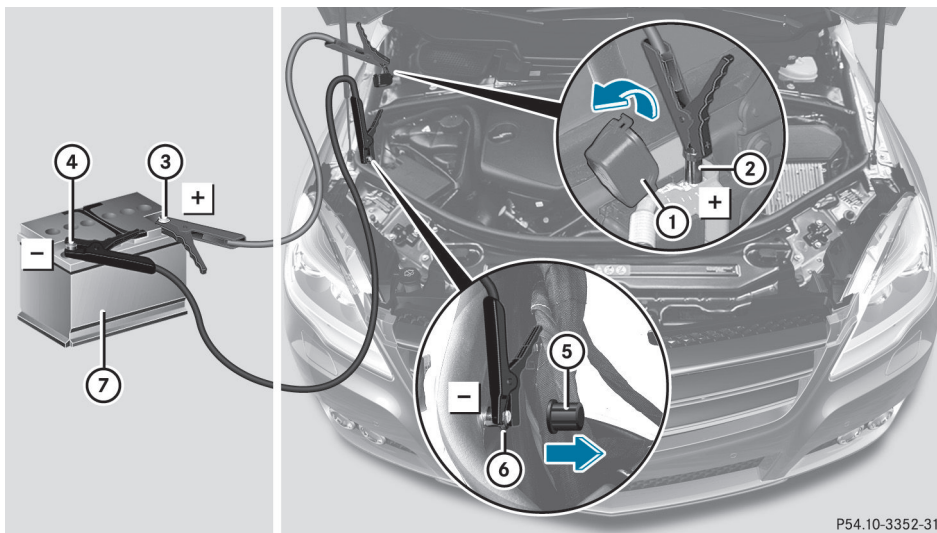

P54.10-3352-31

Breakdown assistance

Position number ⑦ identifies the charged battery of the other vehicle or an equivalent jump-starting device.

- ▶ Lift up cover ① of positive terminal ② in the direction of the arrow.
- ▶ Connect positive terminal ② on your vehicle to positive terminal ③ of donor battery ⑦ using the jumper cable, beginning with your own battery.
- ▶ Start the engine of the donor vehicle and run it at idling speed.
- ▶ Remove cover ⑤ from earth point ⑥.
- ▶ Connect negative terminal ④ of donor battery ⑦ to earth point ⑥ of your vehicle using the jumper cable, connecting the jumper cable to donor battery ⑦ first.
- ▶ Start the engine.
- ▶ Allow the engine to run for a few minutes before disconnecting the jumper cable.
- ▶ First, remove the jumper cable from earth point ⑥ and negative terminal ④, then from positive terminal ② and positive terminal ③, each time disconnecting from the contacts on your own vehicle first.
- ▶ Have the battery checked at a qualified specialist workshop, e.g. an authorized Mercedes-Benz Center. The jump-starting procedure is not a standard operating state; therefore, have the battery checked.

Towing and tow-starting

Important safety notes

WARNING

If you tow the vehicle, you must use a rigid towing bar if:

- the engine is not running.
- there is a brake system malfunction.
- there is a malfunction in the power supply or the vehicle's electrical system.

The power assistance for the steering and the brake force booster do not work when the engine is not running. You will need more force to steer and brake, you may have to depress the brake pedal with maximum force.

Before towing away, make sure that the steering can be moved and is not locked.

If you tow or tow-start another vehicle, its weight must not exceed the maximum permissible gross vehicle weight of your vehicle.

It is better to have the vehicle transported than to have it towed.

! You may only tow the vehicle a maximum distance of 30 miles (50 km). A towing speed of 30 mph (50 km/h) must not be exceeded.

For towing distances over 30 miles (50 km), the vehicle must be loaded onto a transporter.

! Only secure the tow rope or tow bar at the towing eyes. Otherwise, the vehicle could be damaged.

! Do not use the towing eye for recovery, as this could damage the vehicle. If in doubt, recover the vehicle with a crane.

! When towing, pull away slowly and smoothly. If the tractive power is too high, the vehicles could be damaged.

! Do not tow with sling-type equipment. This could damage the vehicle.

! When towing vehicles with KEYLESS-GO, use the key instead of the Start/Stop button. Otherwise, the automatic transmission may shift to position **P** when the driver's or front-passenger door are opened, which could lead to damage to the transmission.

! Vehicles with 4MATIC must not be towed with either the front or the rear axle raised, as doing so will damage the transmission.

If the vehicle has suffered transmission damage, have it transported on a transporter or trailer.

The automatic transmission must be in position **N** when the vehicle is being towed. The battery must be connected and charged. Otherwise, you:

- cannot turn the SmartKey to position **2** in the ignition lock
- cannot shift the automatic transmission to position **N**

i Before the vehicle is towed, switch off the automatic locking feature (▷ page 208). You could otherwise be locked out when pushing or towing the vehicle.

Installing/removing the towing eye

Installing the towing eye

Vehicles with a trailer tow hitch: if possible secure the towing device on the trailer tow hitch (▷ page 191).

► Remove the towing eye from the vehicle tool kit (▷ page 296).

WARNING

The exhaust tail pipe may be hot. You could burn yourself if you touch the tail pipe. Be particularly careful when removing the rear cover.

The mountings for the removable towing eyes are located in the bumpers. They are at the front and at the rear, under the covers.

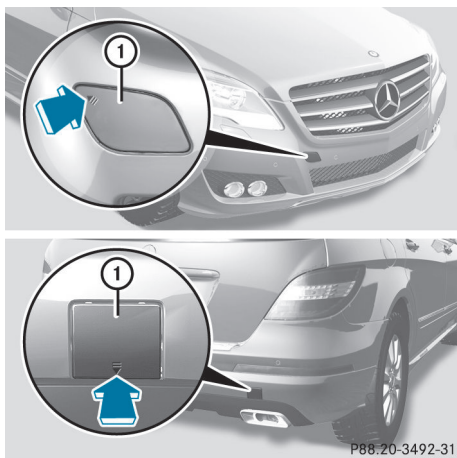

- ▶ Press the mark on cover ① inwards in the direction of the arrow.
- ▶ Take cover ① off the opening.
- ▶ Screw the towing eye in clockwise to the stop and tighten it.

Removing the towing eye

- ▶ Loosen the towing eye and unscrew it.
- ▶ Attach cover ① to the bumper and press until it engages.
- ▶ Place the towing eye in the vehicle tool kit.

Towing a vehicle with both axles on the ground

When having your vehicle towed, observe the important safety notes (▷ page 315).

WARNING

The power assistance for the steering and the brake force booster do not work when the engine is not running. You will then need much more effort to brake and steer the vehicle. Adapt your style of driving accordingly.

The automatic transmission automatically shifts to position **P** when you open the driver's or front-passenger door or when you remove the SmartKey from the ignition lock. In order to ensure that the automatic transmission stays in position **N** when towing the vehicle, you must observe the following points:

- ▶ Make sure that the vehicle is stationary and the SmartKey in the ignition lock is in position **0**.
- ▶ Turn the SmartKey to position **2** in the ignition lock.
On vehicles with KEYLESS-GO, use the key instead of the Start/Stop button (▷ page 145).
- ▶ Depress and hold the brake pedal.
- ▶ Shift the automatic transmission to position **N**.
- ▶ Release the brake pedal.
- ▶ Release the parking brake.
- ▶ Leave the SmartKey in position **2** in the ignition lock.

Transporting the vehicle

The towing eyes or trailer tow hitch can be used to pull the vehicle onto a trailer or transporter if you wish to transport it.

- ▶ Turn the SmartKey to position **2** in the ignition lock.
- ▶ Shift the automatic transmission to position **N**.

As soon as the vehicle is loaded:

- ▶ Prevent the vehicle from rolling away by applying the parking brake.
- ▶ Shift the automatic transmission to position **P**.
- ▶ Turn the SmartKey to position **0** in the ignition lock and remove the SmartKey from the ignition lock.
- ▶ Secure the vehicle.

 Only lash the vehicle down by the wheels or wheel rims, not by parts of the vehicle

such as axle or steering components. Otherwise, the vehicle could be damaged.

Notes for 4MATIC vehicles

! Vehicles with 4MATIC must not be towed with either the front or the rear axle raised, as doing so will damage the transmission.

If the vehicle has transmission damage or damage to the front or rear axle, have it transported on a transporter or trailer.

In the event of damage to the electrical system

If the battery is defective, the automatic transmission will be locked in position **P**. To shift the automatic transmission to position **N**, you must provide power to the vehicle's electrical system in the same way as when jump-starting (▷ page 313).

Have the vehicle transported on a transporter or trailer.

Recovering a vehicle that has become stuck

! Pull away smoothly, slowly, and in a straight line when pulling out a vehicle that has become stuck. Excessive tractive power could damage the vehicles.

If the drive wheels have become stuck in loose or muddy ground, pull the vehicle out with extreme caution, particularly if it is laden.

Never attempt to recover a stuck vehicle with a trailer attached.

Pull out the vehicle backwards, if possible using the tracks it made when it became stuck.

Tow-starting (emergency engine starting)

! Vehicles with automatic transmission must not be started by tow-starting. This could otherwise damage the transmission.

Fuses

Important safety notes

The fuses in your vehicle serve to close down faulty circuits. If a fuse blows, all the components on the circuit and their functions stop operating.

WARNING

Only use fuses approved by Mercedes-Benz with the specified amperage for the system in question and do not attempt to repair or bridge a blown fuse. Using other than approved fuses or using repaired or bridged fuses may cause an overload leading to a fire, and/or cause damage to electrical components and/or systems. Have the cause determined and remedied by an authorized Mercedes-Benz Center.

Blown fuses must be replaced with fuses of the same rating, which you can recognize by the color and value. The fuse ratings are listed in the fuse allocation chart. An authorized Mercedes-Benz Center will be happy to advise you.

i If a fuse has blown, contact a breakdown service or an authorized Mercedes-Benz Center.

If the newly inserted fuse also blows, have the cause traced and rectified at a qualified specialist workshop, e.g. an authorized Mercedes-Benz Center.

! Only use fuses that have been approved for Mercedes-Benz vehicles and which have the correct fuse rating for the system concerned. Otherwise, components or systems could be damaged.

Before changing a fuse

- ▶ Park the vehicle and apply the parking brake.
- ▶ Switch off all electrical consumers.
- ▶ Remove the SmartKey from the ignition lock.

The fuses are located in various fuse boxes:

- fuse box on the front-passenger side of the dashboard
- fuse box in the engine compartment on the right-hand side of the vehicle, when viewed in the direction of travel
- fuse box in the stowage well under the trunk floor

The fuse allocation chart is located in the vehicle tool kit (▷ page 296) in the stowage compartment under the trunk floor.

Breakdown assistance

Dashboard fuse box

- ❗ Do not use a pointed object such as a screwdriver to open the cover in the dashboard. You could damage the dashboard or the cover.

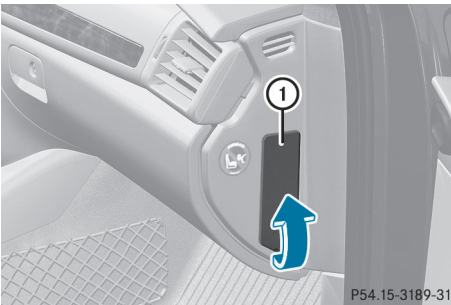

- ▶ **To open:** pull cover ① upwards in the direction of the arrow and remove it.
- ▶ **To close:** clip in cover ① on top of the dashboard.
- ▶ Fold cover ① inwards until it engages.

Fuse box in the engine compartment

- ▶ Open the hood (▷ page 282).

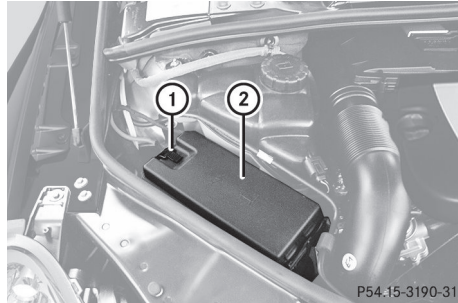

- ▶ Remove any existing moisture from the fuse box using a dry cloth.
- ▶ **To open:** open clamp ①.
- ▶ Fold up cover ② and remove it.
- ❗ Make sure that no moisture can enter the fuse box when the cover is open.
- ▶ **To close:** check whether the seal is lying correctly in cover ②.
- ▶ Insert cover ② into the retainer at the front of the fuse box.
- ▶ Fold down cover ② and close clamp ①.
- ❗ The cover must be positioned properly. Moisture or dirt could otherwise impair the operation of the fuses.
- ▶ Close the hood (▷ page 283).

Fuse box in the cargo compartment

- ▶ Open the tailgate.

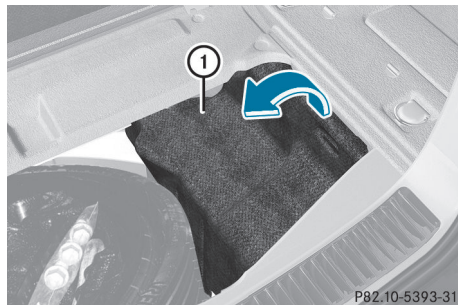

- ▶ **To open:** open the trunk floor and secure it (▷ page 296).
- ▶ Fold cover ① to the left in the direction of the arrow.

Engine emergency off

If the engine cannot be switched off as described, observe the following procedure:

- ▶ Take the fuse allocation chart out of the vehicle tool kit (▷ page 296).
- ▶ Search for fuse 120 in the fuse allocation chart.
- ▶ Open the fuse box in the engine compartment (▷ page 318).
- ▶ Remove fuse 120.

Useful information	322
Important safety notes	322
Operation	322
Winter operation	324
Tire pressure	325
Loading the vehicle	333
Maximum load rating	337
Uniform Tire Quality Grading Standards	338
Tire labeling	339
Definition of terms for tires and loading	343
Changing a wheel	346
Wheel and tire combinations	347

Useful information

- i** This Operator's Manual describes all models and all standard and optional equipment of your vehicle available at the time of publication of the Operator's Manual. Country-specific differences are possible. Please note that your vehicle may not be equipped with all features described. This also applies to safety-related systems and functions.
- i** Please read the information on qualified specialist workshops (▷ page 24).

Important safety notes

Consult an authorized Mercedes-Benz Center if you require information on approved and recommended tires and wheels for summer and winter operation. Advice on purchasing and caring for tires is also available there.

WARNING

Replace rims or tires with the same designation, manufacturer and type as shown on the original part. For further information contact an authorized Mercedes-Benz Center. If incorrectly sized rims and tires are mounted, the wheel brakes or suspension components can be damaged. Also, the operating clearance of the wheels and the tires may no longer be correct.

WARNING

Worn, old tires can cause accidents. If the tire tread is worn to minimum tread depth, or if the tires have sustained damage, replace them.

When replacing rims, only use genuine Mercedes-Benz wheel bolts specified for the particular rim type. Failure to do so can result in the bolts loosening and possibly an accident.

Retreaded tires are not tested or recommended by Mercedes-Benz, since previous damage cannot always be

recognized on retreads. The operating safety of the vehicle cannot be assured when such tires are used.

WARNING

If you feel a sudden significant vibration or ride disturbance, or you suspect that possible damage to your vehicle has occurred, you should turn on the hazard warning flashers, carefully slow down, and drive with caution to an area which is a safe distance from the road.

Inspect the tires and the vehicle underbody for possible damage. If the vehicle appears unsafe, have the vehicle towed to the nearest authorized Mercedes-Benz Center or tire dealer for repairs.

WARNING

Do not drive with a flat tire. A flat tire affects the ability to steer or brake the vehicle. You might lose control of the vehicle. Continued driving with a flat tire or driving at high speed with a flat tire will cause excessive heat build-up and possibly a fire.

- i** Further information about Tires and wheels can be obtained from any authorized Mercedes-Benz Center.

Operation

Notes on driving

- If the vehicle is heavily laden, check the tire pressures and correct them if necessary.
- When parking your vehicle, make sure that the tires do not get deformed by the curb or other obstacles. If it is necessary to drive over curbs, speed humps or similar elevations, try to do so slowly and at an obtuse angle. Otherwise, the tires, particularly the sidewalls, can get damaged.

Notes on regularly inspecting wheels and tires

WARNING

Regularly check the tires for damage. Damaged tires can cause tire inflation pressure loss. As a result, you could lose control of your vehicle.

Worn, old tires can cause accidents. If the tire tread is worn to minimum tread depth, or if the tires have sustained damage, replace them.

- Regularly check the wheels and tires of your vehicle for damage (e.g. cuts, punctures, tears, bulges on tires and deformation or cracks or severe corrosion on wheels) at least once a month, as well as after driving off-road or on rough roads. Damaged wheels can cause a loss of tire pressure.
- Regularly check the tire tread depth and the condition of the tread across the whole width of the tire (▷ page 323). If necessary, turn the front wheels to full lock in order to inspect the inner side of the tire surface.
- All wheels must have a valve cap to protect the valve against dirt and moisture. Do not mount anything onto the valve (such as tire pressure monitoring systems) other than the standard valve cap or other valve caps approved by Mercedes-Benz for your vehicle.
- Regularly check the pressure of all the tires including the emergency spare wheel or the spare wheel, particularly prior to long trips, and correct the pressure as necessary (▷ page 325).

Tire tread

WARNING

Although the applicable federal motor vehicle safety laws consider a tire to be worn when the tread wear indicators (TWI) become visible at approximately $1/16$ in (1.6 mm), we

recommend that you do not allow your tires to wear down to that level. As tread depth approaches $1/8$ in (3 mm), the adhesion properties on a wet road are sharply reduced. Depending upon the weather and/or road surface (conditions), the tire traction varies widely.

Do not use tires that are excessively worn as the tire traction on wet road surfaces decreases significantly when the tread depth is less than $1/8$ inch (3 mm).

Tread wear indicators (TWI) are required by law. Six indicators are positioned over the tire tread. They are visible as soon as a tread depth of approx. $1/16$ inch (1.6 mm) is reached. If this is the case, the tire is so worn that it must be replaced.

The recommended tread depth for summer tires is at least $1/8$ inch (3 mm). The recommended tread depth for winter tires is at least $1/6$ inch (4 mm).

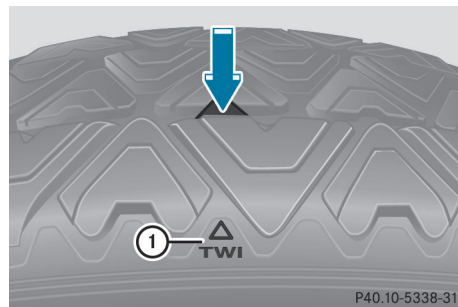

Bar marking ① for tread wear is integrated into the tire tread.

Notes on selecting, mounting and replacing tires

- Only mount tires and wheels of the same type and make.
- Only mount tires of the correct size onto the wheels.
- After mounting new tires, run them in at moderate speeds for the first 60 miles

(100 km) as they only reach their full performance after this distance.

- Do not use tires that are excessively worn as the tire traction on wet road surfaces decreases significantly when the tread depth is less than $\frac{1}{8}$ inch (3 mm).
- Replace the tires after six years at the latest, regardless of wear. This also applies to the emergency spare wheel/spare wheel.

The service life of tires depends on the following factors amongst other things:

- driving style
- tire pressure
- mileage

Wheels and tires

MOExtended tires (tires with run-flat properties)

MOExtended tires (tires with run-flat properties) allow you to continue driving your vehicle even if one or more tires are entirely deflated.

MOExtended tires may be used only in conjunction with the activated tire pressure loss warning system or the activated tire pressure monitoring system and only on wheels specifically tested by Mercedes-Benz.

- **i** Vehicles equipped with MOExtended tires are not equipped with a TIREFIT kit at the factory. It is therefore recommended that you additionally equip your vehicle with a TIREFIT kit if you mount tires that do not feature run-flat properties, e.g. winter tires. A TIREFIT kit can be obtained from an authorized Mercedes-Benz Center.

You will find notes on driving with a flat tire in the "Breakdown assistance" section (▷ page 309).

Winter operation

Please bear the following in mind

At the onset of winter, have your vehicle winterproofed at a qualified specialist workshop, e.g. at an authorized Mercedes-Benz Center.

Observe the notes in the "Changing a wheel" section (▷ page 346).

Driving with summer tires

At temperatures below 45 °F (+7 °C), the elasticity of summer tires and therefore also traction and braking capability are reduced considerably – equip your vehicle with M+S tires. Using summer tires at very cold temperatures could cause tears to form, thereby damaging the tires permanently. Mercedes-Benz cannot accept responsibility for this type of damage.

M+S tires

At temperatures below 45 °F(+7 °C), use winter tires or all-season tires. Both types of tire are identified by the M+S marking.

Only winter tires bearing the  snowflake symbol in addition to the M+S marking provide the best possible grip in wintry road conditions. Only these tires will allow driving safety systems such as ABS and ESP® to function optimally in winter, as these tires have been designed specifically for driving on snow.

Use M+S tires of the same make and tread on all wheels to maintain safe handling characteristics.

WARNING

M+S tires with a tread depth of less than $\frac{1}{6}$ inch (4 mm) must be replaced immediately. They are no longer suitable for use in winter.

Always observe the maximum permissible speed specified for the M+S tires you have mounted.

Once you have mounted the winter tires:

- ▶ Check the tire pressures (▷ page 329).
- ▶ Restart the tire pressure monitor (▷ page 331).

WARNING

If you use your spare wheel when M+S tires are mounted on the other wheels, be aware that the difference in tire characteristics impairs cornering ability and reduces driving stability. Adapt your driving style accordingly.

Have the spare wheel replaced by a normal wheel with an M+S tire at the nearest Mercedes-Benz Center.

Snow chains

For safety reasons, Mercedes-Benz recommends that you only use snow chains which have been specially approved for your vehicle by Mercedes-Benz, or are of a corresponding standard of quality.

! Vehicles with the Adaptive Damping System (ADS): do not drive in ADS SPORT mode if snow chains have been mounted. The vehicle may otherwise be damaged.

! There is not enough space for snow chains on some wheel sizes. Observe the information under "Tires and wheels" in the "Technical Data" section to avoid damage to the vehicle or the wheels.

- Only use snow chains when driving on roads completely covered by snow. Do not exceed the maximum permissible speed of 30 mph (50 km/h). Remove the snow chains as soon as possible when you are no longer driving on snow-covered roads.
- Local regulations may restrict the use of snow chains. Applicable regulations must

be observed if you wish to mount snow chains.

- Snow chains must not be mounted on emergency spare wheels.

If you intend to mount snow chains, please bear the following points in mind:

- you may not attach snow chains to all wheel-tire combinations; see the information under "Wheel and tire combinations" in the "Wheels and tires" section.
- mount snow chains only in pairs and only to the rear wheels. Observe the manufacturer's installation instructions.

! If snow chains are mounted on the front wheels, the snow chains could grind against the bodywork or components of the chassis. This could result in damage to the vehicle or the tires.

! **Vehicles with steel wheels:** if you wish to install snow chains to steel wheels, make sure that you remove the respective wheels' hubcaps first. The hubcaps may otherwise be damaged.

i You may wish to deactivate ESP® (▷ page 66) when pulling away with snow chains mounted. This way you can allow the wheels to spin in a controlled manner, achieving an increased driving force (cutting action).

Tire pressure

Tire pressure specifications

WARNING

Follow recommended tire inflation pressures. Do not underinflate tires. Underinflated tires wear excessively and/or unevenly, adversely affect handling and fuel economy, and are more likely to fail from being overheated. Do not overinflate tires. Overinflated tires can adversely affect handling and ride comfort, wear unevenly, increase stopping distance,

and result in sudden deflation (blowout) because they are more likely to become punctured or damaged by road debris, potholes etc.

Do not overload the tires by exceeding the specified load limit as indicated on the Tire and Loading Information placard on the driver's door B-pillar. Overloading the tires can overheat them, possibly causing a blowout. Overloading the tires can also result in handling or steering problems, or brake failure.

You will find a table of recommended tire pressures on the Tire and Loading Information placard on the B-pillar on the driver's side (▷ page 333). You will find a table of tire pressures for various operating conditions on the inside of your vehicle's fuel filler flap.

To test tire pressure, use a suitable tire pressure gauge. The outer appearance of a tire does not permit any reliable conclusion about the tire pressure. On vehicles equipped with the electronic tire pressure monitoring system, the tire pressure can be checked using the on-board computer.

WARNING

Should the tire pressure drop repeatedly:

- check the tire for foreign bodies.
- check whether the wheel is losing air or the valve is leaking.
- make sure that only a valve cap approved by Mercedes-Benz is installed on the tire valve.

Tire pressures that are too low have a negative effect on vehicle safety, which could lead you to cause an accident.

Only correct tire pressures when the tires are cold. The tires are cold when the vehicle has been parked for at least three hours or driven for less than 1 mile (1.6 km). The tire temperature changes depending on the outside temperature, the vehicle speed and the tire load. If the tire temperature changes

by 18 °F (10 °C), the tire pressure changes by approximately 10 kPa (0.1 bar / 1.5 psi). Take this into account when checking the pressure of warm tires and only correct the tire pressure if it is too low for the current operating conditions. If you check the tire pressure when the tires are warm, the resulting value will be higher than if the tires were cold. This is normal. Do not reduce the tire pressure to the value specified for cold tires. The tire pressure would otherwise be too low.

Observe the recommended tire pressure specifications for cold tires on the Tire and Loading Information placard on the B-pillar on the driver's side.

-  The specifications given on the following Tire and Loading Information placard are examples. Tire pressure specifications are vehicle-specific and may deviate from the data shown here. The tire pressures applicable to your vehicle can be found on the Tire and Loading Information placard on your vehicle.

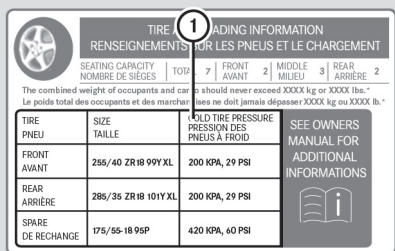

TIRE AND LOADING INFORMATION
RENSEIGNEMENTS POUR LES PNEUS ET LE CHARGEMENT

SEATING CAPACITY / NOMBRE DE SIÈGES: 7
TOTAL: 7 | FRONT / AVANT: 2 | MIDDLE / MILIEU: 3 | REAR / ARRIÈRE: 2

The combined weight of occupants and cargo should never exceed XXXX kg or XXXX lbs.
Le poids total des occupants et des marchandises ne doit jamais dépasser XXXX kg ou XXXX lb.*

TIRE / PNEU	SIZE / TAILLE	COLD TIRE PRESSURE / PRESSION DES PNEUS À FROID	SEE OWNERS MANUAL FOR ADDITIONAL INFORMATION
FRONT / AVANT	255/40 ZR18 99Y XL	200 KPA, 29 PSI	
REAR / ARRIÈRE	285/35 ZR18 101Y XL	200 KPA, 29 PSI	
SPARE / DE RECHANGE	175/55-18 95P	420 KPA, 60 PSI	

P40.00-2133-31

You will find recommended tire pressure specifications  for cold tires and for a fully loaded vehicle on the Tire and Loading Information placard. The tire pressure information is applicable to all tires mounted at the factory.

Important notes on tire pressure

WARNING

If the tire pressure drops repeatedly, check the tires for punctures from foreign objects and/or whether air is leaking from the valves or from around the rim.

The tire temperature and pressure increase when the vehicle is in motion. This is dependent on the driving speed and the load. If you wish to drive at high speeds of 100 mph (160 km/h) or higher when this is allowed, use the tire pressure table on the inside of the fuel filler flap to set the correct tire pressures when the tires are cold. If the tire pressure is not set correctly, this can lead to an excessive build up of heat and a sudden loss of pressure.

For further information, consult a qualified specialist workshop, e.g. an authorized Mercedes-Benz Center.

-  Driving comfort can be impaired if the tire pressure value recommended in the tire pressure table for speeds over 100 mph (160 km/h) is adopted.

Make sure that the tire pressure for normal speeds is adopted again.

Additional specifications of tire pressure values for loads can also be found on the tire pressure table on the inside of the fuel filler flap.

The tire pressure for emergency spare wheels can be found:

- printed in yellow on the rim of the emergency spare wheel
 - in the "Wheel and tire combinations" section (▷ page 347) in this manual
 - on the Tire and Loading Information placard on the B-pillar on the driver's side.
-  Specifications shown in the examples of tire pressure tables are for illustration purposes only. Tire pressure specifications are vehicle-specific and may deviate from the data shown here. Tire pressure

specifications applicable to your vehicle are located in your vehicle's tire pressure table.

Unless stated otherwise, the tire pressures specified on the fuel filler flap apply for all tires approved for this vehicle.

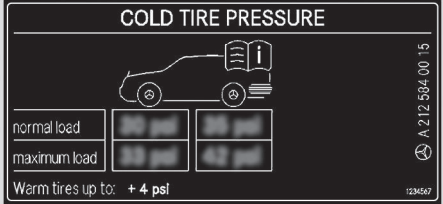

COLD TIRE PRESSURE			
	normal load		
	35 psi	35 psi	
	maximum load		
	35 psi	42 psi	
Warm tires up to: + 4 psi			

P40.00-2179-31

Tire pressure table for all tires permitted for this vehicle by the factory (example)

If a tire size precedes a tire pressure, the tire pressure information following is only valid for that tire size. The load conditions "partially laden" and "fully laden" are defined in the table for different numbers of passengers and amounts of luggage. The actual number of seats may differ.

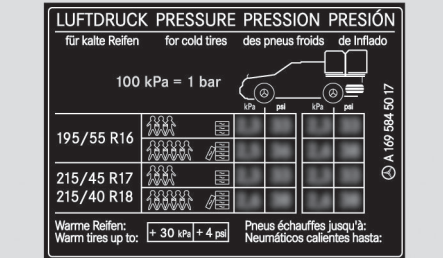

LUFTDRUCK PRESSURE PRESSION PRESSION			
für kalte Reifen for cold tires des pneus froids de Inflado			
100 kPa = 1 bar			
195/55 R16	3.0	3.5	3.5
215/45 R17	3.0	3.5	3.5
215/40 R18	3.0	3.5	3.5
Warme Reifen: Warm tires up to:		+ 30 kPa + 4 psi	
		Pneus échauffés jusqu'à: Neumáticos calientes hasta:	

P40.00-2183-31

Tire pressure table with tire dimensions (example)

Some tire pressure tables show only the rim diameters instead of the full tire size, e.g.

R18. The rim diameter is part of the tire dimension and can be found on the sidewall of the tire (▷ page 340).

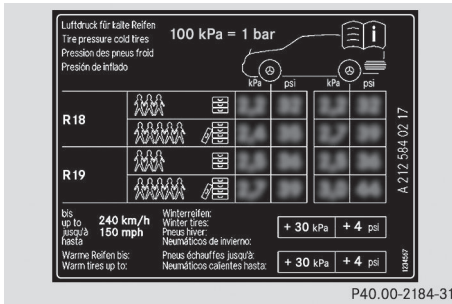

- i** For trailer towing, adjust the tire pressure of the rear tires to the maximum tire pressure value stated on the table inside the fuel filler flap.

Underinflated or overinflated tires

Underinflated tires

⚠ WARNING

Follow recommended tire inflation pressures. Do not underinflate tires. Underinflated tires wear excessively and/or unevenly, adversely affect handling and fuel economy, and are more likely to fail from being overheated.

Underinflated tires can:

- wear excessively and/or unevenly
- adversely affect fuel economy
- fail from being overheated
- adversely affect handling

Overinflated tires

⚠ WARNING

Follow recommended tire inflation pressures. Do not overinflate tires. Overinflated tires can adversely affect handling and ride comfort, wear unevenly, increase stopping distance, and result in sudden deflation (blowout) because they are more likely to become punctured or damaged by road debris, potholes etc.

Overinflated tires can:

- adversely affect handling
- wear excessively and/or unevenly
- be more likely to become damaged
- adversely affect ride comfort
- increase stopping distance

Maximum tire pressure

⚠ WARNING

Never exceed the maximum tire inflation pressure. Follow recommended tire inflation pressures.

Do not underinflate tires. Underinflated tires wear excessively and/or unevenly, adversely affect handling and fuel economy, and are more likely to fail from being overheated.

Do not overinflate tires. Overinflated tires can adversely affect handling and ride comfort, wear unevenly, increase stopping distance, and result in sudden deflation (blowout) because they are more likely to become punctured or damaged by road debris, potholes etc.

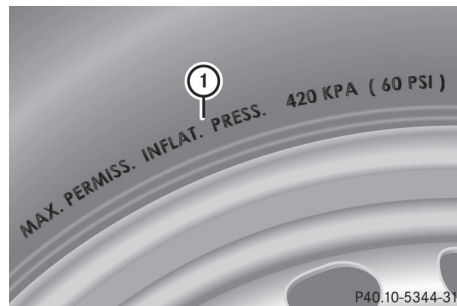

- 1** Maximum permitted tire pressure (example)

- i** The actual values for tires are specific to each vehicle and may deviate from the values in the illustration.

When adjusting the tire pressures always observe the recommended tire pressure for your vehicle (▷ page 325).

Checking the tire pressures

Important safety notes

WARNING

Follow recommended tire inflation pressures.

Do not underinflate tires. Underinflated tires wear excessively and/or unevenly, adversely affect handling and fuel economy, and are more likely to fail from being overheated.

Do not overinflate tires. Overinflated tires can adversely affect handling and ride comfort, wear unevenly, increase stopping distance, and result in sudden deflation (blowout) because they are more likely to become punctured or damaged by road debris, potholes etc.

Do not overload the tires by exceeding the specified load limit as indicated on the Tire and Loading Information placard on the driver's door B-pillar. Overloading the tires can overheat them, possibly causing a blowout. Overloading the tires can also result in handling or steering problems, or brake failure.

Check the tire pressure at least once a month. Only check and correct tire pressures when the tires are cold (▷ page 325).

Checking tire pressure manually

To determine and set the correct tire pressure, proceed as follows:

- ▶ Remove the valve cap of the tire that is to be checked.
- ▶ Press the tire pressure gauge securely onto the valve.
- ▶ Read the tire pressure and compare it with the recommended value on the Tire and Loading Information placard on the B-pillar on the driver's side of your vehicle.
- ▶ If necessary, increase the tire pressure to the recommended value (▷ page 325).
- ▶ If the tire pressure is too high, release air by pressing down the metal pin in the valve using the tip of a pen, for example. Then

check the tire pressure again using the tire pressure gauge.

- ▶ Screw the valve cap onto the valve.
- ▶ Repeat these steps for the other tires.

Tire pressure loss warning system (Canada only)

Important safety notes

While the vehicle is in motion, the tire pressure loss warning system monitors the set tire pressure using the rotational speed of the wheels. This enables the system to detect significant pressure loss in a tire. If the speed of rotation of a wheel changes as a result of a loss of pressure, a corresponding warning message will appear in the multifunction display.

WARNING

When the multifunction display shows the message **Tire Pressure Check Tires**, one or more of your tires are significantly underinflated. You should stop and check your tires as soon as possible, and inflate them to the proper tire inflation pressure as indicated on the vehicle's Tire and Loading Information placard or on the tire inflation pressure label.

Driving on a significantly underinflated tire causes the tire to overheat and can lead to tire failure. Underinflation also reduces fuel efficiency and tire tread life, and may affect the vehicle's handling and stopping ability.

Each tire, including the spare, should be checked at least once a month when cold. Inflate the tires to the recommended tire inflation pressure as specified on

- the Tire and Loading Information placard on the driver's door B-pillar
- or
- the tire inflation pressure label located on the inside of the fuel filler flap

⚠ WARNING

The tire pressure loss warning system does not provide a warning for wrongly selected tire inflation pressures. Always adjust tire inflation pressure according to the Tire and Loading Information placard on the driver's door B-pillar or on the tire inflation pressure label located on the inside of the fuel filler flap.

The tire pressure loss warning system does not replace regular checks of the tire inflation pressures since a gradual pressure loss in more than one tire cannot be detected by the tire pressure loss warning system.

The tire pressure loss warning system is not able to issue a warning due to a sudden dramatic loss of tire inflation pressure (e.g. tire blowout caused by a foreign object). In this case bring the vehicle to a halt by carefully applying the brakes and avoiding abrupt steering maneuvers.

The function of the tire pressure loss warning system is limited or delayed if:

- snow chains are mounted to your vehicle's tires.
- road conditions are wintry.
- you are driving on sand or gravel.
- you adopt a very sporty driving style (cornering at high speeds or driving with high rates of acceleration).
- you are towing a very heavy or large trailer.
- you are driving with a heavy load (in the vehicle or on the roof).

Restarting the tire pressure loss warning system

Restart the tire pressure loss warning system if you have:

- changed the tire pressure
- changed the wheels or tires
- mount new wheels or tires
- ▶ Before restarting, consult the Tire and Loading Information placard on the B-pillar on the driver's side or the tire

pressure table on the inside of the fuel filler flap to ensure the tire pressure in all four tires is set correctly for the current operating conditions.





- ▶ Observe the notes in the section on tire pressures (▷ page 325).

⚠ WARNING

The tire pressure loss warning system can only give reliable warnings if you have set the correct tire pressure.

If an incorrect tire pressure is set, these incorrect values will be monitored.

A tire with insufficient pressure results in vehicle instability when driving, thus increasing the risk of an accident.

- ▶ Make sure that the SmartKey is in position **2** (▷ page 145) in the ignition lock.
- ▶ Press and hold the  or  button on the multifunction steering wheel until the standard display appears in the multifunction display (▷ page 202).
- ▶ Press the  or  button until the **Run Flat Indicator Active Menu: R-Button** message appears in the multifunction display.
- ▶ Press the reset button (▷ page 29) on the instrument cluster.
The **Restart Run Flat Indicator?** message appears in the multifunction display.

If you wish to confirm the restart:

- ▶ Press the  button.
The **Run Flat Indicator Restarted** message appears in the multifunction display.

After a teach-in period, the tire pressure loss warning system will monitor the set tire pressures of all four tires.

If you wish to cancel the restart:

▶ Press the  button.

or

▶ Wait until the **Restart Run Flat Indicator?** message goes out.

The tire pressure values stored at the last restart will continue to be monitored.

Tire pressure monitor (USA only)**Important safety notes**

If a tire pressure monitor system is installed, the vehicle's wheels have sensors that monitor the tire pressures in all four tires. The tire pressure monitor warns you when the pressure drops in one or more of the tires. The tire pressure monitor only functions if the correct wheel electronics units are installed on all wheels.

The tire pressure monitor has a yellow warning lamp in the instrument cluster for indicating pressure loss or a malfunction. Whether the warning lamp flashes or lights up indicates whether a tire pressure is too low or the tire pressure monitoring system is malfunctioning:

- if the warning lamp is lit continuously, the tire pressure on one or more tires is significantly too low. The tire pressure monitor is not malfunctioning.
- if the warning lamp flashes for 60 seconds and then remains lit constantly, the tire pressure monitor is malfunctioning.

 WARNING

Each tire, including the spare (if provided), should be checked at least once a month when cold and inflated to the pressure recommended by the vehicle manufacturer on the tire and Loading Information placard on the driver's door B-pillar or the tire pressure label on the inside of the fuel filler flap. If your vehicle has tires of a different size than the size indicated on the tire and Loading Information placard or the tire pressure label,

you should determine the proper tire pressure for those tires.

As an added safety feature, your vehicle has been equipped with a tire pressure monitoring system (TPMS) that illuminates a low tire pressure telltale when one or more of your tires are significantly underinflated.

Accordingly, when the low tire pressure telltale illuminates, you should stop and check your tires as soon as possible, and inflate them to the proper pressure. Driving on a significantly underinflated tire causes the tire to overheat and can lead to tire failure. Underinflation also reduces fuel efficiency and tire tread life, and may affect the vehicle's handling and stopping ability.

Please note that the TPMS is not a substitute for proper tire maintenance, and it is the driver's responsibility to maintain correct tire pressure, even if underinflation has not reached the level to trigger illumination of the TPMS low tire pressure telltale.

Your vehicle has also been equipped with a TPMS malfunction indicator to indicate when the system is not operating properly. The TPMS malfunction indicator is combined with the low tire pressure telltale. When the system detects a malfunction, the telltale will flash for approximately one minute and then remain continuously illuminated. This sequence will be repeated every time the vehicle is started as long as the malfunction exists.

When the malfunction indicator is illuminated, the system may not be able to detect or signal low tire pressure as intended. TPMS malfunctions may occur for a variety of reasons, including the mounting of incompatible replacement or alternate tires or wheels on the vehicle that prevent the TPMS from functioning properly. Always check the TPMS malfunction telltale after replacing one or more tires or wheels on your vehicle to ensure that the replacement or alternate tires and wheels allow the TPMS to continue to function properly.

- i** If the tire pressure monitor is malfunctioning, it may take more than 10 minutes for the tire pressure warning lamp to inform you of the malfunction by flashing for 60 seconds and then remaining lit.

When the malfunction has been rectified, the tire pressure warning lamp goes out after driving for a few minutes.

Information on tire pressures is displayed in the multifunction display. After a few minutes of driving, the current tire pressure of each tire is shown in the multifunction display.

- i** The tire pressure values indicated by the on-board computer may differ from those measured at a gas station with a pressure gauge. The tire pressures shown by the on-board computer refer to those measured at sea level. At high altitudes, the tire pressure values indicated by a pressure gauge are higher than those shown by the on-board computer. In this case, do not reduce the tire pressures.





- i** The operation of the tire pressure monitor can be affected by interference from radio transmitting equipment (e.g. radio headphones, two-way radios) that may be being operated in or near the vehicle.

- i** This device complies with Part 15 of the FCC Rules. Operation is subject to the following two conditions:

1. This device may not cause harmful interference, and
2. this device must accept any interference received, including interference that may cause undesired operation.

Any unauthorized modification to this device could void the user's authority to operate the equipment.

Checking tire pressure electronically

- ▶ Make sure that the SmartKey is in position **2** (▷ page 145) in the ignition lock.
- ▶ Press and hold the  or  button on the multifunction steering wheel until the standard display appears in the multifunction display (▷ page 202).
- ▶ Press and hold the  or  button until the current tire pressure of each tire is shown in the multifunction display.

If the vehicle has been parked for longer than 20 minutes, the **Tire pressure displayed after driving for several minutes** message appears in the display.

After a teach-in period, the tire pressure monitor automatically recognizes new wheels or new sensors. If a clear allocation of the tire pressure values to the individual wheels is not possible, the **Tire Pressure Monitor Active** message is shown instead of the tire pressure display. The tire pressures are already being monitored.

- i** If a spare wheel/emergency spare wheel is mounted, the system may continue to show the tire pressure of the wheel that has been removed for a few minutes. If this occurs, note that the value displayed for the position where the spare tire is mounted is not the same as the spare wheel/emergency spare wheel's current tire pressure.

Tire pressure monitor warning messages

If the tire pressure monitor detects a significant pressure loss on one or more tires, a warning message is shown in the multifunction display. A warning tone also sounds and the tire pressure warning lamp lights up in the instrument cluster.

Each tire that is affected by a significant loss of pressure is highlighted with a color.

If the **Tire Pressure(s) Please Correct [bar]** message appears in the multifunction display:

- ▶ Check the tire pressure on all four wheels and correct it if necessary.
- ❗ If the wheel positions on the vehicle are interchanged, the tire pressures may be displayed for the wrong positions for a short time. This is rectified after a few minutes of driving, and the tire pressures are displayed for the correct positions.

Restarting the tire pressure monitor



WARNING

It is the driver's responsibility to set the tire pressure to the recommended cold tire pressure. Underinflated tires affect the ability to steer or brake the vehicle. You might lose control over the vehicle.



When you restart the tire pressure monitor, all existing warning messages are deleted and the warning lamps go out. The monitor uses the currently set tire pressures as the reference values for monitoring.

The tire pressure monitor must be restarted when you set the tire pressure to a new value (as a result of changed drive or load characteristics, for example). The tire pressure monitor then monitors the new tire pressure values.

Restart the tire pressure monitor after you have set the tire pressure to the value recommended for the desired driving situation (▶ page 325). Only correct tire pressures on cold tires. Comply with the recommended tire pressures on the tire and loading information table on the B-pillar on the driver's side. Additional tire pressure values for driving at high speeds or with heavy loads can be found in the tire pressure table on the inside of the fuel filler flap.

- ▶ Make sure that the tire pressure is correct on all four wheels.
- ▶ Make sure that the SmartKey is in position **2** in the ignition lock.
- ▶ Press and hold the  or  button on the multifunction steering wheel until the

standard display appears in the multifunction display (▶ page 202).

- ▶ Press and hold the  or  button until the tire pressure of each wheel or the **Tire pressure displayed after driving for a few minutes** message appears.
- ▶ Press the reset button on the instrument cluster (▶ page 29). The **Restart tire pressure monitor?** message appears in the multifunction display.

If you wish to confirm the restart:

- ▶ Press the  button. The **Tire Pressure Monitor Restarted** message appears in the multifunction display.

After driving for a few minutes, the system checks whether the current tire pressures are within the specified range. The new tire pressures are then accepted as reference values and monitored.

If you wish to cancel the restart:

- ▶ Press the  button. The tire pressure values stored at the last restart will continue to be monitored.

Loading the vehicle

Instruction labels for tires and loads

WARNING

Do not overload the tires by exceeding the specified load limit as indicated on the Tire and Loading Information placard on the driver's door B-pillar. Overloading the tires can overheat them, possibly causing a blowout. Overloading the tires can also result in handling or steering problems, or brake failure.

Two instruction labels on your vehicle show the maximum possible load.

- (1) The Tire and Loading Information placard on the B-pillar on the driver's side. The Tire and Loading Information placard shows the maximum permissible number of occupants and the maximum permissible vehicle load. It also contains details of the tire sizes and corresponding pressures for tires mounted at the factory.
- (2) The vehicle identification plate is on the B-pillar on the driver's side. The vehicle identification plate informs you of the gross vehicle weight rating. It is made up of the vehicle weight, all vehicle occupants, the fuel and the cargo. You can also find information about the maximum gross axle weight rating on the front and rear axle.

The maximum gross axle weight rating is the maximum weight that can be carried by one axle (front or rear axle). Never exceed the maximum load or the maximum gross axle weight rating for the front or rear axle.

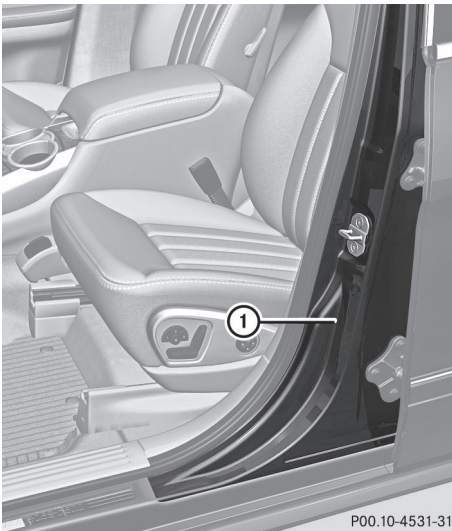

P00.10-4531-31

① B-pillar, driver's side

Maximum permissible gross vehicle weight rating

- ① The specifications shown on the Tire and Loading Information placard in the illustration are examples. The maximum permissible gross vehicle weight rating is vehicle-specific and may differ from that in the illustration. You can find the valid maximum permissible gross vehicle weight rating for your vehicle on the Tire and Loading Information placard.

TIRE AND LOADING INFORMATION RENSEIGNEMENTS POUR LES PNEUS ET LE CHARGEMENT			
SEATING CAPACITY NOMBRE DE SIÈGES	TOT 7	FRONT AVANT 2	MIDDLE MILIEU 3
		REAR ARRIÈRE 2	
The combined weight of occupants and cargo should never exceed XXXX kg or XXXX lbs. Le poids total des occupants et des marchandises ne doit jamais dépasser XXXX kg ou XXXX lb.*			
TIRE PNEU	SIZE TAILLE	COLD TIRE PRESSURE PRESSION DES PNEUS À FROID	SEE OWNERS MANUAL FOR ADDITIONAL INFORMATIONS
FRONT AVANT	285/40 ZR18 99YXL	200 KPA, 29 PSI	
REAR ARRIÈRE	285/35 ZR18 101YXL	200 KPA, 29 PSI	
SPARE DE RECHANGE	175/55-18 95P	420 KPA, 60 PSI	

P40.00-2131-31

- ▶ The Tire and Loading Information placard gives you details on maximum permissible gross vehicle weight rating ①: "The gross weight of occupants and luggage must never exceed XXX kilograms or XXX pounds."

The gross weight of all vehicle occupants, cargo, luggage and trailer load/noseweight (if applicable) must not exceed the specified value.

Number of seats

- ① The specifications shown on the Tire and Loading Information placard in the illustration are examples. The number of seats is vehicle-specific and can differ from the details shown. The number of seats in your vehicle can be found on the Tire and Loading Information placard.

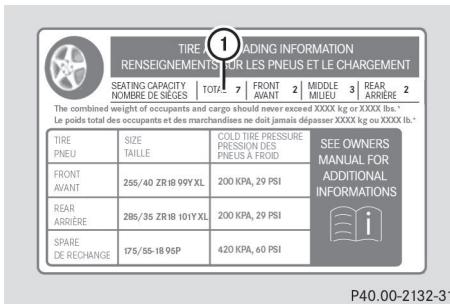

Maximum number of seats ① determines the maximum number of occupants allowed to travel in the vehicle. This information can be found on the Tire and Loading Information placard.

Determining the correct load limit

Step-by-step instructions

The following steps have been developed as required of all manufacturers under Title 49, Code of U.S. Federal Regulations, Part 575 pursuant to the "National Traffic and Motor Vehicle Safety Act of 1966".

- ▶ **Step 1:** Locate the statement "The combined weight of occupants and cargo should never exceed XXX kg or XXX lbs." on your vehicle's Tire and Loading Information placard.
- ▶ **Step 2:** Determine the combined weight of the driver and passengers that will be riding in your vehicle.
- ▶ **Step 3:** Subtract the combined weight of the driver and passengers from XXX kilograms or XXX lbs.
- ▶ **Step 4:** The resulting figure equals the available amount of cargo and luggage load capacity. For example, if the "XXX" amount equals 1400 lbs and there will be five 150 lbs passengers in your vehicle, the amount of available cargo and luggage load capacity is 650 lbs (1400 - 750 (5 x 150) = 650 lbs).

- ▶ **Step 5:** Determine the combined weight of luggage and cargo being loaded on the vehicle. That weight may not safely exceed the available cargo and luggage load capacity calculated in step 4.
- ▶ **Step 6 (if applicable):** If your vehicle will be towing a trailer, load from your trailer will be transferred to your vehicle. Consult this manual to determine how this reduces the available cargo and luggage load capacity of your vehicle (▷ page 337).

Example: step 1 to 3

The following table shows examples on how to calculate total and cargo load capacities with varying seating configurations and number and size of occupants. The following examples use a load limit of 1500 lbs. **This is for illustration purposes only.** Make sure you are using the actual load limit for your vehicle stated on the vehicle's Tire and Loading Information placard (> page 334).

		Example 1	Example 2	Example 3
Step 1	Combined maximum weight of occupants and cargo (data from the Tire and Loading Information placard)	1500 lbs (680 kg)	1500 lbs (680 kg)	1500 lbs (680 kg)

		Example 1	Example 2	Example 3
Step 2	Number of people in the vehicle (driver and occupants)	5	3	1
	Distribution of the occupants	Front: 2 Rear: 3	Front: 1 Rear: 2	Front: 1
	Weight of the occupants	Occupant 1: 150 lbs (68 kg) Occupant 2: 180 lbs (82 kg) Occupant 3: 160 lbs (73 kg) Occupant 4: 140 lbs (63 kg) Occupant 5: 120 lbs (54 kg)	Occupant 1: 200 lbs (91 kg) Occupant 2: 190 lbs (86 kg) Occupant 3: 150 lbs (68 kg)	Occupant 1: 150 lbs (68 kg)
	Gross weight of all occupants	750 lbs (340 kg)	540 lbs (245 kg)	150 lbs (68 kg)

		Example 1	Example 2	Example 3
Step 3	Permissible cargo and trailer load/noseweight (maximum gross vehicle weight rating from the Tire and Loading Information placard minus the gross weight of all occupants)	1500 lbs (680 kg) - 750 lbs (340 kg) = 750 lbs (340 kg)	1500 lbs (680 kg) - 540 lbs (245 kg) = 960 lbs (435 kg)	1500 lbs (680 kg) - 150 lbs (68 kg) = 1350 lbs (612 kg)

The higher the weight of all the occupants, the smaller the maximum load for luggage. Further information can be found under "Towing a trailer" (▷ page 337).

Vehicle identification plate

Even if you have calculated the total load carefully, you should still make sure that the gross vehicle weight rating and the gross axle weight rating are not exceeded. Details can be found on the vehicle identification plate on the B-pillar on the driver's side (▷ page 333).

Gross vehicle weight: the gross weight of the vehicle, all passengers, cargo and trailer load/noseweight (if applicable) must not exceed the permissible gross vehicle weight.

Gross axle weight rating: the maximum permissible load that can be carried by one axle (front or rear axle).

To ensure that your vehicle does not exceed the maximum permissible values (gross vehicle weight and maximum gross axle weight rating), have your loaded vehicle (including driver, occupants, cargo, and full trailer load if applicable) weighed on a suitable vehicle weighbridge.

Trailer load/noseweight

The trailer load/noseweight affects the gross weight of the vehicle. If a trailer is attached, the trailer load/noseweight is included in the load along with occupants and luggage. The trailer load/noseweight is usually between

10% and 15% of the gross weight of the trailer and its cargo.

Maximum load rating

WARNING

Do not overload the tires by exceeding the specified load limit as indicated on the Tire and Loading Information placard on the driver's door B-pillar. Overloading the tires can overheat them, possibly causing a blowout. Overloading the tires can also result in handling or steering problems, or brake failure.



 The actual values for tires are specific to each vehicle and may deviate from the values in the illustration.

Maximum tire load ① is the maximum permitted weight for which the tire is approved.

Further information on tire loads (> page 339).

Uniform Tire Quality Grading Standards

Overview of Tire Quality Grading Standards

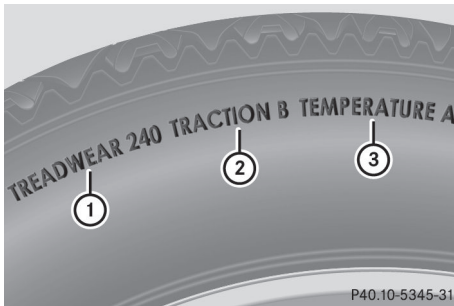

The Uniform Tire Quality Grading is a U.S. Government requirement. Their purpose is to provide drivers with consistent and reliable information regarding tire performance. Tire manufacturers are required to grade tires using three performance factors: tread wear ①, tire traction ②, and temperature resistance ③. Although not a Government of Canada requirement, all tires made for sale in North America have these grades branded on the sidewall.

i The actual values for tires are vehicle-specific and may deviate from the values in the illustration.

Where applicable, the tire grading information can be found on the tire sidewall between the tread shoulder and maximum tire width.

For example:

Tread wear	Traction	Temperature
200	AA	A

All passenger car tires must conform to the statutory safety requirements in addition to these grades.

Tread wear

The tread wear grade is a comparative rating based on the wear rate of the tire when tested under controlled conditions on a specified U.S. government course. For example, a tire graded 150 would wear one and one-half times as well on the government course as a tire graded 100.

The relative performance of tires depends upon the actual conditions of their use, however, and may depart significantly from the norm, due to variations in driving habits, service practices and differences in road characteristics and climate conditions.

Traction

⚠ WARNING

The traction grade assigned to this tire is based on straight-ahead braking traction tests, and does not include acceleration, cornering, hydroplaning, or peak traction characteristics.

The traction grades, from highest to lowest, are AA, A, B, and C. Those grades represent the tire's ability to stop on a wet surface as measured under controlled conditions on specified government test surfaces of asphalt and concrete. A tire marked C may have poor traction performance.

⚠ WARNING

If ice has formed on the road, tire traction will be substantially reduced. Under such weather conditions, drive, steer and brake with extreme caution.

The safe speed on a wet, snow covered or icy road is always lower than on dry road surfaces.

You should pay special attention to road conditions when temperatures are around the freezing point.

Mercedes-Benz recommends a minimum tire tread depth of $\frac{1}{6}$ in (4 mm) for all four winter tires (> page 169) to maintain normal driving characteristics in winter. Winter tires can reduce the braking distance on snow covered surfaces in comparison to summer tires. Stopping distance, however, is still considerably greater than when the road is not covered with ice or snow. Take appropriate care when driving.

! Avoid wheelspin. This can lead to damage to the drive train.

Temperature

! WARNING

The temperature grade for this tire is established for a tire that is properly inflated and not overloaded. Excessive speed, underinflation, or excessive loading, either separately or in combination, can cause excessive heat build-up and possible tire failure.

The temperature grades are A (the highest), B, and C. These represent the tire's resistance to the generation of heat and its ability to dissipate heat when tested under controlled conditions on a specified indoor laboratory test wheel. Sustained high temperature can cause the material of the tire to degenerate and reduce tire life, and excessive temperature can lead to sudden tire failure. The grade C corresponds to a level of performance which all passenger car tires must meet under the Federal Motor Vehicle Safety Standard No. 109. Grades B and A represent higher levels of performance on the laboratory test wheel than the minimum required by law.

Tire labeling

Tire labeling overview

The following markings are on the tire in addition to the tire name (sales designation) and the manufacturer's name:

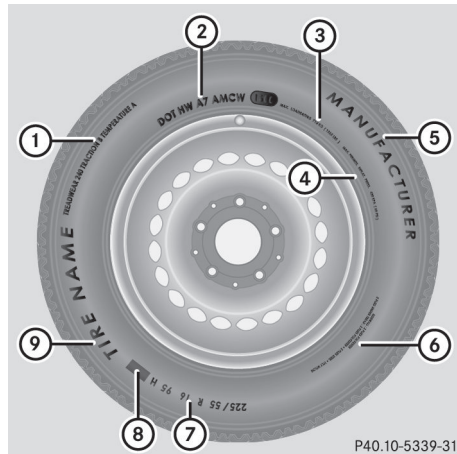

- ① Uniform Tire Quality Grading Standard (> page 343)
 - ② DOT, Tire Identification Number (> page 342)
 - ③ Maximum tire load (> page 337)
 - ④ Maximum tire pressure (> page 328)
 - ⑤ Manufacturer
 - ⑥ Tire material (> page 343)
 - ⑦ Tire size designation, load-bearing capacity and speed index (> page 340)
 - ⑧ Load index (> page 342)
 - ⑨ Tire name
- i** Tire data is vehicle-specific and may deviate from the data in the example.

Tire size designation, load-bearing capacity and speed index

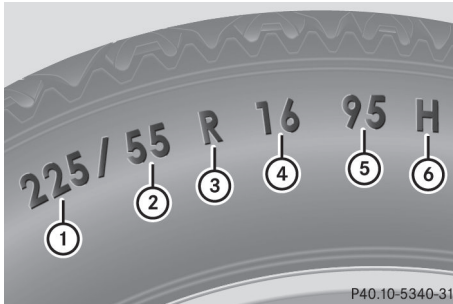

- ① Tire width
- ② Nominal aspect ratio in %
- ③ Tire code
- ④ Rim diameter
- ⑤ Load bearing index
- ⑥ Tire speed rating

i Tire data is vehicle-specific and may deviate from the data in the example.

General: depending on the manufacturer's standards, the size imprinted in the tire wall may not contain any letters or may contain one letter that precedes the size description.

If there is no letter preceding the size description (as shown above): these are passenger vehicle tires according to European manufacturing standards.

If "P" precedes the size description: these are passenger vehicle tires according to U.S. manufacturing standards.

If "LT" precedes the size description: these are light truck tires according to U.S. manufacturing standards.

If "T" precedes the size description: these are compact emergency spare wheels at high tire pressure, to be used only temporarily in an emergency.

Tire width: tire width ① shows the nominal tire width in millimeters.

Nominal aspect ratio: aspect ratio ② is the size ratio between the tire height and the tire width and is shown in percent. The aspect

ratio is calculated by dividing the tire width by the tire height.

Tire code: tire code ③ specifies the tire type. "R" represents radial tires. "D" represents diagonal tires, "B" represents diagonal radial tires.

Optionally, tires with a maximum speed of over 149 mph (240 km/h) may have "ZR" in the size description depending on the manufacturer (e.g. 245/40 ZR 18).

Rim diameter: rim diameter ④ is the diameter of the bead seat, not the diameter of the rim flange. The rim diameter is specified in inches (in).

Load bearing index: load bearing index ⑤ is a numerical code which specifies the maximum load-bearing capacity of a tire.

⚠ WARNING

The tire load rating must always be at least half of the GAWR of your vehicle. Otherwise, sudden tire failure may be the result which could cause an accident and/or serious injury to you or others.

Always replace rims and tires with rims and tires having the same specifications (designation, manufacturer and type) as shown on the original part.

⚠ WARNING

Do not overload the tires by exceeding the specified load limit as indicated on the Tire and Loading Information placard on the driver's door B-pillar. Overloading the tires can overheat them, possibly causing a blowout. Overloading the tires can also result in handling or steering problems, or brake failure.

Example:

The load bearing index 91 is equivalent to a maximum load of 1356 lbs (615 kg) that the tire can carry. For further information on the maximum tire load in kilograms and pounds, see (▷ page 337).

For further information on the load bearing index, see Load index (▷ page 342).

Speed index: speed index ⑥ specifies the approved maximum speed of the tire.

WARNING

Even when permitted by law, never operate a vehicle at speeds greater than the maximum speed rating of the tires.

Exceeding the maximum speed for which tires are rated can lead to sudden tire failure, causing loss of vehicle control and possibly resulting in an accident and/or serious personal injury and possible death, for you and for others.

Regardless of the speed index always observe the speed limits. Drive carefully and adapt your driving style to the traffic conditions.

Summer tires

Index	Speed rating
Q	Up to 100 mph (160 km/h)
R	Up to 106 mph (170 km/h)
S	Up to 112 mph (180 km/h)
T	Up to 118 mph (190 km/h)
H	Up to 130 mph (210 km/h)
V	Up to 149 mph (240 km/h)
W	Up to 168 mph (270 km/h)
Y	Up to 186 mph (300 km/h)
ZR...Y	Up to 186 mph (300 km/h)
ZR...(..Y)	Above 186 mph (300 km/h)
ZR	Above 149 mph (240 km/h)

- Optionally, tires with a maximum speed of over 149 mph (240 km/h) may have "ZR" in the size description depending on the manufacturer (e.g. 245/40 ZR 18).

The service specifications consist of load bearing index ⑤ and speed index ⑥.

- If the size description of your tire includes "ZR" and there are no service specifications, ask the tire manufacturer in order to find out the maximum speed.



If a service specification is available, the maximum speed is limited according to the speed index in the service specification.

Example: 245/40 ZR 18 97 Y. In this example, "97 Y" is the service specification. The letter "Y" represents the speed index and the maximum speed of the tire is limited to 186 mph (300 km/h).

- Every tire that has a maximum speed above 186 mph (300 km/h) must have "ZR" in the size description **and** the service specification must be given in brackets. Example: 275/40 ZR 18 (99 Y). The speed index "(Y)" shows that the maximum speed of the tire is above 186 mph (300 km/h). Ask the tire manufacturer to find out the maximum speed.

All-weather tires and winter tires

Index	Speed rating
Q M+S ³⁸	Up to 100 mph (160 km/h)
T M+S ³⁸	Up to 118 mph (190 km/h)
H M+S ³⁸	Up to 130 mph (210 km/h)
V M+S ³⁸	Up to 149 mph (240 km/h)

-  Not all tires that have the M+S identification offer the driving characteristics of winter tires. Winter tires have, in addition to the M+S identification, the  snowflake symbol on the tire sidewall. Tires with this identification fulfill the requirements of the Rubber Manufacturers Association (RMA) and the Rubber Association of Canada (RAC) regarding the tire traction on snow and

³⁸ Or M+S  for winter tires.

have been especially developed for driving on snow.

An electronic speed limiter prevents your vehicle from exceeding a speed of 130 mph (210 km/h).

The speed index of tires mounted at the factory may be higher than the maximum speed that the electronic speed limiter permits.

Make sure that your tires have the required speed index as specified in the "tires" section (▷ page 347), e.g. if you buy new tires.

Further information about reading tire data can be obtained from any qualified specialist workshop, e.g. an authorized Mercedes-Benz Center.

Load index



i Tire data is vehicle-specific and may deviate from the data in the example.

In addition to the load bearing index, load index ① may be imprinted after the letters that identify speed index ⑥ (▷ page 340) on the sidewall of the tire.

- If no specification is given: no text (as in the example above), represents a standard load (SL) tire
- XL or Extra Load: represents a reinforced tire
- Light load: represents a light load tire
- C, D, E: represents a load range that depends on the maximum load that the tire can carry at a certain pressure

DOT, Tire Identification Number (TIN)

U.S. tire regulations prescribe that every manufacturer of new tires or retreader has to imprint a TIN in or on the sidewall of each tire produced.

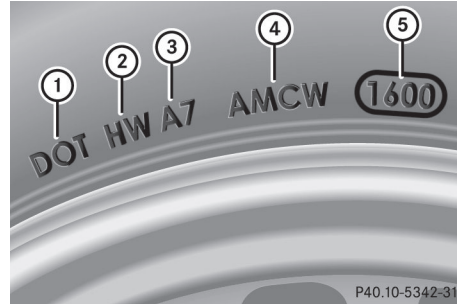

The TIN is a unique identification number. The TIN enables the tire manufacturers to inform purchasers of recalls and other safety-relevant matters. It makes it possible for the purchaser to easily identify the affected tires. The TIN is made up of manufacturer identification code ②, tire size ③, tire type code ④ and manufacturing date ⑤.

i Tire data is vehicle-specific and may deviate from the data in the example.

DOT (Department of Transportation): tire symbol ① indicates that the tire complies with the requirements of the U.S. Department of Transportation.

Manufacturer identification code: manufacturer identification code ② provides details on the tire manufacturer. New tires have a code with two symbols. Retreaded tires have a code with four symbols.

Further information about retreaded tires (▷ page 322).

Tire size: identifier ③ describes the tire size.

Tire type code: tire type code ④ can be used by the manufacturer as a code to describe specific characteristics of the tire.

Date of manufacture: date of manufacture ⑤ provides information about the age of a tire. The first and second positions represent

the week of manufacture, starting with "01" for the first calendar week. Positions three and four represent the year of manufacture. For example, a tire that is marked with "3208", was manufactured in week 32 in 2008.

Tire characteristics

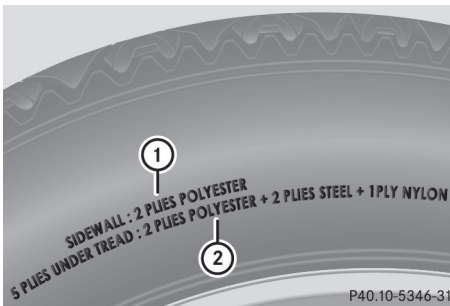

i Tire data is vehicle-specific and may deviate from the data in the example.

This information describes the tire cord and the number of layers in sidewall ① and under the tread ②.

Definition of terms for tires and loading

Tire ply composition and material used

Describes the number of plies or the number of layers of rubber-coated fabric in the tire tread and sidewall. These are made of steel, nylon, polyester and other materials.

Bar

Metric unit for tire pressure. There are 14.5038 pounds per square inch (psi) to 1 bar; there are 100 kilopascals (kPa) to 1 bar.

DOT (Department of Transportation)

DOT marked tires fulfill the requirements of the United States Department of Transportation.

Normal occupant weight

The number of occupants the vehicle is designed to seat, multiplied by 68 kilograms (150 lbs).

Uniform Tire Quality Grading Standards

A uniform standard to grade the quality of tires with regards to tread quality, tire traction and temperature characteristics. Ratings are determined by tire manufacturers using U.S. government testing procedures. The ratings are molded into the sidewall of the tire.

Recommended tire pressure

The recommended tire pressure for your vehicle under normal driving conditions. You will find the recommendation on the Tire and Loading Information placard on the B-pillar on the driver's side of your vehicle. The recommended tire pressure provides the best balance between handling characteristics, ride comfort and wear. Supplemental information pertaining to special driving situations can be found on the tire inflation pressure label on the inside of the fuel filler flap.

Increased vehicle weight due to optional equipment

This is the combined weight of all standard and optional equipment available for the vehicle, regardless of whether it is actually installed on the vehicle or not.

Rim

This is the part of the wheel on which the tire is mounted.

GAWR (Gross Axle Weight Rating)

The GAWR is the maximum permissible axle weight. The actual load on an axle must never exceed the gross axle weight rating. The gross axle weight rating can be found on the vehicle identification plate on the B-pillar on the driver's side.

Tire speed rating

The tire speed rating is part of the tire identification. It specifies the speed range for which the tire is approved.

GTW (Gross Trailer Weight)

The GTW is the weight of a trailer including the weight of the load, luggage, accessories etc. on the trailer.

GVW (Gross Vehicle Weight)

The gross vehicle weight comprises the weight of the vehicle including fuel, tools, the spare wheel, accessories installed, occupants, luggage and the drawbar noseweight if applicable. The gross vehicle weight must not exceed the gross vehicle weight rating GVWR as specified on the vehicle identification plate on the B pillar on the driver's side.

GVWR (Gross Vehicle Weight Rating)

The GVWR is the maximum permissible gross weight of a fully loaded vehicle (the weight of the vehicle including all accessories, occupants, fuel, luggage and the drawbar noseweight if applicable). The gross vehicle weight rating is specified on the vehicle

identification plate on the B-pillar on the driver's side.

Maximum loaded vehicle weight

The maximum weight is the sum of the curb weight of the vehicle, the weight of the accessories, the total load limit and the weight of the optional equipment installed at the factory.

Kilopascal (kPa)

Metric unit for tire pressure. 6.9 kPa is the equivalent of 1 psi. Another unit for tire pressure is bar. There are 100 kilopascals (kPa) to 1 bar.

Load index

In addition to the load bearing index, the load index may also be imprinted on the sidewall of the tire. This specifies the load bearing capacity more precisely.

Curb weight

The weight of a vehicle with standard equipment including the maximum capacity of fuel, oil and coolant. It also includes the air-conditioning system and optional equipment if these are installed in the vehicle, but does not include passengers or luggage.

Maximum load rating

The maximum load rating in kilograms or pounds is the maximum weight for which a tire is approved.

Maximum permissible tire pressure

Maximum permissible tire pressure for one tire.

Maximum load on one tire

Maximum load on one tire. This is calculated by dividing the maximum axle load of one axle by two.

PSI (pounds per square inch)

A standard unit of measure for tire pressure.

Aspect ratio

Relationship between tire height and tire width in percent.

Tire pressure

This is pressure inside the tire applying an outward force to each square inch of the tire's surface. The tire pressure is specified in pounds per square inch (psi), in kilopascal (kPa) or in bar. The tire pressure should only be corrected when the tires are cold. For this, the vehicle must have been stationary for at least three hours or not have traveled more than 1.6 km (1 mile) in this time.

Tire pressure of cold tires

Tire pressure when the vehicle has been stationary for at least three hours or not have traveled more than 1.6 km (1 mile) in this time.

Tread

The part of the tire that comes into contact with the road.

Bead

The tire bead ensures that the tire sits securely on the wheel. There are several steel wires in the bead to prevent the tire from coming loose from the wheel rim.

Sidewall

The part of the tire between the tread and the bead.

Weight of optional extras

The combined weight of those optional extras that weigh more than the replaced standard part and more than 2.3 kilograms (5 lbs). These optional extras, such as high-performance brakes, level control, a roof rack or a high-performance battery, are not included in the curb weight and accessory weight.

TIN (Tire Identification Number)

This is a unique identifier which can be used by a tire manufacturer to identify tires, for example for a product recall, and thus identify the purchasers. The TIN is made up of the manufacturer's identity code, tire size, tire type code and the manufacturing date.

Load bearing index

The load bearing index (also load index) is a code that contains the maximum load bearing capacity of a tire.

Traction

Traction is the result of friction between the tires and the road surface.

TWR (Tongue Weight Rating)

The TWR specifies the maximum permissible weight that the ball coupling of the trailer tow hitch can support.

Treadwear indicators

Narrow bars (tread wear bars) that are distributed over the tire tread. If the tire tread is level with the bars, the wear limit of $\frac{1}{16}$ in (1.6 mm) has been reached.

Occupant distribution

The distribution of occupants in a vehicle at their designated seating positions.

Total load limit

Rated cargo and luggage load plus 68 kilograms (150 lbs) times the vehicle's designated seating capacity.

Changing a wheel

Flat tire

The "Roadside Assistance" section (> page 299) contains information and notes on how to deal with a flat tire. It also provides instructions on changing a wheel or mounting the spare wheel/emergency spare wheel.

Interchanging the wheels

WARNING

Rotate front and rear wheels only if the tires are of the same dimension.

If your vehicle is equipped with mixed-size tires (different tire dimensions front vs. rear), tire rotation is not possible.

WARNING

Have the tightening torque checked after changing a wheel. The wheels could come loose if they are not tightened to a torque of 110 lb-ft (150 Nm).

Only use genuine Mercedes-Benz wheel bolts specified for your vehicle's rims.

The wear patterns on the front and rear tires differ, depending on the operating conditions. Rotate the wheels before a clear wear pattern has formed on the tires. Front tires typically wear more on the shoulders and the rear tires in the center.

If your vehicle's tire configuration allows, you can rotate the wheels according to the intervals in the tire manufacturer's warranty book in your vehicle documents. If this is not available, the tires should then be replaced every 3000 to 6000 miles (5000 to 10,000 km), or earlier if the tire wear requires this. Do not change the direction of wheel rotation.

Clean the contact surfaces of the wheel and the brake disc thoroughly every time a wheel is interchanged. Check the tire pressures.

Information on changing a wheel and mounting the spare wheel (> page 303).

 On vehicles equipped with a tire pressure monitor, electronic components are located in the wheel.

Tire-mounting tools should not be used near the valve. This could damage the electronic components.

Always have the tires changed at a qualified specialist workshop, e.g. an authorized Mercedes-Benz Center.

Direction of rotation

Tires with a specified direction of rotation have additional benefits, e.g. if there is a risk of hydroplaning. You will only gain these benefits if the correct direction of rotation is maintained.

An arrow on the sidewall of the tire indicates its correct direction of rotation.

You may mount a spare wheel/emergency spare wheel against the direction of rotation. Observe the time restriction on use as well as the speed limit specified on the spare wheel/emergency spare wheel.

Storing wheels

Store wheels that are not being used in a cool, dry and preferably dark place. Protect the tires from oil, grease, gasoline and diesel.

Cleaning the wheels

WARNING

Do not use power washers with circular-jet nozzles (dirt grinders) to clean your vehicle, in particular the tires. You could otherwise damage the tires and cause an accident.

Wheel and tire combinations

Please bear the following in mind

! For safety reasons, Mercedes-Benz recommends that you only use Tires and wheels which have been approved by Mercedes-Benz specifically for your vehicle.

These tires have been specially adapted for use with the control systems, such as ABS or ESP®, and are marked as follows:

- MO = Mercedes-Benz Original
- MOE = Mercedes-Benz Original Extended (tires featuring run-flat characteristics)
- MO1 = Mercedes-Benz Original (only certain AMG tires)

Mercedes-Benz Original Extended tires may only be used on wheels that have been specifically approved by Mercedes-Benz. Only use tires, wheels or accessories tested and approved by Mercedes-Benz. Certain characteristics, e.g. handling, vehicle noise emissions or fuel consumption, may otherwise be adversely affected. In addition, when driving with a load, tire dimension variations could cause the tires to come into contact with the bodywork and axle components. This could result in damage to the tires or the vehicle.

Mercedes-Benz accepts no liability for damage resulting from the use of tires, wheels or accessories other than those tested and approved.

Further information about tires, wheels and approved combinations can be obtained from any authorized Mercedes-Benz Center.

- i** The Tire and Load Information placard with the recommended tire pressures is attached to the B-pillar on the driver's side. Further information about driving at high speeds or driving with vehicle loads that are lighter than the maximum vehicle load can be found in the tire pressure table on the inside of the fuel filler flap. Check tire pressures regularly, and only when the tires are cold. Comply with the maintenance recommendations of the tire manufacturer in the vehicle document wallet.

For further information on the recommended tire inflation pressure and on tire pressures for specific driving conditions, see (> page 325).

- i** Notes on the vehicle equipment – always equip the vehicle:
 - with tires of the same size on a given axle (left/right)
 - with the same type of tires at a given time (summer tires, winter tires, MOExtended tires)

- i** Vehicles equipped with MOExtended tires are not equipped with a TIREFIT kit at the factory. It is therefore recommended that you additionally equip your vehicle with a TIREFIT kit if you mount tires that do not feature run-flat properties, e.g. winter tires. A TIREFIT kit can be obtained from an authorized Mercedes-Benz Center.

- i** On the following pages, you can find information on approved wheel rims and tire sizes for equipping your vehicle with winter tires. Winter tires are not available from the factory as standard equipment or optional extras.

If you want to equip your vehicle with approved winter tires, it may be necessary to obtain wheel rims in the corresponding size, as the size of the approved winter tires may differ from the standard tires. This is dependent on the model and the equipment installed at the factory.

The tires and wheel rims, as well as further information, can be obtained at a qualified specialist workshop, e.g. at an authorized Mercedes-Benz Center.





i Overview of abbreviations used in the following tire tables:

- BA: both axles
- FA: front axle
- RA: rear axle

In the following table, the wheel/tire combinations are allocated to the vehicle models through variants, e.g. V1, V2 etc.:

V1	R 350
V2	R 350 BlueTEC

Tires				
	All-weather tires	Alloy wheels	V1	V2
BA	255/50 R19 107 H XL M+S ³⁹	8.0 J x 19 H2 Wheel offset: 2.64 in (67 mm)	•	•
BA	255/50 R19 107 H XL M+S MOExtended ^{40, 41}	8.0 J x 19 H2 Wheel offset: 2.64 in (67 mm)	•	•
BA	255/50 R19 107 H XL M+S	8.5 J x 19 H2 Wheel offset: 2.52 in (64 mm)	•	—
BA	265/45 R20 108 H XL M+S ⁴²	9.0 J x 20 H2 Wheel offset: 2.36 in (60 mm)	•	—

	Winter tires ⁴³	Alloy wheels	V1	V2
BA	255/50 R18 105 H M+S 	8.0 J x 18 H2 Wheel offset: 2.64 in (67 mm)	•	—
BA	255/50 R19 107 H XL M+S  ³⁹	8.0 J x 19 H2 Wheel offset: 2.64 in (67 mm)	•	•
BA	255/50 R19 107 H XL M+S  MOExtended ^{40, 41}	8.0 J x 19 H2 Wheel offset: 2.64 in (67 mm)	•	•
BA	255/50 R19 107 H XL M+S 	8.5 J x 19 H2 Wheel offset: 2.52 in (64 mm)	•	—
BA	265/45 R20 108 H XL M+S  ⁴²	9.0 J x 20 H2 Wheel offset: 2.36 in (60 mm)	•	—

Wheels and tires

Collapsible spare wheel ⁴²				
Tires	Wheels	V1	V2	
T 195/75 - 18 106 P Tire pressure: 300 kPa (3.0 bar/44 psi)	6.5 B x 18 H2 Wheel offset: 1.58 in (40 mm)	•	—	

i The specified tire pressure is printed in yellow on the emergency spare wheel.

³⁹ R 350 BlueTEC: Canada only.

⁴⁰ R 350 BlueTEC: USA only.

⁴¹ MOExtended tires (tires with run-flat characteristics) only in combination with an activated tire pressure loss warning system or tire pressure monitor.

⁴² Use of snow chains is not permitted. Observe the notes in the "Snow chains" section.

⁴³ Not available ex factory.

Useful information	352
Genuine Mercedes-Benz parts	352
Warranty	352
Identification plates	353
Service products and capacities	354
Vehicle data	360

Useful information

- i** This Operator's Manual describes all models and all standard and optional equipment of your vehicle available at the time of publication of the Operator's Manual. Country-specific differences are possible. Please note that your vehicle may not be equipped with all features described. This also applies to safety-related systems and functions.
- i** Please read the information on qualified specialist workshops (▷ page 24).

Genuine Mercedes-Benz parts

All Mercedes-Benz Centers maintain a supply of genuine Mercedes-Benz parts for necessary service and repair work. In addition, strategically located parts delivery centers provide for quick and reliable parts service.

There are more than 300,000 different genuine Mercedes-Benz parts available for Mercedes-Benz models.

Genuine Mercedes-Benz parts are subject to strict quality control. Each part has been specially developed, manufactured or selected for Mercedes-Benz vehicles and fine-tuned for them.

Therefore, only genuine Mercedes-Benz parts should be used.

WARNING

Driving safety may be impaired if non-approved parts, tires and wheels or safety-relevant accessories are used.

This could lead to malfunctions in safety-relevant systems, e.g. the brake system. This could cause you to lose control of your vehicle and cause an accident.

For this reason, Mercedes-Benz recommends that you use genuine Mercedes-Benz parts or parts of equal quality. Only use tires, wheels

and accessories that have been specifically approved for your vehicle.

- !** Air bags and Emergency Tensioning Devices, as well as control units and sensors for these restraint systems may be installed in the following areas of your vehicle:

- doors
- door pillars
- door sills
- seats
- dashboard
- instrument cluster
- center console

Do not install accessories such as audio systems in these areas. Do not carry out repairs or welding. You could impair the operating efficiency of the restraint systems.

Have aftermarket accessories installed at a qualified specialist workshop. Mercedes-Benz recommends that you use an authorized Mercedes-Benz Center for this purpose.

Environmental note

Daimler AG also supplies reconditioned major assemblies and parts which are of the same quality as new parts. They are covered by the same Limited Warranty entitlements as new parts.

Always specify the vehicle identification number (VIN) (▷ page 353) and the engine number (▷ page 354) when ordering genuine Mercedes-Benz parts.

Warranty

The Service and Warranty Information booklet contains detailed information about the warranties covering your vehicle.

Your authorized Mercedes-Benz Center will exchange or repair any defective parts originally installed in the vehicle in accordance with the terms of the following warranties:

- New Vehicle Limited Warranty
- Emission System Warranty
- Emission Performance Warranty
- California, Connecticut, Maine, Massachusetts, New York, Pennsylvania, Rhode Island and Vermont Emission Control Systems Warranty⁴⁴
- State Warranty Enforcement Laws (Lemon Laws)

Replacement parts and accessories are covered by the Mercedes-Benz Parts and Accessories warranties. You can obtain information about this from any authorized Mercedes-Benz Center.

i Should you lose your Service and Warranty Information booklet, have an authorized Mercedes-Benz Center arrange for a replacement. It will be mailed to you.

Identification plates

Vehicle identification plate with vehicle identification number (VIN) and paint code number

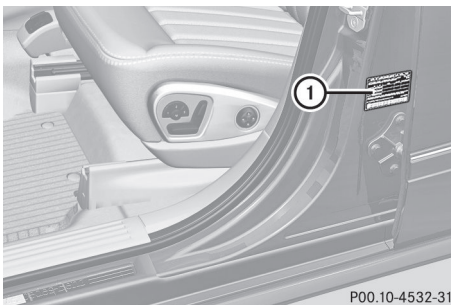

- ▶ Open the driver's door. You will see vehicle identification plate ①.

⁴⁴ Only vehicles with a gasoline engine.

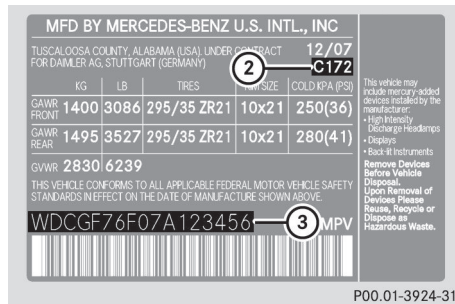

Example: vehicle identification plate (USA only)

- ② Paint code
- ③ VIN

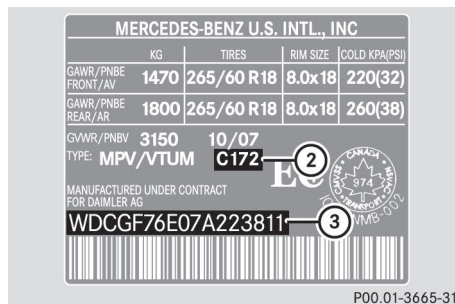

Example: vehicle identification plate (Canada only)

- ② Paint code
- ③ VIN
- i** The data shown on the identification plate is example data. This data is different for every vehicle and can deviate from the data shown here. You can find the data applicable to your vehicle on the vehicle's identification plate.

Vehicle identification number (VIN)

The vehicle identification number (VIN) can be found in the following locations:

- on the vehicle identification plate (▷ page 353)
- on the lower edge of the windshield (▷ page 354)

In addition to being stamped on the vehicle identification plate, the vehicle identification number (VIN) is also stamped onto the vehicle body.

It is located on the floor in front of the right-hand seat in the second row of seats.

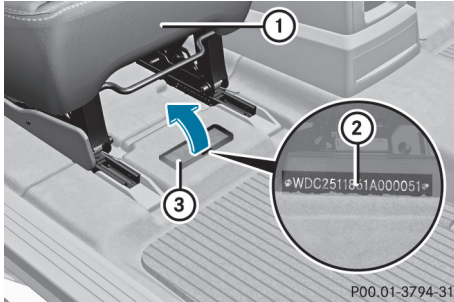

- ▶ Slide right-hand seat ① of the second row to its rearmost position.
- ▶ Fold floor covering ③ upwards. You will see vehicle identification number (VIN) ②.

Technical data

Engine number

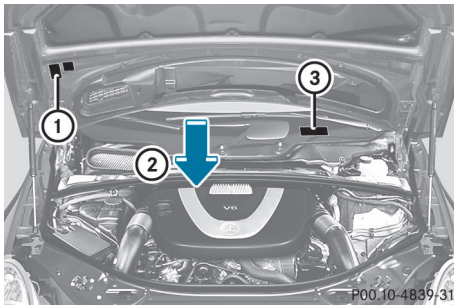

- ① Emission control information plate, including the certification of both federal and Californian emissions standards
- ② Engine number (stamped into the crankcase)
- ③ VIN (on the lower edge of the windshield)

Service products and capacities

Important safety notes

Service products include the following:

- fuels (e.g. gasoline, diesel)
- additives for exhaust gas aftertreatment (DEF)
- lubricants (e.g. engine oil, transmission oil)
- coolant
- brake fluid
- windshield washer fluid

Vehicle components and their respective lubricants must match. You should therefore only use products that have been tested and approved by Mercedes-Benz.

Information on tested and approved products can be obtained at a Mercedes-Benz Center or on the Internet at <http://www.mbusa.com> (USA only).

WARNING

Comply with all valid regulations with respect to handling, storing and disposing of service fluids. Otherwise, you could endanger persons or the environment.

Keep service fluids out of the reach of children.

For health reasons, you should prevent service fluids from coming into direct contact with your skin or clothing.

If a service fluid is swallowed, contact a physician immediately.

Capacities			
	Vehicle model	Capacity	Fuel, coolant, lubricants etc.
Engine oil and filter	R 350 BlueTEC	9.0 US qt (8.5 l)	Approved engine oils
	R 350	7.9 US qt (7.5 l)	
Cooling system	All models	Approx. 10.0 US qt (9.5 l)	MB 326.0 corrosion inhibitor/antifreeze agent
Tank capacity	All models	21.1 US gal (80.0 l)	Gasoline engines: premium-grade unleaded gasoline (at least 91 octane, average value between 96 RON/86 MON) Diesel engines: ULTRA-LOW SULFUR HIGHWAY DIESEL FUEL (ULSD, maximum sulfur content 15 ppm)
Reserve	All models	Approx. 3.4 US gal (13.0 l)	
DEF tank	R 350 BlueTEC	7.5 US gal (28.2 l)	DEF in accordance with ISO 22241
Air-conditioning system	All models	–	Refrigerant R134a and special PAG lubricant (never R 12)
Windshield/headlamp cleaning system	All models	7.4 US qt (7.0 l)	MB windshield washer concentrate ⁴⁵ (▷ page 360) Mixing ratio for washer fluid (▷ page 360)

⁴⁵ Mixed with water or premixed washer fluid with antifreeze protection.

Fuel

Important safety notes

WARNING

Gasoline and diesel fuels are highly flammable and poisonous. They burn violently and can cause serious injury.

Never allow sparks, flames or smoking materials near gasoline or diesel fuel!

Turn off the engine before refueling.

Whenever you are around gasoline or diesel fuel, avoid inhaling fumes and any skin or clothing contact. Extinguish all smoking materials.

Direct skin contact with fuels and the inhalation of fuel vapors are damaging your health.

Premium-grade unleaded gasoline

! To ensure the longevity and full performance of the engine, only premium-grade unleaded gasoline must be used. If no premium-grade unleaded gasoline is available and regular unleaded gasoline must be used, observe the following precautions:

- only fill the fuel tank to half full with regular unleaded gasoline and fill the rest with premium-grade unleaded gasoline as soon as possible.
- do not drive at the maximum speed.
- avoid sudden acceleration.
- when the vehicle is carrying a light load, e.g. two passengers without luggage, do not allow the engine to rev above 3000 rpm.
- when the vehicle is fully loaded or in mountainous terrain, do not depress the accelerator pedal further than $\frac{2}{3}$ of the pedal travel.

Fuel requirements

Gasoline engines

Use only premium-grade unleaded gasoline. The octane number should be at least 91. Details can be found on the gas pump. The octane number is the average value of the Research Octane Number (RON) and the Motor Octane Number (MON): $(RON + MON) / 2$, also known as knock resistance. Reformulated Gasoline (RFG) and/or unleaded gasoline with additives can be used if the concentration of the additives in the fuel does not exceed 10%, e.g.:

- Ethanol
- TAME
- ETBE
- IPA
- TBA

For MTBE, the concentration should not exceed 15%.

The concentration of methanol in gasoline including other additives must not exceed 3%. Using mixtures of methanol and ethanol is not permitted. Gasohol, a mixture of 10% ethanol and 90% unleaded gasoline, can be used.

All of these mix fuels must fulfill the fuel requirements, e.g.:

- knock resistance
- boiling point
- vapor pressure

Diesel engines – Important safety notes

! Only use commercially available ULTRA-LOW SULFUR DIESEL FUEL (ULSD, 15 ppm MAXIMUM SULFUR) that meets the ASTM D975 standard. Failure to use ULTRA-LOW SULFUR DIESEL FUEL (ULSD) can severely damage the vehicle's exhaust gas aftertreatment system.

! Do not fill the tank with gasoline. Do not blend diesel fuel with gasoline or kerosene. Otherwise, the fuel system and the engine could be damaged.

To prevent malfunctions, diesel fuel with improved flow characteristics is available in the winter months. Check with your gas station.

Information on the fuel grade can usually be found on the gas pump. If the information cannot be found on the gas pump, ask the gas station personnel. For further information, consult an authorized Mercedes-Benz Center or go to the Internet site <http://www.mbusa.com> (USA only).

Diesel engines – Fuels containing biodiesel (FAME [fatty acid methyl ester])

Mercedes-Benz USA approves the use of B5 (ULSD with a maximum of up to five percent by volume biodiesel) for all diesel engines with common rail direct injection (CDI) and BlueTEC.

Pure biodiesel and diesel fuels that have a higher percentage of biodiesel, e.g. B20, can damage the fuel system and the engine and are therefore not approved.

For further information, please ask the gas station personnel. The label on the gas pump must indicate clearly that the B5 biodiesel blend fulfills the ULSD standard. If the label is not clear, do not refuel the vehicle.

Do not refuel your vehicle with fuels unless they have been approved by Mercedes-Benz.

Additives in gasoline

One of the major problems with poor quality fuels is the creation of carbon deposits during the combustion process. Mercedes-Benz recommends that you use fuel brands containing additives that prevent the build-up of carbon deposits.

If you use fuels without these additives for an extended period of time, there may be a build up of carbon deposits, especially on the inlet valves and in the combustion chamber.

This could lead to engine running problems, e.g.:

- longer engine warm-up phase
- uneven idle

- engine noise
- misfiring
- loss of power

In areas where the availability of gasoline with relevant additives is not adequate, carbon deposits can form. In this case, Mercedes-Benz recommends the use of additives that have been approved for Mercedes-Benz vehicles.

Consult an authorized Mercedes-Benz Center or go to the Internet site

<http://www.mbusa.com> (USA only) for a list of approved products. Observe the instructions for use on the product label.

Do not mix other fuel additives with fuel. This causes unnecessary costs and could damage the engine.

- ❗ Do not refuel with low-grade fuel and do not use fuel additives that are not tested and approved for Mercedes-Benz vehicles. Damage to or malfunctions of the fuel system may otherwise occur.

DEF

Important safety notes

- ⓘ For BlueTEC vehicles only.

DEF is a non-flammable, non-toxic, colorless, odorless and water-soluble fluid.

- ❗ Only use DEF that complies with ISO 2224 1. Do not add any special additives to DEF and do not thin DEF with water. This could destroy the BlueTEC exhaust gas aftertreatment.

- ❗ Rinse surfaces that have come into contact with DEF immediately with water or remove DEF using a damp cloth and cold water. If the DEF has already crystallized, use a sponge and cold water to clean it. DEF residues crystallize after time and contaminate the affected surfaces.

High outside temperatures

If DEF heats up over 122 °F (50 °C) for longer periods, e.g. as a result of direct sunlight on the DEF reservoir, DEF can decompose. Ammonia vapors develop as a result.

WARNING

When opening the filler cap of the DEF tank ammonia gas vapors may escape. Refill DEF in a well ventilated area only. Ammonia gas vapors have a pungent odor and are particularly irritating for your skin, mucous membranes, and eyes. Inhaling ammonia gas vapors will cause burning eyes, nose, and throat, as well as coughing and watering eyes.

Low outside temperatures

DEF freezes at a temperature of approximately 12 °F (-11 °C). The vehicle is equipped with a DEF preheating system when it leaves the factory. Winter operation is therefore also guaranteed at temperatures below 12 °F (-11 °C).

Additives

 Only use DEF in accordance with ISO 22241. Do not use additives with DEF and do not dilute DEF with water. This may destroy the BlueTEC exhaust gas aftertreatment system.

Damage resulting from the use of additives or water is not covered by the Mercedes-Benz Limited Warranty.

Purity

Assuring the purity of DEF is particularly important with respect to avoiding malfunctions in the exhaust gas aftertreatment system.

If DEF is pumped out of the DEF tank, e.g. during repair work, it must not be returned to the tank. The purity of the fluid can no longer be guaranteed.

 Impurities in DEF, e.g. due to other service products, cleaning agents or dust,

lead to increased emission values, system malfunctions, catalytic converter damage or damage to the BlueTEC system.

Engine oil

Please bear the following in mind

The engine oils are matched to the performance of Mercedes-Benz engines and service intervals. You should therefore only use engine oils and oil filters that are approved for vehicles with maintenance systems.

For a list of approved engine oils and oil filters, consult an authorized Mercedes-Benz Center or go to the Internet site <http://www.mbusa.com> (USA only).

 Never use engine oil or an oil filter of a specification other than is necessary to fulfill the prescribed service intervals. Do not change the engine oil or oil filter in order to achieve longer replacement intervals than those prescribed. You could otherwise cause engine damage or damage to the exhaust gas aftertreatment.

Follow the instructions in the service interval display regarding the oil change. Otherwise, you may damage the engine and the exhaust gas aftertreatment.

The table shows which engine oils have been approved for your vehicle.

Model	Engine model	MB Approval
R 350 BlueTEC	642	229.51
R 350	276	229.5

 MB Approval is indicated on the oil containers.

Additives

 Do not use any additives in the engine oil. This could damage the engine.

Engine oil viscosity

Viscosity describes the flow characteristics of a fluid. If an engine oil has a high viscosity, this means that it is thick; a low viscosity means that it is thin.

Select an engine oil with an SAE (viscosity) classification suitable for the prevailing outside temperatures. The following table shows the correct SAE classification to be used. The low-temperature characteristics of engine oils can deteriorate significantly, e.g. as a result of aging, soot and fuel deposits. It is therefore strongly recommended that you carry out regular oil changes using an approved engine oil with the appropriate SAE classification.

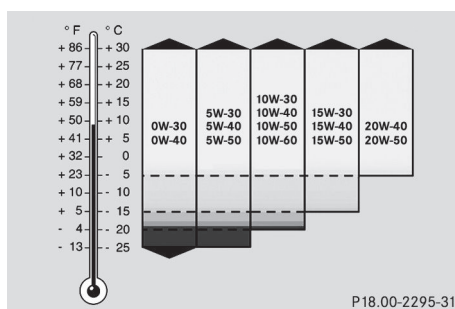

Refrigerant of the air-conditioning system

The air-conditioning system is filled with R134a refrigerant and a special PAG lubricant.

! Never use refrigerant R 12 (CFC) or mineral lubricants. Otherwise, you could damage the air-conditioning system.

Brake fluid

⚠ WARNING

The brake fluid constantly absorbs moisture from the air; this lowers its boiling point.

If the boiling point of the brake fluid is too low, vapor pockets may form in the brake system

when the brakes are applied hard (e.g. when driving downhill). This would impair braking efficiency.

You should have the brake fluid renewed at regular intervals. The brake fluid change intervals can be found in the Service Booklet.

Only use brake fluid approved by Mercedes-Benz. Information about approved brake fluids can be obtained from any authorized Mercedes-Benz Center.

Coolant

Important safety notes

The coolant is a mixture of water and antifreeze/corrosion inhibitor. It performs the following tasks:

- anti-corrosion protection
- antifreeze protection
- raising the boiling point

The engine cooling system is filled at the factory with coolant which contains an antifreeze/corrosion inhibitor that ensures protection down to approximately -35 °F (-37 °C).

! Only add coolant that has been premixed with the desired antifreeze protection. Otherwise, the engine could be damaged.

Further information on coolants and on filling can be found in the Mercedes-Benz Specifications for Service Products, MB Approval 310.1, e.g. on the Internet at <http://bevo.mercedes-benz.com>. You can also consult an authorized Mercedes-Benz Center.

! Always use a suitable coolant mixture, even in countries where high temperatures prevail.

Otherwise, the cooling system will not be sufficiently protected from corrosion, and the boiling point will be too low.

If the coolant has antifreeze protection down to -35 °F (-37 °C), the boiling point of the

coolant in the pressurized system is approximately 266 °F (130 °C).

Your vehicle has a range of aluminum components. Use of aluminum components in the engine make it necessary to specifically match the antifreeze/corrosion inhibitor in these systems in order to protect the aluminum parts. Using other antifreeze/corrosion inhibitors without these characteristics affects the service life.

The coolant must be used throughout the year in order to maintain the necessary corrosion protection and provide protection from overheating. In the Service Booklet, you can find information on the intervals for renewal.

The renewal interval is determined by the coolant type and the engine cooling system design. The renewal interval in the Service Booklet is only valid if the coolant is renewed or replenished with Mercedes-Benz approved products. Therefore, only use MB 326.0 antifreeze/corrosion inhibitor or another Mercedes-Benz approved product of the same specification.

Information on other products with the same specifications that are approved by Mercedes-Benz can be obtained at an authorized Mercedes-Benz Center or on the Internet at

<http://bevo.mercedes-benz.com>.

The coolant is checked at every maintenance interval at an authorized Mercedes-Benz Center.

The antifreeze/corrosion inhibitor concentration in the engine cooling system should:

- be at least 50%. This will protect the engine cooling system against freezing down to approximately -35 °F (-37 °C).
- not exceed 55% (antifreeze protection to -49 °F [-45 °C]); otherwise, heat will not dissipate as effectively.

If the coolant level is too low, MB 326.0 antifreeze/corrosion inhibitor should be added. Have the engine cooling system checked for possible leaks.

Windshield/headlamp cleaning system

WARNING

Washer solvent/antifreeze is highly flammable. Do not spill washer solvent/antifreeze on hot engine parts, because it may ignite and burn. You could be seriously burned.

Use MB SummerFit windshield washer concentrate at temperatures above freezing:

- ▶ Mix 1 part MB SummerFit with 100 parts water.

Use MB WinterFit windshield washer concentrate at temperatures below freezing:

- ▶ At temperatures down to 14 °F(- 10 °C): mix 1 part MB WinterFit with 2 parts water.
- ▶ At temperatures down to - 4 °F(- 20 °C): mix 1 part MB WinterFit with 1 part water.
- ▶ At temperatures down to - 20.2 °F(- 29 °C): mix 2 parts MB WinterFit with 1 part water.

 Only SummerFit and WinterFit can be mixed. Otherwise, the jets could become blocked.

Vehicle data

Vehicle data, R 350 BlueTEC

The data stated here refers specifically to a vehicle with standard equipment. Consult an authorized Mercedes-Benz Center for the data for all vehicle variants and trim levels.

Vehicle dimensions, R 350 BlueTEC

Vehicle length	203.3 in (5163 mm)
Vehicle width including exterior mirrors	86.0 in (2183 mm)

Vehicle dimensions, R 350 BlueTEC	
Vehicle height	65.6 in (1666 mm) ⁴⁶
Wheelbase	126.6 in (3215 mm)
Front track	64.5 in (1638 mm)
Rear track	64.4 in (1636 mm)
Ground clearance	5.9 in (150 mm) ⁴⁶
Turning circle	41.3 ft (12.6 m)

Vehicle weight, R 350	
Maximum roof load	Maximum 220 lb (100 kg)

Vehicle weight, R 350 BlueTEC	
Maximum roof load	Maximum 220 lb (100 kg)

Vehicle data, R 350

The data stated here refers specifically to a vehicle with standard equipment. Consult an authorized Mercedes-Benz Center for the data for all vehicle variants and trim levels.

Vehicle dimensions, R 350	
Vehicle length	203.3 in (5163 mm)
Vehicle width including exterior mirrors	86.0 in (2183 mm)
Vehicle height	65.5 in (1663 mm) ⁴⁷
Wheelbase	126.6 in (3215 mm)
Front track	64.5 in (1638 mm)
Rear track	64.4 in (1636 mm)
Ground clearance	6.0 in (152 mm) ⁴⁷
Turning circle	41.3 ft (12.6 m)

⁴⁶ These values refer to an unladen vehicle with standard equipment. On vehicles with the AIRMATIC package, the values vary according to the vehicle level.

⁴⁷ These values refer to an unladen vehicle with standard equipment. On vehicles with the AIRMATIC package, the values vary according to the vehicle level.

Publication details

Internet

Further information about Mercedes-Benz vehicles and about Daimler AG can be found on the following websites:

<http://www.mbusa.com> (USA only)

<http://www.mercedes-benz.ca> (Canada only)

Editorial office

Not to be reprinted, translated or otherwise reproduced, in whole or in part, without the written permission of Daimler AG.



2515845582

Order no. 6515 1846 13 Part no. 251 584 55 82 Edition A 2012